

FT9Y-B1382(3)

FT1A SERIES
Smart **AXIS**

Ladder Programming Manual

IDEC CORPORATION

SAFETY PRECAUTIONS

- Read the SmartAXIS Pro/Lite User's Manual to make sure of correct operation before starting installation, wiring, operation, maintenance, and inspection of the SmartAXIS.
- All SmartAXIS modules are manufactured under IDEC's rigorous quality control system, but users must add a backup or failsafe provision to the control system when using the SmartAXIS in applications where heavy damage or personal injury may be caused in case the SmartAXIS should fail.
- In this user's manual, safety precautions are categorized in order of importance to Warning and Caution:



Warning Warning notices are used to emphasize that improper operation may cause severe personal injury or death.

- The SmartAXIS is not designed for use in medical equipment, nuclear power, railways, aviation, passenger vehicle equipment, or similar applications requiring a high degree of reliability and safety. The SmartAXIS cannot be used for such applications.
- When using the SmartAXIS in applications not described above that require a high degree of reliability in terms of functionality and precision, appropriate measures such as failsafe mechanisms and redundant mechanisms must be taken for a system containing the SmartAXIS.
- Emergency stop and interlocking circuits must be configured outside the SmartAXIS.
- If relays or transistors in the SmartAXIS output circuits should fail, outputs may remain in the on or off state. For output signals which may cause serious accidents, configure monitor circuits outside the SmartAXIS.
- The SmartAXIS self-diagnostic function may detect internal circuit or program errors, stop programs, and turn outputs off. Configure circuits so that the system containing the SmartAXIS is not jeopardized when outputs turn off.
- Turn off power to the SmartAXIS before installation, removal, wiring, maintenance, and inspection of the SmartAXIS. Failure to turn power off may cause electrical shocks or fire hazard.
- Special expertise is required to install, wire, program, and operate the SmartAXIS. People without such expertise must not use the SmartAXIS.
- Install the SmartAXIS according to the instructions described in SmartAXIS Pro/Lite user's manual. Improper installation will result in falling, failure, or malfunction of the SmartAXIS.



Caution Caution notices are used where inattention might cause personal injury or damage to equipment.

- The SmartAXIS is designed for installation in a cabinet. Do not install the SmartAXIS outside a cabinet.
- Install the SmartAXIS in environments described in SmartAXIS Pro/Lite user's manual. If the SmartAXIS is used in places where the SmartAXIS is subjected to high-temperature, high-humidity, condensation, corrosive gases, excessive vibrations, and excessive shocks, then electrical shocks, fire hazard, or malfunction will result.
- The environment for using the SmartAXIS is "Pollution degree 2." Use the SmartAXIS in environments of pollution degree 2 (according to IEC 60664-1).
- While moving or transporting prevent the SmartAXIS from falling, otherwise damage or malfunction of the SmartAXIS will result.
- Wiring must use lead sizes that are appropriate for the applied voltage and current. Terminal screws must be tightened with the prescribed tightening torque.
- Prevent metal fragments and pieces of wire from dropping inside the SmartAXIS housing. Put a cover on the SmartAXIS modules during installation and wiring. Ingress of such fragments and chips may cause fire hazard, damage, or malfunction.
- Use a power supply of the rated value. Use of the wrong power supply may cause fire hazard.
- Use an IEC 60127-approved fuse on the power line outside the SmartAXIS. This is required when equipment containing the SmartAXIS is designed for use in Europe.
- Use an IEC 60127-approved fuse on the output circuit. This is required when equipment containing the SmartAXIS is designed for use in Europe.
- Use an EU-approved circuit breaker. This is required when equipment containing the SmartAXIS is destined for Europe.
- Make sure of safety before starting and stopping the SmartAXIS or when operating the SmartAXIS to force outputs on or off. Incorrect operation of the SmartAXIS may cause machine damage or accidents.
- Do not connect the ground wire directly to the SmartAXIS. Connect a protective ground to the cabinet containing the SmartAXIS using an M4 or larger screw. This is required when equipment containing the SmartAXIS is designed for use in Europe.
- Do not disassemble, repair, or modify the SmartAXIS modules.
- The SmartAXIS contains electronic parts and batteries. When disposing of the SmartAXIS, do so in accordance with national and local regulations.

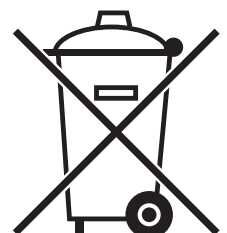

ABOUT THIS MANUAL

This user's manual describes basic and advanced instructions and the usage of software for SmartAXIS ladder programming.

Chapter 1: Operation Basics

General information about simple operating procedures from creating a user program using WindLDR on a computer to monitoring the SmartAXIS operation.

Chapter 2: Ladder Program Monitoring on the SmartAXIS

Monitoring the ladder program in the SmartAXIS.

Chapter 3: Device Addresses

Device addresses available for the SmartAXIS to program basic and advanced instructions. Special internal relays and special data registers are also described.

Chapter 4: Instructions Reference

List of all basic and advanced instructions and general rules of using advanced instructions, terms, data types, and formats used for advanced instructions.

Chapter 5: Basic Instructions

Programming of the basic instructions, available devices, and sample programs.

Chapter 6 through Chapter 26:

Detailed descriptions for advanced instructions.

Appendix

Additional information about execution times and byte sizes for instructions.

Index

Alphabetical listing of key words.

Publication history

| | |
|--------------|----------------|
| March 2013 | First Edition |
| August 2013 | Second Edition |
| October 2013 | Third Edition |
| August 2014 | Fourth Edition |

Trademarks

SmartAXIS is a trademark of IDEC Corporation.

IMPORTANT INFORMATION

Under no circumstances shall IDEC Corporation be held liable or responsible for indirect or consequential damages resulting from the use of or the application of IDEC PLC components, individually or in combination with other equipment.

All persons using these components must be willing to accept responsibility for choosing the correct component to suit their application and for choosing an application appropriate for the component, individually or in combination with other equipment.

All diagrams and examples in this manual are for illustrative purposes only. In no way does including these diagrams and examples in this manual constitute a guarantee as to their suitability for any specific application. To test and approve all programs, prior to installation, is the responsibility of the end user.

RELATED MANUALS

The following manuals related to the SmartAXIS are available. Refer to them in conjunction with this manual.

| Type No. | Manual Name | Description |
|------------------|---|---|
| FT9Y-B1378 | SmartAXIS Pro/Lite User's Manual | Describes product specifications, installation and wiring instructions, instructions for basic programming operations and special functions, device and instruction lists, communication functions, and troubleshooting procedures for the SmartAXIS Pro/Lite series. |
| FT9Y-B1382 | SmartAXIS Ladder Programming Manual (this manual) | Describes basic operations for ladder programming, instructions for editing and monitoring ladders on the SmartAXIS, available devices and instruction lists, and details of each instruction. |
| FT9Y-B1386 | SmartAXIS FBD Programming Manual | Describes basic operations for function block programming, device and function block lists, and details of each function block. |
| FT9Y-B1390 | SmartAXIS Touch User's Manual | Describes product specifications, installation and wiring instructions, instructions for setting basic programming actions and special functions, device and instruction lists, communication functions, and troubleshooting procedures for the Touch series. |
| WindLDR Help | | Describes usage instructions for WindLDR, programming software for the SmartAXIS Pro/Lite series. |
| WindO/I-NV3 Help | | Describes programming for the SmartAXIS Touch series, and usage instructions for the WindO/I-NV3 configuration software. |

NAMES AND ABBREVIATIONS USED IN THIS MANUAL

Model Names

| Name Used in this Manual | Description (Detailed Type No.) |
|--------------------------|---|
| SmartAXIS | FT1A programmable logic controllers. |
| SmartAXIS Lite | Modules without LCD. (FT1A-B12RA, FT1A-B12RC, FT1A-B24RA, FT1A-B24RC, FT1A-B40RKA, FT1A-B40RSA, FT1A-B40RC, FT1A-B48KA, FT1A-B48SA, FT1A-B48KC, FT1A-B48SC) |
| SmartAXIS Pro | Modules with LCD. (FT1A-H12RA, FT1A-H12RC, FT1A-H24RA, FT1A-H24RC, FT1A-H40RKA, FT1A-H40RSA, FT1A-H40RC, FT1A-H48KA, FT1A-H48SA, FT1A-H48KC, FT1A-H48SC) |
| SmartAXIS Touch | Modules that extend the functionality of display. (FT1A-M12RA-W, FT1A-M12RA-B, FT1A-M12RA-S, FT1A-C12RA-W, FT1A-C12RA-B, FT1A-C12RA-S, FT1A-M14KA-W, FT1A-M14KA-B, FT1A-M14KA-S, FT1A-C14KA-W, FT1A-C14KA-B, FT1A-C14KA-S, FT1A-M14SA-W, FT1A-M14SA-B, FT1A-M14SA-S, FT1A-C14SA-W, FT1A-C14SA-B, FT1A-C14SA-S) |
| 12-I/O type | SmartAXIS Pro and Lite models with 12 I/O points. (FT1A-B12RA, FT1A-B12RC, FT1A-H12RA, FT1A-H12RC) |
| 24-I/O type | SmartAXIS Pro and Lite models with 24 I/O points. (FT1A-B24RA, FT1A-B24RC, FT1A-H24RA, FT1A-H24RC) |
| 40-I/O type | SmartAXIS Pro and Lite models with 40 I/O points. (FT1A-B40RKA, FT1A-B40RSA, FT1A-B40RC, FT1A-H40RKA, FT1A-H40RSA, FT1A-H40RC) |
| 48-I/O type | SmartAXIS Pro and Lite models with 48 I/O points. (FT1A-B48KA, FT1A-B48SA, FT1A-B48KC, FT1A-B48SC, FT1A-H48KA, FT1A-H48SA, FT1A-H48KC, FT1A-H48SC) |
| AC power type | SmartAXIS Pro and Lite models with an AC power supply. (FT1A-B12RC, FT1A-H12RC, FT1A-B24RC, FT1A-H24RC, FT1A-B40RC, FT1A-H40RC, FT1A-B48KC, FT1A-B48SC, FT1A-H48KC, FT1A-H48SC) |
| DC power type | SmartAXIS Pro and Lite models with a DC power supply. (FT1A-B12RA, FT1A-H12RA, FT1A-B24RA, FT1A-H24RA, FT1A-B40RKA, FT1A-H40RKA, FT1A-B40RSA, FT1A-H40RSA, FT1A-B48KA, FT1A-B48SA, FT1A-H48KA, FT1A-H48SA) |

TABLE OF CONTENTS

| | | |
|-------------------|--|-----------|
| | Safety Precautions..... | Preface-1 |
| | About This Manual..... | Preface-2 |
| | Related Manuals..... | Preface-3 |
| | Names and Abbreviations Used in this Manual | Preface-4 |
| CHAPTER 1: | Operation Basics | |
| | Start WindLDR | 1-1 |
| | PLC Selection | 1-2 |
| | Create Ladder Program..... | 1-3 |
| | Save Project..... | 1-6 |
| | Simulate Operation..... | 1-7 |
| | Download Program..... | 1-7 |
| | Monitor Operation | 1-8 |
| | Quit WindLDR | 1-8 |
| CHAPTER 2: | Ladder Program Monitoring on the SmartAXIS | |
| | Basic Operations | 2-1 |
| | Ladder Program Monitor | 2-3 |
| | Using the Ladder Program Monitor..... | 2-4 |
| CHAPTER 3: | Device Addresses | |
| | Device Addresses | 3-1 |
| | Special Internal Relays..... | 3-2 |
| | Special Data Registers | 3-8 |
| CHAPTER 4: | Instructions Reference | |
| | Basic Instruction List..... | 4-1 |
| | Advanced Instruction List..... | 4-3 |
| | Advanced Instruction Applicable SmartAXIS | 4-6 |
| | Structure of an Advanced Instruction | 4-9 |
| | Input Condition for Advanced Instructions..... | 4-9 |
| | Source and Destination Devices..... | 4-9 |
| | Using Timer or Counter as Source Device..... | 4-9 |
| | Using Timer or Counter as Destination Device | 4-9 |
| | Data Types for Advanced Instructions..... | 4-10 |
| | Discontinuity of Device Areas | 4-14 |
| | NOP (No Operation) | 4-14 |
| CHAPTER 5: | Basic Instructions | |
| | LOD (Load) and LODN (Load Not) | 5-1 |
| | OUT (Output) and OUTN (Output Not)..... | 5-1 |
| | SET and RST (Reset) | 5-3 |
| | AND and ANDN (And Not)..... | 5-4 |
| | OR and ORN (Or Not)..... | 5-4 |
| | AND LOD (Load) | 5-5 |
| | OR LOD (Load) | 5-5 |
| | BPS (Bit Push), BRD (Bit Read), and BPP (Bit Pop)..... | 5-6 |
| | TML, TIM, TMH, and TMS (Timer) | 5-7 |
| | TMLO, TIMO, TMHO, and TMSO (Off-Delay Timer) | 5-10 |
| | CNT, CDP, and CUD (Counter)..... | 5-11 |
| | CNTD, CDPD, and CUDD (Double-Word Counter)..... | 5-14 |
| | CC= and CC>= (Counter Comparison)..... | 5-18 |
| | DC= and DC>= (Data Register Comparison) | 5-20 |
| | SFR and SFRN (Forward and Reverse Shift Register)..... | 5-22 |
| | SOTU and SOTD (Single Output Up and Down) | 5-26 |
| | MCS and MCR (Master Control Set and Reset) | 5-27 |
| | JMP (Jump) and JEND (Jump End) | 5-29 |
| | END | 5-30 |

| | | |
|--------------------|---|-------|
| | Restriction on Ladder Programming..... | 5-31 |
| CHAPTER 6: | <i>Move Instructions</i> | |
| | MOV (Move)..... | 6-1 |
| | MOVN (Move Not)..... | 6-5 |
| | IMOV (Indirect Move)..... | 6-6 |
| | IMOVN (Indirect Move Not)..... | 6-8 |
| | BMOV (Block Move)..... | 6-9 |
| | IBMV (Indirect Bit Move)..... | 6-10 |
| | IBMVN (Indirect Bit Move Not)..... | 6-12 |
| | NSET (N Data Set)..... | 6-13 |
| | NRS (N Data Repeat Set)..... | 6-14 |
| | XCHG (Exchange)..... | 6-15 |
| | TCCST (Timer/Counter Current Value Store)..... | 6-16 |
| CHAPTER 7: | <i>Data Comparison Instructions</i> | |
| | CMP= (Compare Equal To)..... | 7-1 |
| | CMP<> (Compare Unequal To)..... | 7-1 |
| | CMP< (Compare Less Than)..... | 7-1 |
| | CMP> (Compare Greater Than)..... | 7-1 |
| | CMP<= (Compare Less Than or Equal To)..... | 7-1 |
| | CMP>= (Compare Greater Than or Equal To)..... | 7-1 |
| | ICMP>= (Interval Compare Greater Than or Equal To)..... | 7-6 |
| | LC= (Load Compare Equal To)..... | 7-8 |
| | LC<> (Load Compare Unequal To)..... | 7-8 |
| | LC< (Load Compare Less Than)..... | 7-8 |
| | LC> (Load Compare Greater Than)..... | 7-8 |
| | LC<= (Load Compare Less Than or Equal To)..... | 7-8 |
| | LC>= (Load Compare Greater Than or Equal To)..... | 7-8 |
| CHAPTER 8: | <i>Binary Arithmetic Instructions</i> | |
| | ADD (Addition)..... | 8-1 |
| | SUB (Subtraction)..... | 8-1 |
| | MUL (Multiplication)..... | 8-1 |
| | DIV (Division)..... | 8-1 |
| | INC (Increment)..... | 8-13 |
| | DEC (Decrement)..... | 8-13 |
| | ROOT (Root)..... | 8-14 |
| | SUM (Sum)..... | 8-15 |
| CHAPTER 9: | <i>Boolean Computation Instructions</i> | |
| | ANDW (AND Word)..... | 9-1 |
| | ORW (OR Word)..... | 9-1 |
| | XORW (Exclusive OR Word)..... | 9-1 |
| CHAPTER 10: | <i>Shift / Rotate Instructions</i> | |
| | SFTL (Shift Left)..... | 10-1 |
| | SFTR (Shift Right)..... | 10-3 |
| | BCDLS (BCD Left Shift)..... | 10-5 |
| | WSFT (Word Shift)..... | 10-7 |
| | ROTL (Rotate Left)..... | 10-8 |
| | ROTR (Rotate Right)..... | 10-10 |
| CHAPTER 11: | <i>Data Conversion Instructions</i> | |
| | HTOB (Hex to BCD)..... | 11-1 |
| | BTOH (BCD to Hex)..... | 11-3 |
| | HTOA (Hex to ASCII)..... | 11-5 |
| | ATOH (ASCII to Hex)..... | 11-7 |
| | BTOA (BCD to ASCII)..... | 11-9 |
| | ATOB (ASCII to BCD)..... | 11-12 |

| | | |
|--------------------|---|-------|
| | ENCO (Encode) | 11-15 |
| | DECO (Decode) | 11-16 |
| | BCNT (Bit Count) | 11-17 |
| | ALT (Alternate Output) | 11-18 |
| | CVDT (Convert Data Type) | 11-19 |
| | DTDV (Data Divide) | 11-21 |
| | DTCB (Data Combine) | 11-22 |
| | SWAP (Data Swap) | 11-23 |
| CHAPTER 12: | <i>Week Programmer Instructions</i> | |
| | WEEK (Weekly Timer) | 12-1 |
| | YEAR (Yearly Timer) | 12-11 |
| CHAPTER 13: | <i>Display Instructions</i> | |
| | MSG (Message) | 13-1 |
| CHAPTER 14: | <i>Program Branching Instructions</i> | |
| | LABEL (Label) | 14-1 |
| | LJMP (Label Jump) | 14-1 |
| | LCAL (Label Call) | 14-3 |
| | LRET (Label Return) | 14-3 |
| | DJNZ (Decrement Jump Non-zero) | 14-5 |
| CHAPTER 15: | <i>Refresh Instructions</i> | |
| | IOREF (I/O Refresh) | 15-1 |
| | HSCRF (High-speed Counter Refresh) | 15-3 |
| CHAPTER 16: | <i>Interrupt Control Instructions</i> | |
| | DI (Disable Interrupt) | 16-1 |
| | EI (Enable Interrupt) | 16-1 |
| CHAPTER 17: | <i>Coordinate Conversion Instructions</i> | |
| | XYFS (XY Format Set) | 17-1 |
| | CVXTY (Convert X to Y) | 17-2 |
| | CVYTX (Convert Y to X) | 17-3 |
| CHAPTER 18: | <i>Average Instructions</i> | |
| | AVRG (Average) | 18-1 |
| CHAPTER 19: | <i>Pulse Output Instructions</i> | |
| | PULS (Pulse Output) | 19-1 |
| | PWM (Variable Duty Cycle Pulse Output) | 19-8 |
| | RAMP (Trapezoidal Control) | 19-15 |
| | ZRN (Zero Return) | 19-26 |
| | ARAMP (RAMP with Table) | 19-32 |
| CHAPTER 20: | <i>Dual / Teaching Timer Instructions</i> | |
| | DTML (1-sec Dual Timer) | 20-1 |
| | DTIM (100-ms Dual Timer) | 20-1 |
| | DTMH (10-ms Dual Timer) | 20-1 |
| | DTMS (1-ms Dual Timer) | 20-1 |
| | TTIM (Teaching Timer) | 20-3 |
| CHAPTER 21: | <i>Trigonometric Function Instructions</i> | |
| | RAD (Degree to Radian) | 21-1 |
| | DEG (Radian to Degree) | 21-2 |
| | SIN (Sine) | 21-3 |
| | COS (Cosine) | 21-4 |
| | TAN (Tangent) | 21-5 |
| | ASIN (Arc Sine) | 21-6 |
| | ACOS (Arc Cosine) | 21-7 |

TABLE OF CONTENTS

| | | |
|--------------------|---|-------|
| | ATAN (Arc Tangent)..... | 21-8 |
| CHAPTER 22: | Logarithm / Power Instructions | |
| | LOGE (Natural Logarithm) | 22-1 |
| | LOG10 (Common Logarithm) | 22-2 |
| | EXP (Exponent) | 22-3 |
| | POW (Power)..... | 22-4 |
| CHAPTER 23: | File Data Processing Instructions | |
| | FIFO (FIFO Format)..... | 23-1 |
| | FIEX (First-In Execute)..... | 23-3 |
| | FOEX (First-Out Execute)..... | 23-3 |
| | NDSRC (N Data Search) | 23-5 |
| CHAPTER 24: | Clock Instructions | |
| | TADD (Time Addition) | 24-1 |
| | TSUB (Time Subtraction) | 24-5 |
| | HTOS (HMS to Sec)..... | 24-9 |
| | STOH (Sec to HMS)..... | 24-10 |
| | HOUR (Hour Meter) | 24-11 |
| CHAPTER 25: | User Communication Instructions | |
| | TXD (Transmit)..... | 25-1 |
| | RXD (Receive) | 25-7 |
| | ETXD (User Communication Transmit over Ethernet)..... | 25-21 |
| | ERXD (User Communication Receive over Ethernet) | 25-21 |
| CHAPTER 26: | Data Log Instructions | |
| | DLOG (Data Log) | 26-1 |
| | TRACE (Data Trace) | 26-8 |
| CHAPTER 27: | Script | |
| | SCRPT (Script)..... | 27-1 |
| CHAPTER 28: | PID Instruction | |
| | PID (PID Instruction) | 28-1 |
| | PID Monitor | 28-16 |
| APPENDIX | | |
| | Execution Times for Instructions | A-1 |
| | Breakdown of END Processing Time | A-5 |
| | Instruction Bytes..... | A-5 |
| INDEX | | |

1: OPERATION BASICS

Introduction

This chapter describes basic procedures for operating WindLDR, software required for programming and maintenance of the SmartAXIS Pro/Lite series.

Note: SmartAXIS Touch series use WindO/I-NV3 for programming. See the SmartAXIS Touch User's Manual for instructions for programming and basic operation of WindO/I-NV3 with the Touch series.

Start WindLDR

From the Start menu of Windows, select **Programs > Automation Organizer V2 > WindLDR > WindLDR**.

WindLDR starts and a blank ladder editing screen appears with menus and tool bars shown on top of the screen.

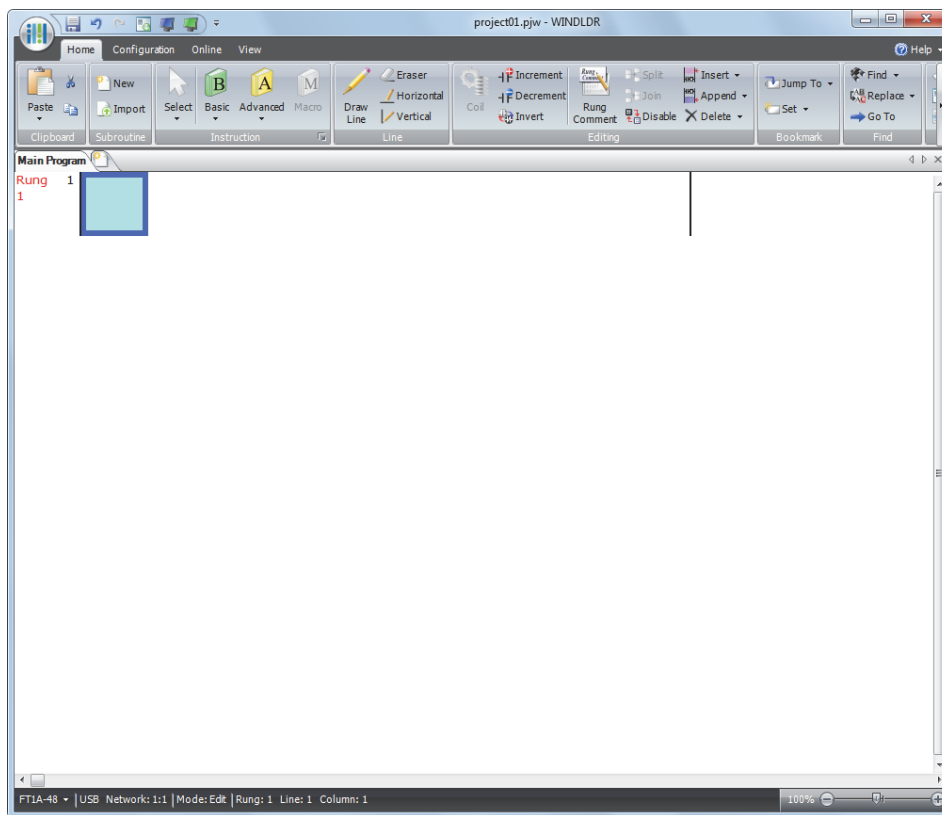

PLC Selection

Before programming a user program in WindLDR, select a PLC type.

1. Select **Configuration** from the WindLDR menu bar, then select **PLC Type**.

The PLC Selection dialog box appears.

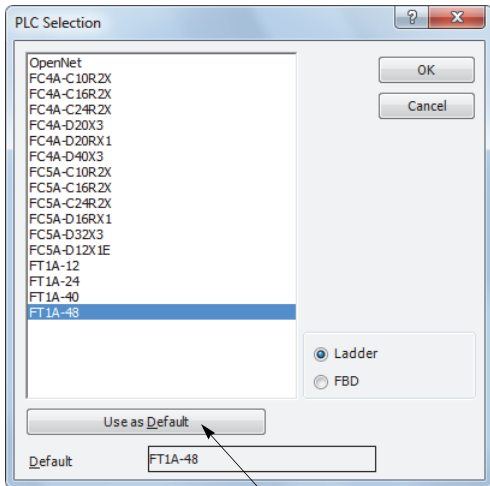

If the Use as Default button is pressed, then the same PLC will be selected as default when WindLDR is started next time.

| PLC Selection Option | SmartAXIS Type No. |
|----------------------|--|
| FT1A-12 | FT1A-H12RA FT1A-B12RA FT1A-H12RC FT1A-B12RC |
| FT1A-24 | FT1A-H24RA FT1A-B24RA FT1A-H24RC FT1A-B24RC |
| FT1A-40 | FT1A-H40RKA FT1A-H40RSA FT1A-B40RKA FT1A-B40RSA FT1A-H40RC FT1A-B40RC |
| FT1A-48 | FT1A-H48KA FT1A-H48SA FT1A-B48KA FT1A-B48SA FT1A-H48KC FT1A-H48SC FT1A-B48KC FT1A-B48SC |
| FT1A Touch | FT1A-M12RA-W FT1A-M12RA-B FT1A-M12RA-S FT1A-C12RA-W FT1A-C12RA-B FT1A-C12RA-S FT1A-M14KA-W FT1A-M14KA-B FT1A-M14KA-S FT1A-C14KA-W FT1A-C14KA-B FT1A-C14KA-S FT1A-M14SA-W FT1A-M14SA-B FT1A-M14SA-S FT1A-C14SA-W FT1A-C14SA-B FT1A-C14SA-S |

2. Select a PLC type in the selection box, select **Ladder** as the programming language.
3. Click **OK**.

Create Ladder Program

This section describes the procedure for creating a simple ladder program in WindLDR.

Note: See "Instructions Reference" on page 4-1 for details on basic and advanced instructions.

Sample User Program

Create a sample program using WindLDR that performs the following operation:

When only input I0 is turned on, output Q0 is turned on.

When only input I1 is turned on, output Q1 is turned on.

When both inputs I0 and I1 are turned on, output Q2 flashes in 1-sec increments.

| Rung No. | Input I0 | Input I1 | Output Operation |
|----------|----------|----------|--|
| 1 | ON | OFF | Output Q0 is turned ON. |
| 2 | OFF | ON | Output Q1 is turned ON. |
| 3 | ON | ON | Output Q2 flashes in 1-sec increments. |

Note: One collection of a group of instructions that control output or advanced instructions is called a rung. WindLDR manages programs in rung units. Function descriptions can be configured as rung comments for individual rungs.

Start WindLDR

From the Start menu of Windows, select **Programs > Automation Organizer V2 > WindLDR > WindLDR**.

WindLDR starts and a blank ladder editing screen appears with menus and tool bars shown on top of the screen.

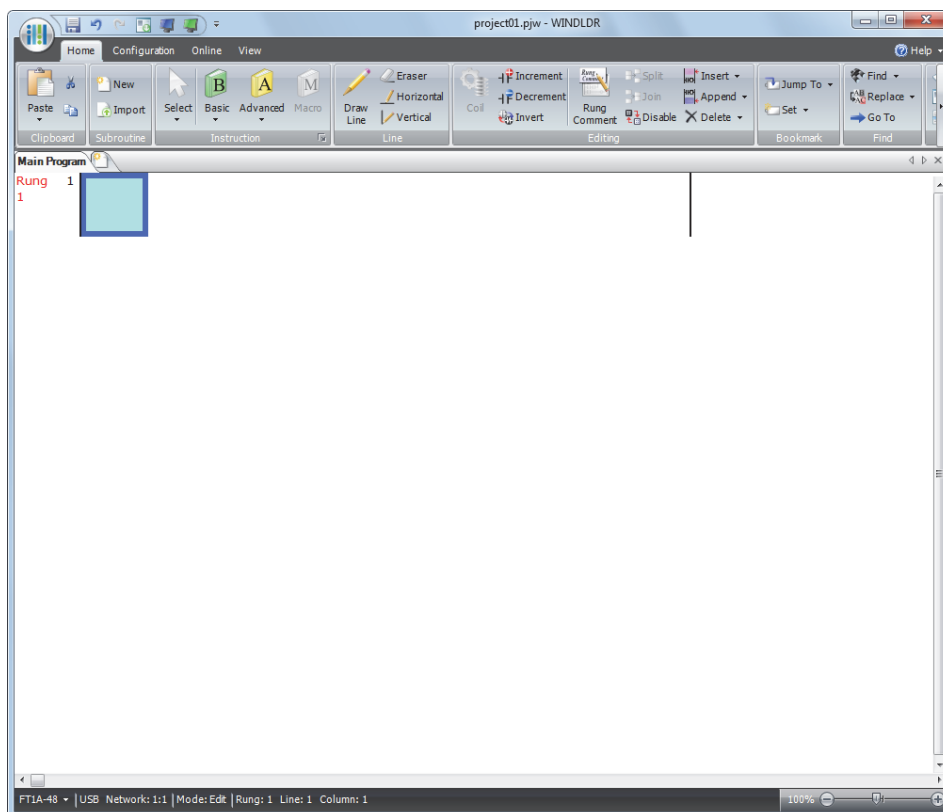

Edit User Program Rung by Rung

Start the user program with the LOD instruction by inserting a NO contact of input I0.

1. From the WindLDR menu bar, select **Home > Basic > A (Normally Open)**.

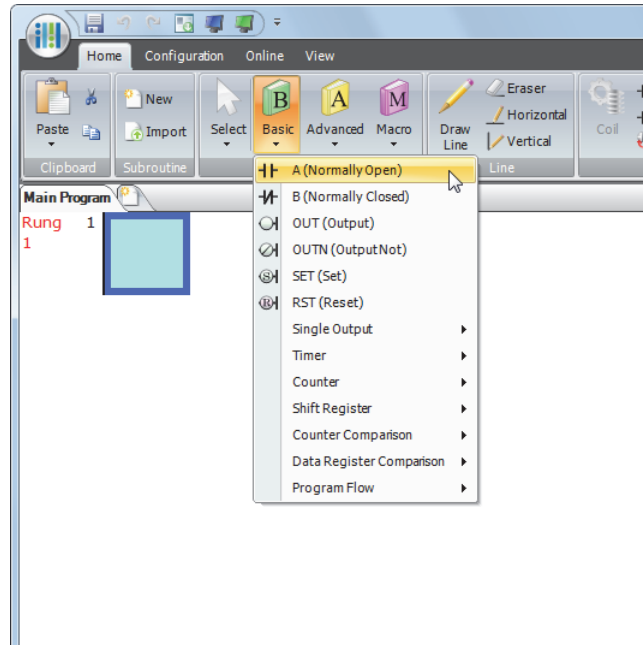

2. Move the mouse pointer to the first column of the first line where you want to insert a NO contact, and click the left mouse button.

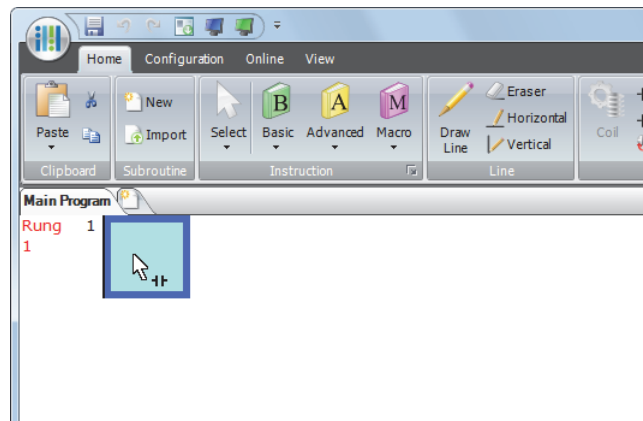

Note: Another method to insert a NO (or NC) contact is to move the mouse pointer where you want to insert the contact, and type A (or B). The Normally Open dialog box appears.

3. Enter **I0** in the Tag Name field, and click **OK**.

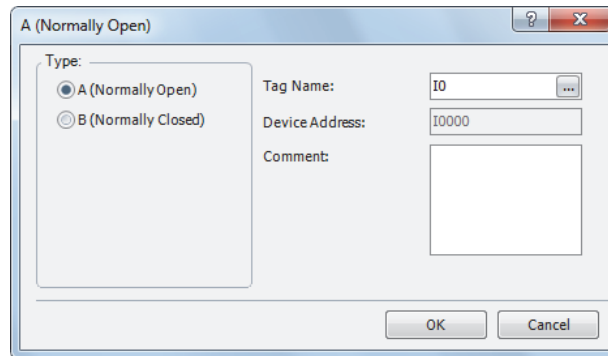

A NO contact of input I0 is programmed in the first column of the first ladder line. Next, program the ANDN instruction by inserting a NC contact of input I1.

4. From the WindLDR menu bar, select **Home > Basic > B (Normally Closed)**.
5. Move the mouse pointer to the second column of the first ladder line where you want to insert a NC contact, and click the left mouse button. The Normally Closed dialog box appears.
6. Enter **I1** in the Tag Name field, and click **OK**. A NC contact of input I1 is programmed in the second column of the first ladder line. At the end of the first ladder line, program the OUT instruction by inserting a NO coil of output Q0.
7. From the WindLDR menu bar, select **Home > Basic > OUT (Output)**.
8. Move the mouse pointer to the third column of the first ladder line where you want to insert an output coil, and click the left mouse button.

Note: Another method to insert an instruction (either basic or advanced) is to type the instruction symbol, OUT, where you want to insert the instruction.

The Output dialog box appears.

9. Enter **Q0** in the Tag Name field, and click **OK**. A NO output coil of output Q0 is programmed in the right-most column of the first ladder line. This completes programming for rung 1.

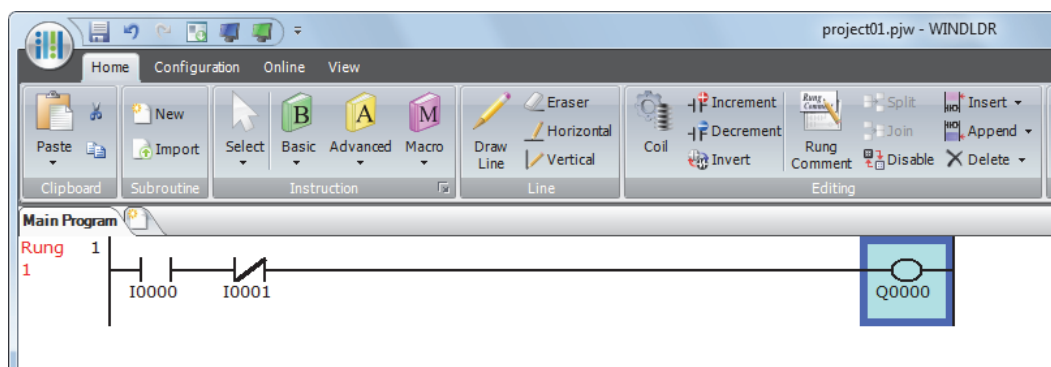

Continue programming for rungs 2 and 3 by repeating similar procedures.

A new rung is inserted by pressing the **Enter** key while the cursor is on the preceding rung. A new rung can also be inserted by selecting **Home > Append > Append a Rung**.

1: OPERATION BASICS

When completed, the ladder program looks like below.

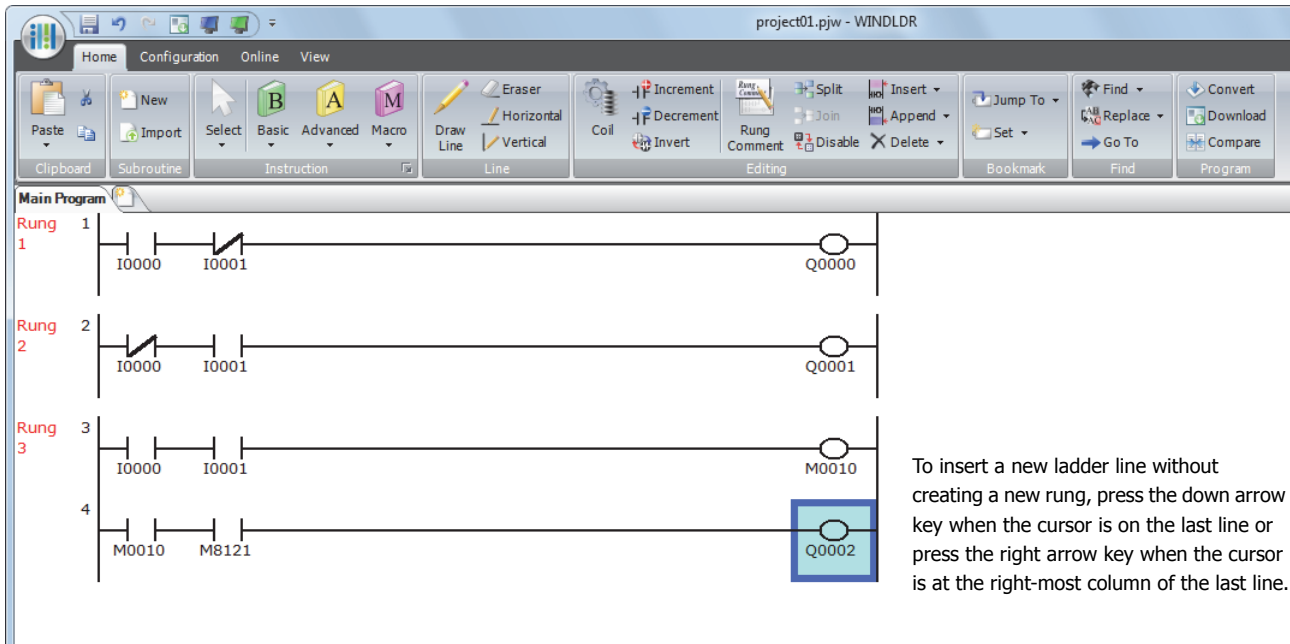

The ladder program can be checked to see if it contains any user program syntax error.

10. From the menu bar, select **Home > Convert (above Program)**.

When the instruction symbols are connected correctly, conversion is completed successfully. If any error is found, the errors are listed on the screen. Then, make corrections as necessary.

Now, save the file with a new name.

Save Project

1. Select the WindLDR application button at the upper-left corner of the WindLDR screen, followed by **Save**, and type **TEST01** in the File Name field. Change the Folder or Drive as necessary.

Simulate Operation

Before downloading the user program, you can simulate the operation on the WindLDR screen without connecting the SmartAXIS. From the WindLDR menu bar, select **Online > Simulation**. The Simulation screen appears.

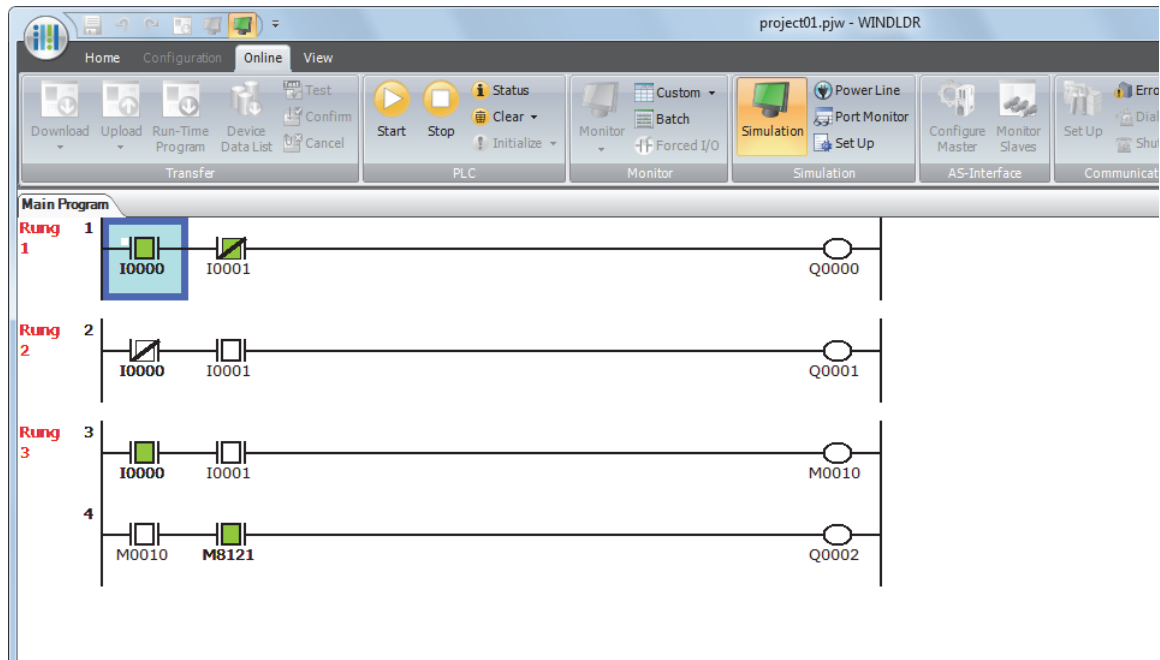

To change an input status, place the mouse pointer on the input and right-click the mouse. In the pop-up menu, select Set or Reset to set or reset the input.

To quit simulation, from the WindLDR menu bar, select **Online > Simulation**.

Download Program

You can download the user program from WindLDR running on a computer to the SmartAXIS.

User programs can be downloaded to the SmartAXIS from WindLDR using USB or Ethernet. This section describes the procedure from configuring communication settings to downloading a user program to the SmartAXIS via USB.

To use USB, the SmartAXIS USB port must be connected to a computer using a USB cable.

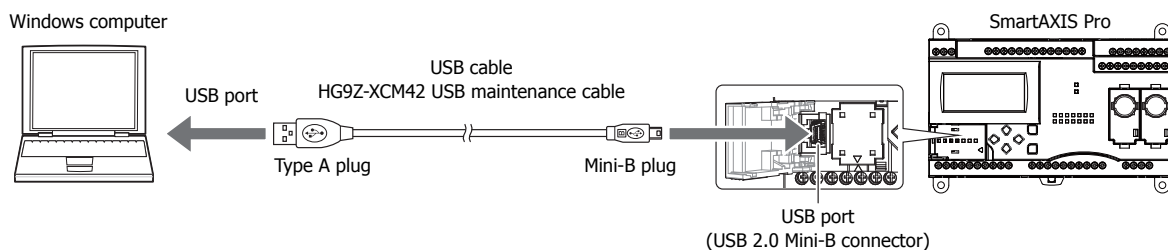

Note: In order for WindLDR to communicate with the SmartAXIS via USB, a dedicated USB driver must be installed on the computer. See the "Appendix" of the SmartAXIS Pro/Lite User's Manual for driver installation procedure.

1. From the WindLDR menu bar, select **Online > Set Up**.
2. The Communication Settings dialog box appears. Click the **USB** tab and then click **OK**. The communication method is now set to USB. Next, download a user program.
3. From the WindLDR menu bar, select **Online > Download**. The Download dialog box appears, then click **OK**. The user program is downloaded to the SmartAXIS.

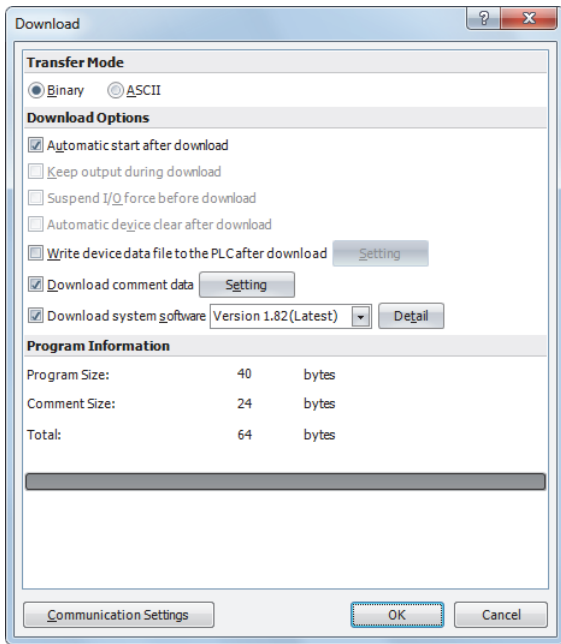

Note: The Download dialog box can also be opened by selecting **Home > Download**.

Note: When downloading a user program, all values and selections in the Function Area Settings are also downloaded to the SmartAXIS. For details on function settings, see Chapter 5 “Special Functions” in the SmartAXIS Pro/Lite User’s Manual.

Monitor Operation

Another powerful function of WindLDR is to monitor the PLC operation on the computer. The input and output status of the sample program can be monitored in the ladder diagram.

From the WindLDR menu bar, select **Online > Monitor > Monitor**.

When both inputs I0 and I1 are on, the ladder diagram on the monitor screen looks as follows:

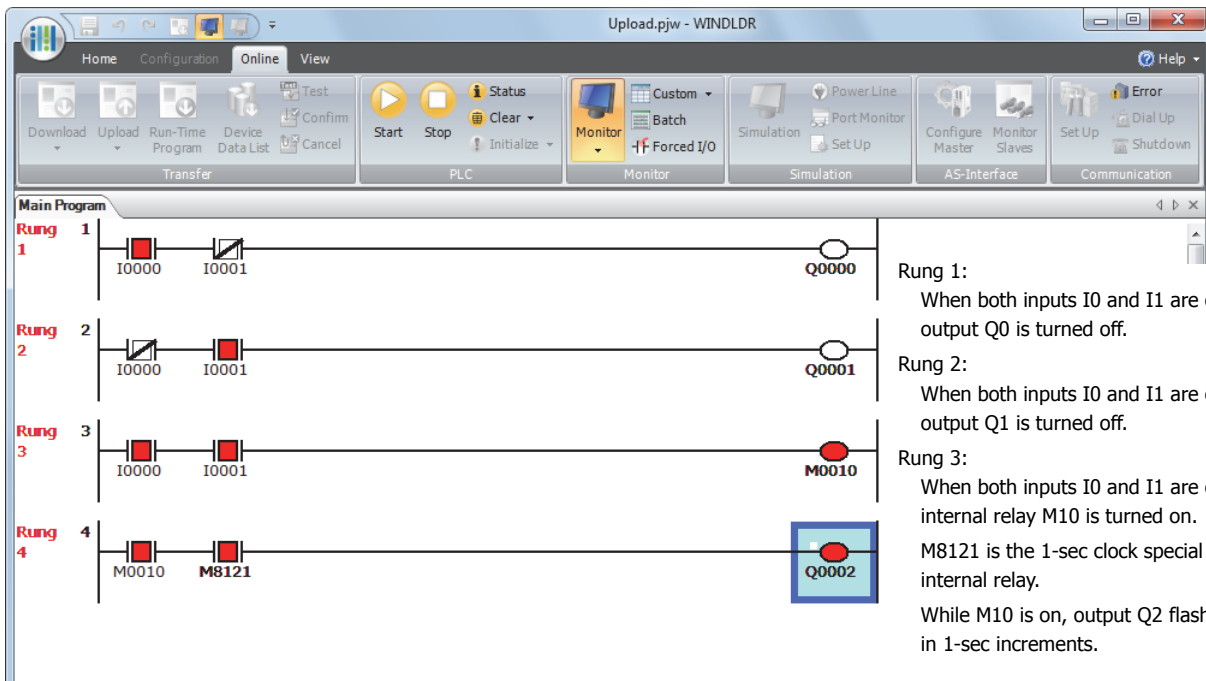

Quit WindLDR

When you have completed monitoring, you can quit WindLDR either directly from the monitor screen or from the editing screen. In both cases, from the WindLDR application button, click **Exit WindLDR**.

2: LADDER PROGRAM MONITORING ON THE SMARTAXIS

Introduction

SmartAXIS Pro and Touch are equipped with an LCD and capable of monitoring the ladder program in the SmartAXIS. This chapter describes how to use the ladder program monitoring.

Notes

- For other SmartAXIS Pro functions, refer to the "SmartAXIS Pro/Lite User's Manual".
- For other SmartAXIS Touch functions, refer to the "SmartAXIS Touch User's Manual".

Applicable SmartAXIS

| FT1A-12 | FT1A-24 | FT1A-40 | FT1A-48 | FT1A-Touch |
|---------|---------|---------|---------|------------|
| X | X | X | X | X |







Basic Operations

LCD and Operation Buttons

SmartAXIS Pro

Five symbols horizontally and two symbols vertically are displayed in the ladder program display screen.

The operation buttons are laid out on SmartAXIS Pro as shown in the diagram on the right.



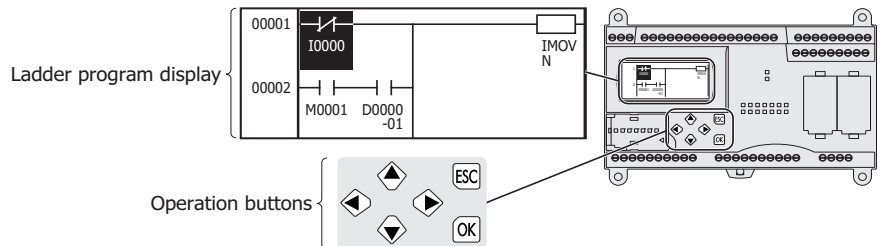



A total of six buttons,  (left),  (up),  (down),  (right),  (ESC), and  (OK), are available to use.



For the SmartAXIS Touch

Five symbols horizontally and two symbols vertically are displayed in the ladder program display screen.

The operation buttons are laid out on the LCD display screen.

A total of six buttons,  (left),  (up),  (down),  (right),  (ESC), and  (OK), are available to use.

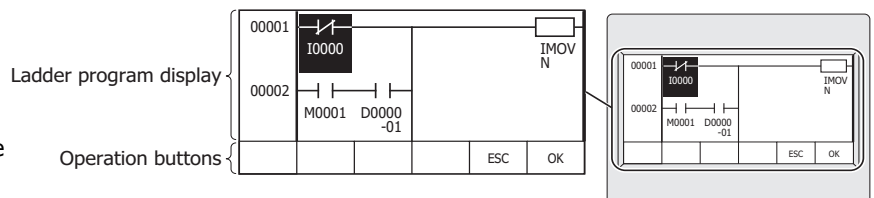

Note: The LCD resolution (number of pixels) differs between the SmartAXIS Pro and the SmartAXIS Touch, but the content of the ladder program display screen is the same, excluding the display area for the SmartAXIS Touch operation buttons. This chapter describes the operations using the LCD display on the SmartAXIS Pro. When using the SmartAXIS Touch, read this manual taking into consideration that the operation button display area is omitted.

Button Operations

The button operations differ when the button is pressed and released and when the button is pressed and held.

| Press/Hold | Operation |
|----------------|--|
| Press | The button is pressed for 0.1 seconds or more and less than 2 seconds and then released. |
| Press and hold | The button is pressed for 2 seconds or more and then released. |

Notes

- This chapter describes the button operations for the ladder program monitoring.
- For details on SmartAXIS Pro button operations, refer to the "SmartAXIS Pro/Lite User's Manual".
- For details on SmartAXIS Touch button operations, refer to the "SmartAXIS Touch User's Manual".

2: LADDER PROGRAM MONITORING ON THE SMARTAXIS

List of Button Operations on the Ladder Program Display Screen

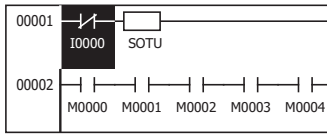

| Button | Press/Hold | Basic operation |
|-------------|----------------|---|
| OK/OK | Press | When the cursor is on a NO contact or a NC contact, this toggles the state of that contact. When the cursor is not on a NO contact or a NC contact, nothing happens. |
| | Press and hold | Displays the details screen (a screen that displays the details of the instruction at the cursor position). |
| ESC/ESC | Press | Ends the ladder program monitoring. |
| | Press and hold | Nothing happens. |
| Up Arrow | Press | Moves the cursor up one line. When the cursor is on the top line of a rung, nothing happens. |
| | Press and hold | Repeats the press operation. |
| Down Arrow | Press | Moves the cursor down one line. When the cursor is at the last line of the ladder program, nothing happens. |
| | Press and hold | Repeats the press operation. |
| Right Arrow | Press | Moves the cursor to the right. When the cursor is at the right edge of a line, nothing happens. |
| | Press and hold | Repeats the press operation. |
| Left Arrow | Press | Moves the cursor to the left. When the cursor is at the left edge of a line, nothing happens. |
| | Press and hold | Repeats the press operation. |

List of Button Operations when an Item is Selected

Details screen

```
OPCODE: MOV (W)
S1 -: D0000 = 1234
D1 R: D0123 = 1234
REP : 03/99
```

| Button | Press/Hold | Basic operation |
|-------------|----------------|---|
| OK/OK | Press | Nothing happens. |
| | Press and hold | |
| ESC/ESC | Press | Returns to the ladder program display screen. |
| | Press and hold | Ends the ladder program monitor. |
| Right Arrow | Press | With the repeat designation ('R' is displayed), this button displays the device with 1 added to the currently displayed device number. This operates until the repeat count displayed in REP matches the repeatable range. If there is no repeat designation ('-' is displayed), nothing happens. |
| | Press and hold | Repeats the press operation. |
| Left Arrow | Press | With the repeat designation ('R' is displayed), this button displays the device with 1 subtracted from the currently displayed device number. This operates until the repeat count displayed in REP is "01". If there is no repeat designation ('-' is displayed), nothing happens. |
| | Press and hold | Repeats the press operation. |
| Up Arrow | Press | If there is a displayed item above the current screen, the screen moves up once. |
| | Press and hold | Repeats the press operation. |
| Down Arrow | Press | If there is a displayed item below the current screen, the screen moves down once. |
| | Press and hold | Repeats the press operation. |

Ladder Program Monitor

This function displays the ladder program on the LCD along with execution states. This enables you to visually understand the states of the ladder program.

Displayed Contents

Display example

Note: The LCD resolution (number of pixels) differs between the SmartAXIS Pro and the SmartAXIS Touch, but the content of the ladder program display screen is the same, excluding the display area for the SmartAXIS Touch operation buttons. This chapter describes the operations using the LCD display on the SmartAXIS Pro. When using the SmartAXIS Touch, read this manual taking into consideration that the operation Button display area is omitted.

Five symbols horizontally and two symbols vertically are displayed in the ladder program display screen. For the symbol of each instruction, see "Instructions Reference" on page 4-1.

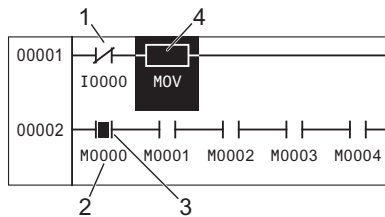

Ladder program display screen

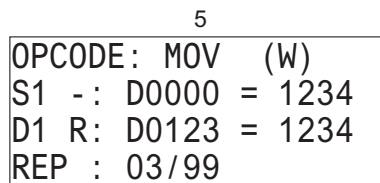

Details screen



Explanation of displayed content

- Shows the cursor. The content at the cursor position is displayed inverted.
- Devices are shown as "device symbol (one character)" + "address (four digits)" (+ "bit position (two digits)").
For devices, see "Device Addresses" on page 3-1.
- If the instruction results (output) is on, it is displayed inverted.
- Instructions except for LOD, LODN, OUT, OUTN, SET, RST, AND, ANDN, OR, and ORN are displayed as  with the instruction name displayed in a maximum of five characters under the box. MCS, MCR, JMP, END, LABEL, LJMP, LCAL, and LRET instructions are displayed in one line on the screen.
- When the  (OK) button is pressed, the details of the instruction at the cursor position are displayed. A maximum of four lines are displayed.
Press the  (ESC) button to return to the original screen.

Details of the following instructions can be displayed in the Details screen: LOD, LODN, OUT, OUTN, SET, RST, AND, ANDN, OR, ORN, TML, TIM, TMH, TMS, TMLO, TIMO, TMHO, TMSO, CNT, CDP, CUD, CNTD, CDPD, CUDD, SFR, SFRN, CC=, CC>=, DC=, DC>= (basic instructions), MOV, MOVN, IMOV, IMOVN, IBMV, IBMVN (move instructions), ADD, SUB, MUL, DIV, INC, DEC, ROOT, SUM (binary arithmetic instructions).

However, programs with a number of columns that exceeds 11 cannot be displayed. Arithmetic operation instructions are all counted as one column. Programs with blocks (circuits) of instructions that start with LOD, LODN, CC=, CC>=, DC=, DC>=, LC<>, LC<, LC>, LC<=, LC>= instructions and end with OUT, OUTN, SET, RST, and arithmetic instructions exceeding four lines cannot be displayed.

Ladder logic program that cannot be monitored example 1

12 or more columns of instructions laid out

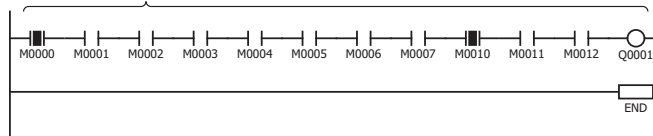

Ladder logic program that cannot be monitored example 2

Blocks (circuits) of instructions that start with LOD, LODN, CC=, CC>=, DC=, DC>=, LC<>, LC<, LC>, LC<=, LC>= instructions and end with OUT, OUTN, SET, RST, and arithmetic instructions that exceed 4 lines

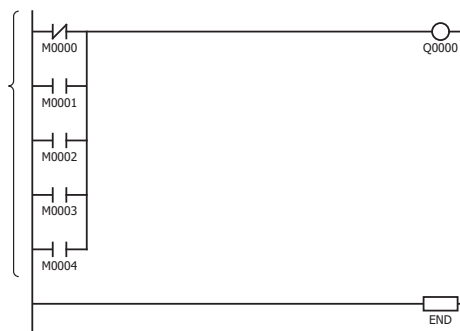

Using the Ladder Program Monitor

This section describes how to monitor the following ladder program.

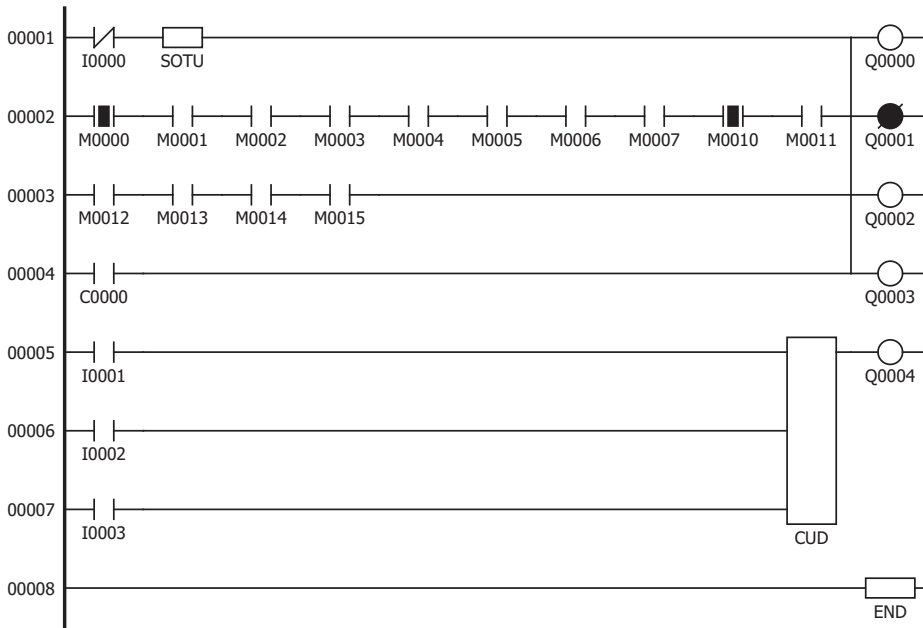

Note: The LCD resolution (number of pixels) differs between the SmartAXIS Pro and the SmartAXIS Touch, but the content of the ladder program display screen is the same, excluding the display area for the SmartAXIS Touch operation buttons. This chapter describes the operations using the LCD display on the SmartAXIS Pro. When using the SmartAXIS Touch, read this manual taking into consideration that the operation button display area is omitted.

Starting the Ladder Program Monitoring

The way to start the ladder program monitor differs between the SmartAXIS Pro and the SmartAXIS Touch.

For the SmartAXIS Pro, see Chapter 6 "HMI Function" - "Monitoring the Program" in the SmartAXIS Pro/Lite User's Manual, and start the ladder program monitoring.

For the SmartAXIS Touch, see Chapter 24 "Monitor Functions" - "2.3 Ladder Program Monitor" - "Ladder Monitor" in the SmartAXIS Touch User's Manual and start the ladder program monitoring.

When the ladder program monitor is started, the ladder line selection screen is displayed. When the ladder line is specified, the ladder program including the specified line is displayed.

Ladder line selection screen

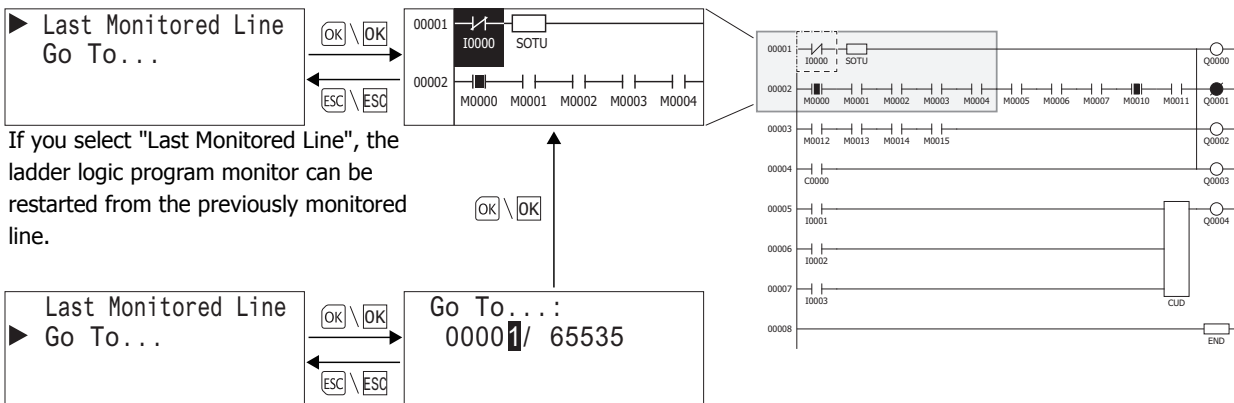

If you select "Last Monitored Line", the ladder logic program monitor can be restarted from the previously monitored line.

If you select "Go To..." and specify a ladder logic program monitor line, the ladder logic program is displayed with the specified line at the beginning.

Notes:

The previously monitored line default setting is the 1st line.

- The previously monitored line is reset to the default setting at the times listed below.
- The SmartAXIS Pro power is turned on again.
- A user program is downloading to the SmartAXIS Pro.

Moving the Cursor

1. Press the  (right) button once.
The cursor moves column to the right.

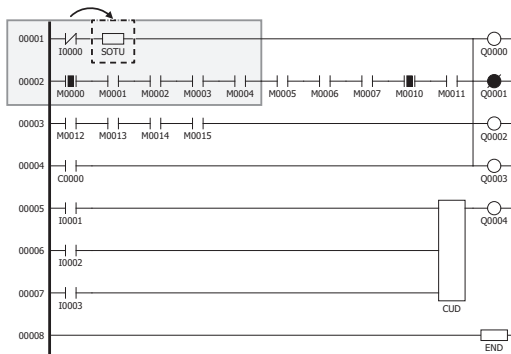
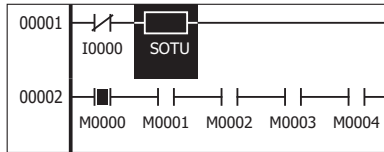

2. Press the  (down) button once.
The cursor moves one line down.

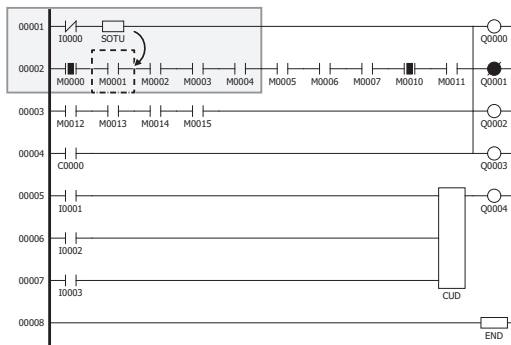
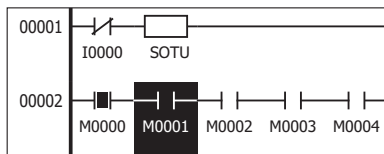

3. Press the  (right) button four times.
The ladder program display screen moves right one instruction.

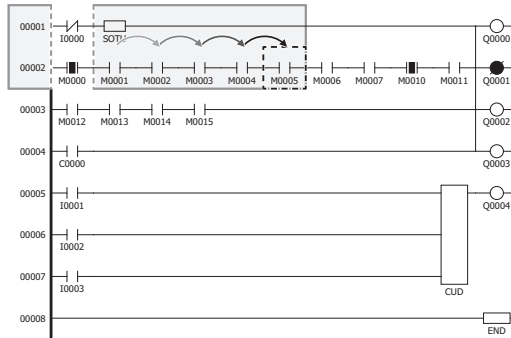
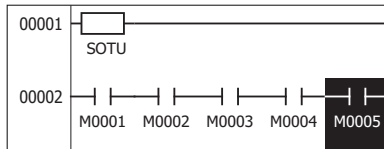

4. Press the  (down) button once.
The ladder program display screen moves down one line.

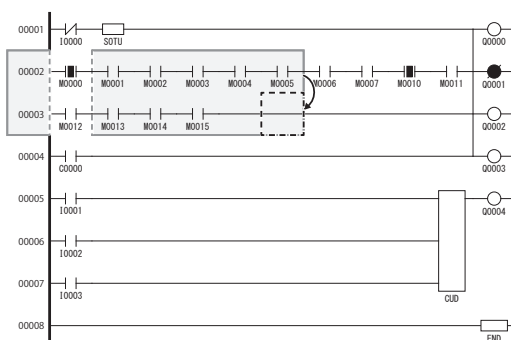
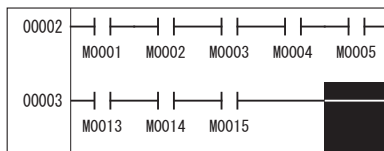

2: LADDER PROGRAM MONITORING ON THE SMARTAXIS

5. Press the  (down) button twice.

The cursor moves to the start of the next rung. The ladder program display screen changes as shown below.

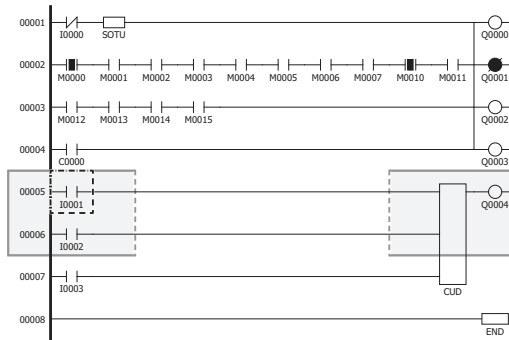
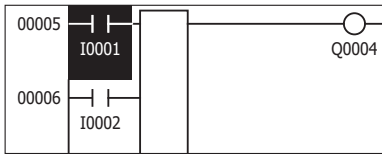

6. Press the  (down) button three times.

The cursor moves to the rung containing the END instruction.

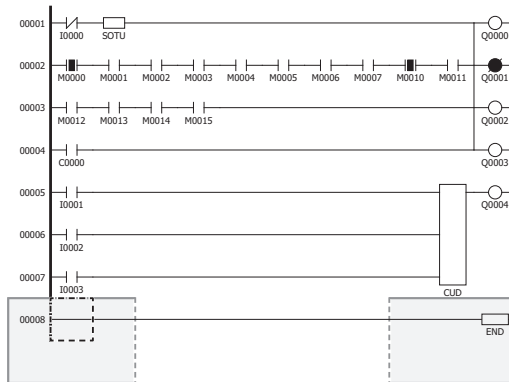

Displaying Detailed Device Information

This section describes the steps to monitor the detailed information of the CUD instruction.

1. In the state of step 5 on the previous page, press the (right) button once.
The cursor moves to the CUD instruction.

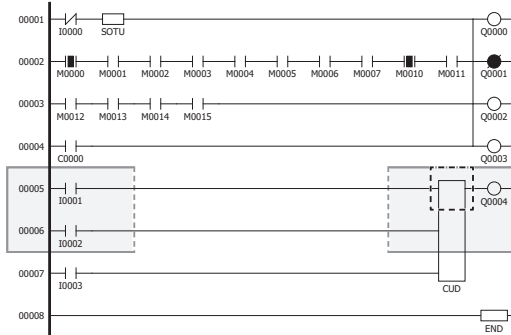
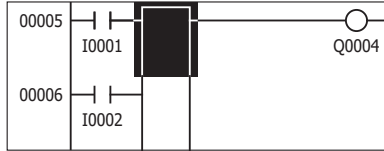

2. With the cursor at the position of the CUD instruction, press the (OK) button.
The details screen is displayed.

```

OPCODE: CUD      (W)
C   : C 000 = ON
PRE : #          =   5
CUR : CC000 =    0
    
```

3. After you check the details, press the (ESC) button.
Returns to the ladder program display screen.

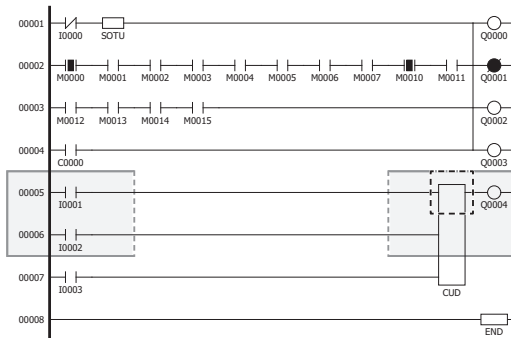
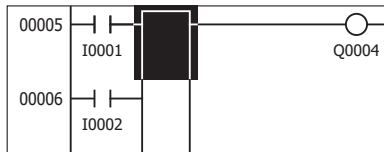

Note: Monitoring ladder program of FT1A Touch using WindLDR

You can monitor ladder programs and change device values of FT1A Touch using WindLDR. There is a limitation when you use bit devices out of the control devices as 16-/32-bit data and change its device values.

When you monitor bit devices, such as internal relays or shift registers, you can monitor values of those bit devices starting from any addresses. However, when you change values of those devices, device addresses must be 16-bit aligned. For example, you can change 16-/32-bit values of internal relays starting with M0000, M0020, or M1180, but values of internal relays starting with M0007, M0037, or M1181 cannot be changed.

When unaligned bit devices are entered in the Custom Monitor dialog box of WindLDR to monitor 16-/32-bit values, monitored values are shown in grayed cell and you cannot change values of those devices.

3: DEVICE ADDRESSES

Introduction

This chapter describes device addresses available for the SmartAXIS Pro/Lite to program basic and advanced instructions. Special internal relays and special data registers are also described. For details on the device addresses of SmartAXIS Touch, see Chapter 27 "Internal Devices" in the SmartAXIS Touch User's Manual.

The SmartAXIS is programmed using devices such as inputs, outputs, remote inputs, remote outputs, internal relays, timers, counters, shift registers, and data registers.

Inputs (I) are relays to receive input signals through the input terminals.

Remote inputs (I) are relays to receive input signals from external devices connected to the remote I/O slaves.

Outputs (Q) are relays to send the processed results of the user program to the output terminals.

Remote outputs (O) are relays to send output signals to external devices connected to the remote I/O slaves.

Internal relays (M) are relays used in the CPU and cannot be output to the output terminals.

Special internal relays (M) are internal relays dedicated to specific functions.

Timers (T) are relays used in the user program, available as 1-sec, 100-ms, 10-ms, and 1-ms timers.

Counters (C) are relays used in the user program, available as adding counters and reversible counters.

Shift registers (R) are registers to shift the data bits according to pulse inputs.

Data registers (D) are registers used to store numerical data.

Special data registers (D) are dedicated to special functions.

Device Addresses

Available I/O numbers depend on the SmartAXIS type.

| Device | FT1A-12 | | FT1A-24 | | FT1A-40 | | FT1A-48 | | FT1A-Touch | |
|--|----------------|--------|--|--------|--|--------|--|--------|--|--------|
| | Device Address | Points | Device Address | Points | Device Address | Points | Device Address | Points | Device Address | Points |
| Input (I)^{*1} | I0 - I7 | 8 | I0 - I7 I10 - I17 | 16 | I0 - I7 I10 - I17 I20 - I27 | 24 | I0 - I7 I10 - I17 I20 - I27 I30 - I35 | 30 | I0 - I7 | 8 |
| Remote Input (I)^{*1} | — | — | I40 - I75 I80 - I115 I120 - I155 | 90 | I40 - I75 I80 - I115 I120 - I155 | 90 | I40 - I75 I80 - I115 I120 - I155 | 90 | I40 - I75 I80 - I115 I120 - I155 | 90 |
| Output (Q)^{*1} | Q0 - Q3 | 4 | Q0 - Q7 | 8 | Q0 - Q7 Q10 - Q17 | 16 | Q0 - Q7 Q10 - Q17 Q20, Q21 | 18 | Q0 - Q3 | 4 |
| Remote Output (Q)^{*1} | — | — | Q40 - Q61 Q80 - Q101 Q120 - Q141 | 54 | Q40 - Q61 Q80 - Q101 Q120 - Q141 | 54 | Q40 - Q61 Q80 - Q101 Q120 - Q141 | 54 | Q40 - Q61 Q80 - Q101 Q120 - Q141 | 54 |
| Internal Relay (M)^{*1} | M0 - M317 | 256 | M0 - M1277 | 1024 | M0 - M1277 | 1024 | M0 - M1277 | 1024 | M0 - M1277 | 1024 |
| Special Internal Relay (M)^{*1} | M8000 - M8177 | 144 | M8000 - M8177 | 144 | M8000 - M8177 | 144 | M8000 - M8177 | 144 | M8000 - M8177 | 144 |
| Shift Register (R) | R0 - R127 | 128 | R0 - R127 | 128 | R0 - R127 | 128 | R0 - R127 | 128 | R0 - R127 | 128 |
| Timer (T) | T0 - T99 | 100 | T0 - T199 | 200 | T0 - T199 | 200 | T0 - T199 | 200 | T0 - T199 | 200 |
| Counter (C) | C0 - C99 | 100 | C0 - C199 | 200 | C0 - C199 | 200 | C0 - C199 | 200 | C0 - C199 | 200 |
| Data Register (D)^{*3} | D0 - D399 | 400 | D0 - D1999 ^{*2} | 2000 | D0 - D1999 ^{*2} | 2000 | D0 - D1999 ^{*2} | 2000 | D0 - D1999 | 2000 |
| Special Data Register (D) | D8000 - D8199 | 200 | D8000 - D8199 | 200 | D8000 - D8199 | 200 | D8000 - D8199 | 200 | D8000 - D8199 | 200 |

Notes:

*1 The least significant digit of input, output, internal relay, and special internal relay device address is an octal number (0 through 7). Upper digits are decimal numbers.

*2 Out of data registers D0 through D1999, D1000 through D1999 cannot be designated as "keep" types. Retained in STOP→RUN, but zeroed out when the power is turned on.

*3 For SmartAXIS Pro/Lite, when you use data register ROM backup, you can initialize the data registers with the values backed up in ROM. For details, see Chapter 5 "Special Functions" – "Data Register ROM Backup" in the SmartAXIS Pro/Lite User's Manual.

3: DEVICE ADDRESSES

Special Internal Relays

Special internal relays M8000 through M8177 are used for controlling the CPU operation and communication and for indicating CPU status. All special internal relays cannot be used as destinations of advanced instructions.

Internal relays M300 through M335 are used to read input device status of the IOREF (I/O refresh) instruction.

Note: Do not change the status of reserved special internal relays, otherwise the SmartAXIS may not operate correctly.

Special Internal Relay Device Addresses

| Device Address | Description | CPU Stopped | Power OFF | Read/Write | |
|-----------------|---|-------------------------|------------|------------|------------|
| M8000 | Start Control | Maintained | Maintained | Read/Write | |
| M8001 | 1-sec Clock Reset | Cleared | Cleared | Write | |
| M8002 | All Outputs OFF | Cleared | Cleared | Write | |
| M8003 | Carry (Cy) or Borrow (Bw) | Cleared | Cleared | Read | |
| M8004 | User Program Execution Error | Cleared | Cleared | Read | |
| M8005 | Remote I/O Slave 1 Communication Error | Operating | Cleared | Read | |
| M8006 | Remote I/O Slave 2 Communication Error | Operating | Cleared | Read | |
| M8007 | Remote I/O Slave 3 Communication Error | Operating | Cleared | Read | |
| M8010 | In Daylight Saving Time Period (System version 1.10 or later) | Operating | Cleared | Read | |
| M8011- M8012 | — Reserved — | — | — | — | |
| M8013 | Calendar/Clock Data Write/Adjust Error Flag | Operating | Cleared | Read | |
| M8014 | Calendar/Clock Data Read Error Flag | Operating | Cleared | Read | |
| M8015 | — Reserved — | — | — | — | |
| M8016 | Calendar Data Write Flag | Operating | Cleared | Write | |
| M8017 | Clock Data Write Flag | Operating | Cleared | Write | |
| M8020 | Calendar/Clock Data Write Flag | Operating | Cleared | Write | |
| M8021 | Clock Data Adjust Flag | Operating | Cleared | Write | |
| M8022 | User Communication Receive Instruction Cancel Flag (Port 2) | Cleared | Cleared | Write | |
| M8023 | User Communication Receive Instruction Cancel Flag (Port 3) | Cleared | Cleared | Write | |
| M8024 | BMOV/WSFT Executing Flag | Maintained | Maintained | Read | |
| M8025 | Maintain Outputs While CPU Stopped | Maintained | Cleared | Read/Write | |
| M8026 | SD Memory Card Status | Maintained | Cleared | Read | |
| M8027 | SD Memory Card Writing Flag | Maintained | Cleared | Read | |
| M8030 | High-speed Counter (Group 1/I0) | Comparison Output Reset | Cleared | Cleared | Read/Write |
| M8031 | | Gate Input | Maintained | Cleared | Read/Write |
| M8032 | | Reset Input | Maintained | Cleared | Read/Write |
| M8033 | | Reset Status | Maintained | Cleared | Read |
| M8034 | | Comparison ON Status | Maintained | Cleared | Read |
| M8035 | | Overflow | Maintained | Cleared | Read |
| M8036 | | Underflow | Maintained | Cleared | Read |
| M8037 | | Count Direction | Maintained | Cleared | Read |
| M8040 | High-speed Counter (Group 2/I2) | Comparison Output Reset | Cleared | Cleared | Read/Write |
| M8041 | | Gate Input | Maintained | Cleared | Read/Write |
| M8042 | | Reset Input | Maintained | Cleared | Read/Write |
| M8043 | | Comparison ON Status | Maintained | Cleared | Read |
| M8044 | Overflow | Maintained | Cleared | Read | |
| M8045 | High-speed Counter (Group 3/I3) | Comparison Output Reset | Cleared | Cleared | Read/Write |
| M8046 | | Gate Input | Maintained | Cleared | Read/Write |
| M8047 | | Reset Input | Maintained | Cleared | Read/Write |
| M8050 | | Reset Status | Maintained | Cleared | Read |
| M8051 | | Comparison ON Status | Maintained | Cleared | Read |
| M8052 | | Overflow | Maintained | Cleared | Read |
| M8053 | | Underflow | Maintained | Cleared | Read |
| M8054 | | Count Direction | Maintained | Cleared | Read |

| Device Address | Description | | CPU Stopped | Power OFF | Read/Write |
|-------------------------|--|---|-------------|------------|------------|
| M8055 | High-speed Counter (Group 4/I5) | Comparison Output Reset | Cleared | Cleared | Read/Write |
| M8056 | | Gate Input | Maintained | Cleared | Read/Write |
| M8057 | | Reset Input | Maintained | Cleared | Read/Write |
| M8060 | | Comparison ON Status | Maintained | Cleared | Read |
| M8061 | | Overflow | Maintained | Cleared | Read |
| M8062- M8067 | — Reserved — | | — | — | — |
| M8070 | Interrupt Input I0 Status | (ON: Allowed, OFF: Prohibited) | Cleared | Cleared | Read |
| M8071 | Interrupt Input I2 Status | | Cleared | Cleared | Read |
| M8072 | Interrupt Input I3 Status | | Cleared | Cleared | Read |
| M8073 | Interrupt Input I5 Status | | Cleared | Cleared | Read |
| M8074 | Interrupt Input I6 Status | | Cleared | Cleared | Read |
| M8075 | Interrupt Input I7 Status | | Cleared | Cleared | Read |
| M8076 | SD Memory Card Access Stop Flag | | Operating | Cleared | Write |
| M8077 | — Reserved — | | — | — | — |
| M8080 | Interrupt Input I0 Edge | (ON: Rising, OFF: Falling) | Cleared | Cleared | Read |
| M8081 | Interrupt Input I2 Edge | | Cleared | Cleared | Read |
| M8082 | Interrupt Input I3 Edge | | Cleared | Cleared | Read |
| M8083 | Interrupt Input I5 Edge | | Cleared | Cleared | Read |
| M8084 | Interrupt Input I6 Edge | | Cleared | Cleared | Read |
| M8085 | Interrupt Input I7 Edge | | Cleared | Cleared | Read |
| M8086 M8087 | — Reserved — | | — | — | — |
| M8090 | Catch Input ON/OFF Status | Group 1/I0 | Maintained | Cleared | Read |
| M8091 | | Group 2/I2 | Maintained | Cleared | Read |
| M8092 | | Group 3/I3 | Maintained | Cleared | Read |
| M8093 | | Group 4/I5 | Maintained | Cleared | Read |
| M8094 | | Group 5/I6 | Maintained | Cleared | Read |
| M8095 | | Group 6/I7 | Maintained | Cleared | Read |
| M8096 M8097 | — Reserved — | | — | — | — |
| M8100 | User Communication | Connection 1 | Cleared | Cleared | Write |
| M8101 | Receive Instruction Cancel Flag | Connection 2 | Cleared | Cleared | Write |
| M8102 | | Connection 3 | Cleared | Cleared | Write |
| M8103- M8107 | — Reserved — | | — | — | — |
| M8110 | Connection Status | Connection 1 (ON: Connected, OFF: Not Connected) | Operating | Cleared | Read |
| M8111 | | Connection 2 (ON: Connected, OFF: Not Connected) | Operating | Cleared | Read |
| M8112 | | Connection 3 (ON: Connected, OFF: Not Connected) | Operating | Cleared | Read |
| M8113- M8117 | — Reserved — | | — | — | — |
| M8120 | Initialize Pulse | | Cleared | Cleared | Read |
| M8121 | 1-sec Clock | | Operating | Cleared | Read |
| M8122 | 100-ms Clock | | Operating | Cleared | Read |
| M8123 | 10-ms Clock | | Operating | Cleared | Read |
| M8124 | Timer/Counter Preset Value Changed | | Maintained | Maintained | Read |
| M8125 | In-operation Output | | Cleared | Cleared | Read |
| M8126 M8127 | — Reserved — | | — | — | — |
| M8130 | Disconnect User Communication Connection | Connection 1 | Maintained | Cleared | Read/Write |
| M8131 | | Connection 2 | Maintained | Cleared | Read/Write |
| M8132 | | Connection 3 | Maintained | Cleared | Read/Write |
| M8133- M8143 | — Reserved — | | — | — | — |

3: DEVICE ADDRESSES

| Device Address | Description | CPU Stopped | Power OFF | Read/Write | |
|-------------------------|---|-------------------------|------------|------------|------------|
| M8144 | Timer Interrupt Status (ON: Allowed, OFF: Prohibited) | Cleared | Cleared | Read | |
| M8145- M8147 | — Reserved — | — | — | — | |
| M8150 | Comparison Result 1 | Maintained | Cleared | Read | |
| M8151 | Comparison Result 2 | Maintained | Cleared | Read | |
| M8152 | Comparison Result 3 | Maintained | Cleared | Read | |
| M8153 | — Reserved — | — | — | — | |
| M8154 | Data Register ROM Backup | Write | Operating | Cleared | Read/Write |
| M8155 | | Read | Operating | Cleared | Read/Write |
| M8156- M8157 | — Reserved — | — | — | — | |
| M8160 | Key Input Status | ESC Key + Up Key | Cleared | Cleared | Read |
| M8161 | | ESC Key + Down Key | Cleared | Cleared | Read |
| M8162 | | ESC Key + Left Key | Cleared | Cleared | Read |
| M8163 | | ESC Key + Right Key | Cleared | Cleared | Read |
| M8164 M8165 | — Reserved — | — | — | — | |
| M8166 | High-speed Counter (Group5/I6) | Comparison Output Reset | Cleared | Cleared | Read/Write |
| M8167 | | Gate Input | Maintained | Cleared | Read/Write |
| M8170 | | Reset Input | Maintained | Cleared | Read/Write |
| M8171 | | Comparison ON Status | Maintained | Cleared | Read |
| M8172 | | Overflow | Maintained | Cleared | Read |
| M8173 | High-speed Counter (Group 6/I7) | Comparison Output Reset | Cleared | Cleared | Read/Write |
| M8174 | | Gate Input | Maintained | Cleared | Read/Write |
| M8175 | | Reset Input | Maintained | Cleared | Read/Write |
| M8176 | | Comparison ON Status | Maintained | Cleared | Read |
| M8177 | | Overflow | Maintained | Cleared | Read |

M8000 Start Control

M8000 is used to control the operation of the CPU. The CPU stops operation when M8000 is turned off while the CPU is running. M8000 can be turned on or off using the WindLDR Online menu. When a stop or reset input is designated, M8000 must remain on to control the CPU operation using the stop or reset input.

M8000 maintains its status when the CPU is powered down. When the data to be maintained during power failure is broken after the CPU has been off for a period longer than the battery backup duration, the CPU restarts operation or not as selected in **Configuration > Run/Stop Control > Run/Stop Selection at Memory Backup Error**. For details on SmartAXIS Pro/Lite start control, see Chapter 4 "Operation Basics" – "Start/Stop Operation" in the SmartAXIS Pro/Lite User's Manual.

M8001 1-sec Clock Reset

While M8001 is on, M8121 (1-sec clock) is turned off.

M8002 All Outputs OFF

When M8002 is turned on, all outputs and remote outputs go off until M8002 is turned off. Self-maintained circuits using outputs also go off and are not restored when M8002 is turned off.

M8003 Carry (Cy) and Borrow (Bw)

When a carry or borrow results from executing an addition or subtraction instruction, M8003 turns on. M8003 is also used for the bit shift and rotate instructions. For the causes of carry (CY) and borrow (BW), see "Carry and Borrow" on page 4-13.

M8004 User Program Execution Error

When an error occurs while executing a user program, M8004 turns on. The cause of the user program execution error can be checked using **Online > Monitor > Monitor**, then **Online > Status > Error Status > Details**.

For a list of Pro/Lite user program execution errors, see Chapter 13 "Troubleshooting" – "User Program Execution Errors" in the SmartAXIS Pro/Lite User's Manual.

M8005 Remote I/O Slave 1 Communication Error

When an error occurs during communication with remote I/O slave 1, M8005 turns on. When the error is cleared, M8005 turns off.

M8006 Remote I/O Slave 2 Communication Error

When an error occurs during communication with remote I/O slave 2, M8006 turns on. When the error is cleared, M8006 turns off.

M8007 Remote I/O Slave 3 Communication Error

When an error occurs during communication with remote I/O slave 3, M8007 turns on. When the error is cleared, M8007 turns off.

M8010 In Daylight Saving Time Period

When the daylight saving time is enabled, M8010 is turned on while in the daylight saving time period. When the daylight saving time is disabled, M8010 is always off.

M8013 Calendar/Clock Data Write/Adjust Error Flag

When an error occurs while calendar/clock data is written or clock data is adjusted, M8013 turns on. If calendar/clock data is written or clock data is adjusted successfully, M8013 turns off.

M8014 Calendar/Clock Data Read Error Flag

When an error occurs while calendar/clock data is read from the internal clock to the special data registers (D8008 to D8014), M8014 turns on. If calendar/clock data is read successfully, M8014 turns off.

M8016 Calendar Data Write Flag

When M8016 is turned on, data in data registers D8015 through D8018 (calendar new data) are set to the internal clock.

M8017 Clock Data Write Flag

When M8017 is turned on, data in data registers D8019 through D8021 (clock new data) are set to the internal clock.

M8020 Calendar/Clock Data Write Flag

When M8020 is turned on, data in data registers D8015 through D8021 (calendar/clock new data) are set to the internal clock.

M8021 Clock Data Adjust Flag

When M8021 is turned on, the clock is adjusted with respect to seconds. If *seconds* are between 0 and 29 for current time, adjustment for *seconds* will be set to 0 and minutes remain the same. If *seconds* are between 30 and 59 for current time, adjustment for *seconds* will be set to 0 and *minutes* are incremented by one.

M8022 User Communication Receive Instruction Cancel Flag (Port 2)

When M8022 is turned on, all RXD2 instructions ready for receiving user communication through port 2 are disabled.

M8023 User Communication Receive Instruction Cancel Flag (Port 3)

When M8023 is turned on, all RXD3 instructions ready for receiving user communication through port 3 are disabled.

M8024 BMOV/WSFT Executing Flag

While the BMOV or WSFT is executed, M8024 turns on. When completed, M8024 turns off. If the CPU is powered down while executing BMOV or WSFT, M8024 remains on when the CPU is powered up again.

M8025 Maintain Outputs While CPU Stopped

Outputs are normally turned off when the CPU is stopped. M8025 is used to maintain the output statuses when the CPU is stopped. When the CPU is stopped with M8025 turned on, the output ON/OFF statuses are maintained. When the CPU restarts, M8025 is turned off automatically.

M8026 SD Memory Card Status

When an SD memory card is inserted into the SmartAXIS, M8026 turns on. When an SD memory card is not inserted, M8026 turns off.

M8027 SD Memory Card Writing Flag

While logging data is written to the SD memory card, M8027 turns on. When writing logging data is finished, M8027 turns off.

M8030-M8061 Special Internal Relays for High-speed Counter

Special internal relays used for the high-speed counter.

For details on the Pro/Lite high-speed counter, see Chapter 5 "Special Functions" – "High-Speed Counter" in the SmartAXIS Pro/Lite User's Manual. For details on the Touch high-speed counter, see Chapter 3 "4.7 High-Speed Counter" in the SmartAXIS Touch User's Manual.

M8070-M8075 Interrupt Input Status

Turns on when the corresponding user interrupt is allowed. When interrupt inputs are disabled, these internal relays are turned off.

M8070=Interrupt input I0 status, M8071=Interrupt input I2 status, M8072=Interrupt input I3 status

M8073=Interrupt input I5 status, M8074=Interrupt input I6 status, M8075=Interrupt input I7 status

M8076 SD Memory Card Access Stop Flag

Access to the SD memory card stops when M8076 is turned from off to on.

M8080-M8085 Interrupt Input Edge (ON: Rising, OFF: Falling)

This flag indicates whether the interrupt input is triggered with a rising edge or falling edge.

M8090-M8095 Catch Input ON/OFF Status

When a rising or falling input edge is detected during a scan, the input statuses of catch inputs Group 1/I0 through Group 6/I7 at the moment are set to M8090 through M8095, respectively, without regard to the scan status. Only one edge is detected in one scan. For the catch input function, see Chapter 5 "Special Functions" - "Catch Input" in the SmartAXIS Pro/Lite User's Manual.

M8100-M8102 User Communication Receive Instruction Cancel Flag

When M8100, M8101, or M8102 is turned on, all ERXD instructions ready for receiving user communication through connection 1, connection 2, or connection 3 are disabled, respectively.

M8110-M8112 Connection Status

When SmartAXIS and a network device are connected via the maintenance communication server, user communication server/client, or Modbus TCP server/client, the connection status turns on. When no network devices are connected, the connection status turns off.

These relays are always off for the 12-I/O type (SmartAXIS without Ethernet port).

M8120 Initialize Pulse

When the CPU starts operation, M8120 turns on for a period of one scan.

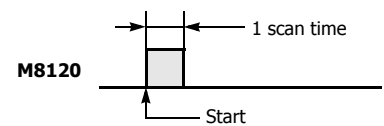
**M8121 1-sec Clock**

While M8001 (1-sec clock reset) is off, M8121 generates clock pulses in 1-sec increments, with a duty ratio of 1:1 (500 ms on and 500 ms off).

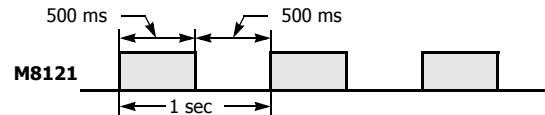
**M8122 100-ms Clock**

M8122 always generates clock pulses in 100-ms increments, whether M8001 is on or off, with a duty ratio of 1:1 (50 ms on and 50 ms off).

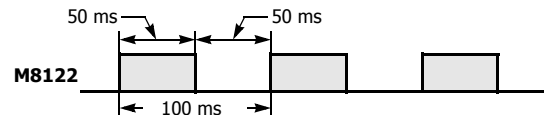
**M8123 10-ms Clock**

M8123 always generates clock pulses in 10-ms increments, whether M8001 is on or off, with a duty ratio of 1:1 (5 ms on and 5 ms off).

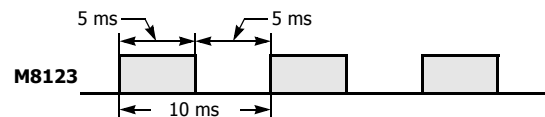
**M8124 Timer/Counter Preset Value Changed**

When timer or counter preset values are changed in the CPU module RAM, M8124 turns on. When a user program is downloaded to the CPU from WindLDR or when the changed timer/counter preset value is cleared, M8124 turns off.

When a timer or counter is designated as a destination of an advanced instruction, the timer/counter preset value is also changed.

M8125 In-operation Output

M8125 remains on while the CPU is running.

M8130-M8132 Disconnect User Communication Connection

When SmartAXIS is connected to a remote host with the user communication client and a special internal relay corresponding to the connection is turned from off to on, the connection is disconnected. Special internal relays M8130 through M8132 are allocated to connections 1 through 3, respectively.

These relays are enabled only when user communication client is used. These relays have no effect for the user communication server. Nothing happens for the 12-I/O type (SmartAXIS without Ethernet port) when these relays are turned on.

M8144 Timer Interrupt Status

When timer interrupt is enabled, M8144 is turned on. When disabled, M8144 is turned off.

M8150 Comparison Result 1

When the CMP= instruction is used, M8150 is turned on when the value of device designated by S1 is greater than that of device designated by S2 ($S1 > S2$). See "Special Internal Relays M8150, M8151, and M8152 in CMP=" on page 7-2.

When the ICMP>= instruction is used, M8150 is turned on when the value of device designated by S2 is greater than that of device designated by S1 ($S2 < S1$). See "Special Internal Relays M8150, M8151, and M8152 in ICMP>=" on page 7-6.

M8151 Comparison Result 2

When the CMP= instruction is used, M8151 is turned on when the value of device designated by S1 is equal to that of device designated by S2 ($S1 = S2$). See "Special Internal Relays M8150, M8151, and M8152 in CMP=" on page 7-2.

When the ICMP>= instruction is used, M8151 is turned on when the value of device designated by S3 is greater than that of device designated by S2 ($S3 > S2$). See "Special Internal Relays M8150, M8151, and M8152 in ICMP>=" on page 7-6.

M8152 Comparison Result 3

When the CMP= instruction is used, M8152 is turned on when the value of device designated by S1 is less than that of device designated by S2 ($S1 < S2$). See "Special Internal Relays M8150, M8151, and M8152 in CMP=" on page 7-2.

When the ICMP>= instruction is used, M8152 is turned on when the value of device designated by S2 is less than that of device designated by S1 and greater than that of device designated by S3 ($S1 > S2 > S3$). See "Special Internal Relays M8150, M8151, and M8152 in ICMP>=" on page 7-6.

M8154 Write Data Register values to ROM

This special internal relay is used for the data register ROM backup. When M8154 is on at the end of scan, the values of all data registers are written to ROM. After writing values, the execution status is stored in D8133 and M8154 turns off. For details, see Chapter 5 "Special Functions" – "Data Register ROM Backup" in the SmartAXIS Pro/Lite User's Manual.

M8155 Read Data Register values from ROM

This special internal relay is used for the data register ROM backup. When M8155 turns on at the end of scan, the values in the corresponding ROM are read and stored in the data registers specified by D8184 (start address to read) and D8185 (number of

registers to read). After reading values, the execution status is stored in D8133 and M8155 turns off. For details, see Chapter 5 "Special Functions" – "Data Register ROM Backup" in the SmartAXIS Pro/Lite User's Manual.

M8160-M8163 Button Input Status

When the ESC and direction buttons on the SmartAXIS Pro are simultaneously pressed, the corresponding special internal relays M8160 through M8163 turn on. When no buttons are pressed, M8160 through M8163 turn off.

M8166-M8177 Special Internal Relays for High-speed Counter

Special internal relays used for the high-speed counter.

For details on the Pro/Lite high-speed counter, see Chapter 5 "Special Functions" – "High-Speed Counter" in the SmartAXIS Pro/Lite User's Manual. For details on the Touch high-speed counter, see Chapter 3 "4.7 High-Speed Counter" in the SmartAXIS Touch User's Manual.

Special Data Registers

Note: Do not change the data in any of the reserved special data registers, otherwise the SmartAXIS may not operate correctly.

Special Data Register Device Addresses

| Device Address | Description | Updated | See Page |
|--------------------|--|--|--|
| D8000 | Quantity of Inputs | When I/O initialized | 3-12 |
| D8001 | Quantity of Outputs | When I/O initialized | 3-12 |
| D8002 | SmartAXIS Type Information | Power-up | 3-12 |
| D8003 | Memory Cartridge Information | Power-up | 3-12 |
| D8004 | — Reserved — | — | — |
| D8005 | General Error Code | When error occurred | 3-12 |
| D8006 | User Program Execution Error Code | When error occurred | 3-12 |
| D8007 | — Reserved — | — | — |
| D8008 | Calendar/Clock Current Data (Read only) | Year | Every 500 ms |
| D8009 | | Month | Every 500 ms |
| D8010 | | Day | Every 500 ms |
| D8011 | | Day of Week | Every 500 ms |
| D8012 | | Hour | Every 500 ms |
| D8013 | | Minute | Every 500 ms |
| D8014 | | Second | Every 500 ms |
| D8015 | | Calendar/Clock New Data (Write only) | Year |
| D8016 | Month | | — |
| D8017 | Day | | — |
| D8018 | Day of Week | | — |
| D8019 | Hour | | — |
| D8020 | Minute | | — |
| D8021 | Second | | — |
| D8022 | Scan Time Data | | Constant Scan Time Preset Value (1 to 1,000 ms) |
| D8023 | | Scan Time Current Value (ms) | Every scan |
| D8024 | | Scan Time Maximum Value (ms) | At occurrence |
| D8025 | | Scan Time Minimum Value (ms) | At occurrence |
| D8026 | Communication Mode Information (Port 2 and Port 3) | Every scan | 3-13 |
| D8027 | Port 2 Slave Number | Every scan | 3-13 |
| D8028 | Port 3 Slave Number | Every scan | 3-13 |
| D8029 | System Software Version | Power-up | 3-13 |
| D8030 | Communication Adapter Information | Power-up | 3-13 |
| D8031 | Optional Cartridge Information | Power-up | 3-13 |
| D8032 | Interrupt Input Jump Destination Label No. (I0) | — | 3-14 |
| D8033 | Interrupt Input Jump Destination Label No. (I2) | — | 3-14 |
| D8034 | Interrupt Input Jump Destination Label No. (I3) | — | 3-14 |
| D8035 | Interrupt Input Jump Destination Label No. (I5) | — | 3-14 |
| D8036 | Timer Interrupt Jump Destination Label No. | — | 3-14 |
| D8037 | Interrupt Input Jump Destination Label No. (I6) | — | 3-14 |
| D8038 | Interrupt Input Jump Destination Label No. (I7) | — | 3-14 |
| D8039 | SD Memory Card Capacity (Megabytes) | Every 1 sec | 3-14 |
| D8040 | Analog Input Value (AI0) | Every scan | 3-14 |
| D8041 | Analog Input Value (AI1) | Every scan | 3-14 |
| D8042 | Analog Input Value (AI2) | Every scan | 3-14 |
| D8043 | Analog Input Value (AI3) | Every scan | 3-14 |
| D8044 | Analog Input Value (AI4) | Every scan | 3-14 |
| D8045 | Analog Input Value (AI5) | Every scan | 3-14 |
| D8046 | Analog Input Value (AI6) | Every scan | 3-14 |
| D8047 | Analog Input Value (AI7) | Every scan | 3-14 |
| D8048-D8049 | — Reserved — | — | — |

3: DEVICE ADDRESSES

| Device Address | Description | | Updated | See Page | |
|--------------------|---|-----------|--|------------|------|
| D8050 | High-speed Counter (Group 1/I0) | High Word | Current Value / Frequency Measurement Value (I0) | Every scan | 3-14 |
| D8051 | | Low Word | | | |
| D8052 | | High Word | Preset Value | — | 3-14 |
| D8053 | | Low Word | | | |
| D8054 | | High Word | Reset Value | — | 3-14 |
| D8055 | | Low Word | | | |
| D8056 | High-speed Counter (Group 2/I2) | High Word | Current Value / Frequency Measurement Value (I2) | Every scan | 3-14 |
| D8057 | | Low Word | | | |
| D8058 | | High Word | Preset Value | — | 3-14 |
| D8059 | | Low Word | | | |
| D8060 | | High Word | Reset Value | — | 3-14 |
| D8061 | | Low Word | | | |
| D8062 | High-speed Counter (Group 3/I3) | High Word | Current Value / Frequency Measurement Value (I3) | Every scan | 3-14 |
| D8063 | | Low Word | | | |
| D8064 | | High Word | Preset Value | — | 3-14 |
| D8065 | | Low Word | | | |
| D8066 | | High Word | Reset Value | — | 3-14 |
| D8067 | | Low Word | | | |
| D8068 | High-speed Counter (Group 4/I5) | High Word | Current Value / Frequency Measurement Value (I5) | Every scan | 3-14 |
| D8069 | | Low Word | | | |
| D8070 | | High Word | Preset Value | — | 3-14 |
| D8071 | | Low Word | | | |
| D8072 | | High Word | Reset Value | — | 3-14 |
| D8073 | | Low Word | | | |
| D8074 | Backlight ON Time | | Every scan | 3-14 | |
| D8075-D8076 | — Reserved — | | — | — | |
| D8077 | Out of Analog Input Range Status | | — | 3-14 | |
| D8078 | MAC Address (Read only) | | Every 1 sec | 3-14 | |
| D8079 | | | | | |
| D8080 | | | | | |
| D8081 | | | | | |
| D8082 | | | | | |
| D8083 | | | | | |
| D8084 | IP Address (Current Data) Read only | | Every 1 sec | 3-15 | |
| D8085 | | | | | |
| D8086 | | | | | |
| D8087 | Subnet Mask (Current Data) Read only | | Every 1 sec | 3-15 | |
| D8088 | | | | | |
| D8089 | | | | | |
| D8090 | | | | | |
| D8091 | Default Gateway (Current Data) Read only | | Every 1 sec | 3-15 | |
| D8092 | | | | | |
| D8093 | | | | | |
| D8094 | | | | | |
| D8095 | | | | | |
| D8096-D8103 | — Reserved — | | — | — | |
| D8104 | RS232C Control Signal Status (Ports 2 and 3) | | Every scan | 3-15 | |
| D8105 | RS232C DSR Input Control Signal Option (Ports 2 and 3) | | When sending/ receiving data | 3-15 | |
| D8106 | RS232C DTR Output Control Signal Option (Ports 2 and 3) | | When sending/ receiving data | 3-15 | |
| D8107-D8109 | — Reserved — | | — | — | |
| D8110 | Connection 1 Connected IP Address | | Every 1 sec | 3-15 | |
| D8111 | | | | | |
| D8112 | | | | | |
| D8113 | | | | | |

| Device Address | Description | | Updated | See Page | |
|--------------------|------------------------------------|----------------------------|--|---------------------|---------------------|
| D8114 | Connection 2 Connected IP Address | | Every 1 sec | 3-15 | |
| D8115 | | | | | |
| D8116 | | | | | |
| D8117 | | | | | |
| D8118 | Connection 3 Connected IP Address | | Every 1 sec | 3-15 | |
| D8119 | | | | | |
| D8120 | | | | | |
| D8121 | | | | | |
| D8122-D8129 | — Reserved — | | — | — | |
| D8130 | Connection 1 Connected Port Number | | Every 1 sec | 3-16 | |
| D8131 | Connection 2 Connected Port Number | | Every 1 sec | 3-16 | |
| D8132 | Connection 3 Connected Port Number | | Every 1 sec | 3-16 | |
| D8133 | Data Register ROM Backup | Execution Status | When executing data register ROM backup read and write | 3-16 | |
| D8134 | High-speed Counter (Group 5/I6) | High Word | Current Value / Frequency Measurement Value (I6) | Every scan | 3-14 |
| D8135 | | Low Word | | | |
| D8136 | | High Word | Preset Value | — | 3-14 |
| D8137 | | Low Word | | | |
| D8138 | | High Word | Reset Value | — | 3-14 |
| D8139 | | Low Word | | | |
| D8140 | High-speed Counter (Group 6/I7) | High Word | Current Value / Frequency Measurement Value (I7) | Every scan | 3-14 |
| D8141 | | Low Word | | | |
| D8142 | | High Word | Preset Value | — | 3-14 |
| D8143 | | Low Word | | | |
| D8144 | | High Word | Reset Value | — | 3-14 |
| D8145 | | Low Word | | | |
| D8146 | — Reserved — | | — | — | |
| D8147 | — Reserved — | | — | — | |
| D8148 | Remote I/O Slave 1 | Communication Error Status | | When error occurred | 3-16 |
| D8149 | | Analog Input (AI10) | | Every scan | 3-16 |
| D8150 | | Analog Input (AI11) | | Every scan | 3-16 |
| D8151 | | Analog Input (AI12) | | Every scan | 3-16 |
| D8152 | | Analog Input (AI13) | | Every scan | 3-16 |
| D8153 | | Analog Input (AI14) | | Every scan | 3-16 |
| D8154 | | Analog Input (AI15) | | Every scan | 3-16 |
| D8155 | | Analog Input (AI16) | | Every scan | 3-16 |
| D8156 | | Analog Input (AI17) | | Every scan | 3-16 |
| D8157 | | Remote I/O Slave 2 | Communication Error Status | | When error occurred |
| D8158 | Analog Input (AI20) | | Every scan | 3-16 | |
| D8159 | Analog Input (AI21) | | Every scan | 3-16 | |
| D8160 | Analog Input (AI22) | | Every scan | 3-16 | |
| D8161 | Analog Input (AI23) | | Every scan | 3-16 | |
| D8162 | Analog Input (AI24) | | Every scan | 3-16 | |
| D8163 | Analog Input (AI25) | | Every scan | 3-16 | |
| D8164 | Analog Input (AI26) | | Every scan | 3-16 | |
| D8165 | Analog Input (AI27) | | Every scan | 3-16 | |
| D8166 | Remote I/O Slave 3 | | Communication Error Status | | When error occurred |
| D8167 | | Analog Input (AI30) | | Every scan | 3-16 |
| D8168 | | Analog Input (AI31) | | Every scan | 3-16 |
| D8169 | | Analog Input (AI32) | | Every scan | 3-16 |
| D8170 | | Analog Input (AI33) | | Every scan | 3-16 |
| D8171 | | Analog Input (AI34) | | Every scan | 3-16 |
| D8172 | | Analog Input (AI35) | | Every scan | 3-16 |
| D8173 | | Analog Input (AI36) | | Every scan | 3-16 |
| D8174 | | Analog Input (AI37) | | Every scan | 3-16 |

3: DEVICE ADDRESSES

| Device Address | Description | | Updated | See Page |
|----------------|---------------|-----------------------------|---------|----------|
| D8175-D8183 | — Reserved — | | — | — |
| D8184 | Data Register | Start Address to Read | — | 3-16 |
| D8185 | ROM Backup | Number of Registers to Read | — | 3-16 |
| D8186-D8199 | — Reserved — | | — | — |

D8000 Quantity of Inputs

The total of input points provided on the SmartAXIS is stored to D8000.

D8001 Quantity of Outputs

The total of output points provided on the SmartAXIS is stored to D8001.

D8002 SmartAXIS Type Information

Information about the SmartAXIS type is stored to D8002.

- 0: SmartAXIS Pro/Lite 12-I/O type
- 1: SmartAXIS Pro/Lite 24-I/O type
- 2: SmartAXIS Pro/Lite 40-I/O type
- 3: SmartAXIS Pro/Lite 48-I/O type
- 4: SmartAXIS Touch

D8003 Memory Cartridge Information

When an optional memory cartridge is installed on the SmartAXIS cartridge connector, information about the user program stored on the memory cartridge is stored to D8003.

- 0: SmartAXIS Pro/Lite 12-I/O type
- 1: SmartAXIS Pro/Lite 24-I/O type
- 2: SmartAXIS Pro/Lite 40-I/O type
- 3: SmartAXIS Pro/Lite 48-I/O type
- 255: The memory cartridge does not store any user program.

D8005 General Error Code

SmartAXIS general error information is stored to D8005. When a general error occurs, the bit corresponding to the error occurred turns on.

The general error and user program execution error can be cleared by writing "1" to the most significant bit of D8005 using a user program.

For details on Pro/Lite general error codes, see Chapter 13 "Troubleshooting" in the SmartAXIS Pro/Lite User's Manual. For details on Touch general error codes, see Chapter 30 "Troubleshooting" - "3 Troubleshooting" in the SmartAXIS Touch User's Manual.

D8006 User Program Execution Error Code

SmartAXIS user program execution error information is stored to D8006. When a user program execution error occurs, the error code corresponding to the error occurred is stored to D8006.

For details on Pro/Lite user program execution error codes, see Chapter 13 "Troubleshooting" in the SmartAXIS Pro/Lite User's Manual. For details on Touch user program execution error codes, see Chapter 30 "Troubleshooting" - "3 Troubleshooting" in the SmartAXIS Touch User's Manual.

D8008-D8021 Calendar/Clock Data

D8008 through D8021 are used for reading calendar/clock data from the internal clock and for writing calendar/clock data to the internal clock.

D8022-D8025 Scan Time Data

D8022 through D8025 are special data registers for checking the scan time and configuring the constant scan time.

For details on the SmartAXIS Pro/Lite scan time, see Chapter 5 "Special Functions" – "Constant Scan Time" in the SmartAXIS Pro/Lite User's Manual.

D8026 Communication Mode Information (Port 2 and Port 3)

Communication mode information of port 2 and port 3 is stored to D8026.

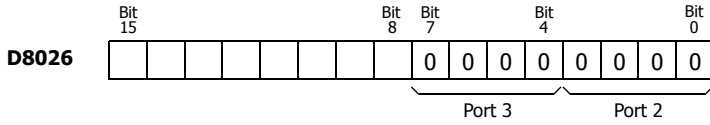

- 0: Maintenance Communication
- 1: User Communication
- 2: Modbus RTU Master
- 3: Modbus RTU Slave

D8027-D8028 Slave Number

The slave number is stored to D8027 and D8028 when the communication mode for port 2 and 3 is maintenance communication or Modbus RTU slave.

The slave number can be specified with either a constant or a data register in the function area settings. When data register is specified, the slave number can be changed by storing the slave number in D8027 and D8028.

D8027: Port 2 Slave Number

D8028: Port 3 Slave Number

For SmartAXIS Pro/Lite maintenance communication, see Chapter 9 "Maintenance Communication" - "Maintenance Communication via Serial Communication" in the SmartAXIS Pro/Lite User's Manual. For Modbus RTU slaves, see Chapter 11 "Modbus Communication" - "Modbus Communication via RS-232C/RS-485" in the SmartAXIS Pro/Lite User's Manual. For SmartAXIS Touch maintenance communication and Modbus RTU slaves, see Chapter 13 "Troubleshooting" - "Reading Error Data" in the SmartAXIS Pro/Lite User's Manual.

D8029 System Software Version

The PLC system software version number is stored to D8029. This value is indicated in the PLC status dialog box called from the WindLDR menu bar. Select **Online > Monitor > Monitor**, then select **Online > Status**. See Chapter 13 "Troubleshooting" - "Reading Error Data" in the SmartAXIS Pro/Lite User's Manual.

D8030 Communication Adapter Information

Information about the communication adapters installed on the port 2 and port 3 connectors is stored to D8030.

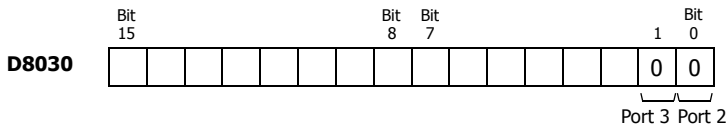

- 0: RS232C communication adapter is installed
- 1: RS485 communication adapter is installed or no communication adapter is installed

D8031 Optional Cartridge Information

Information about the optional cartridge installed on the SmartAXIS is stored to D8031.

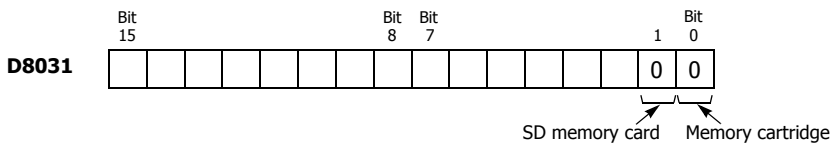

- 0: No optional cartridge is installed
- 1: Memory cartridge is installed
- 2: SD memory card is installed
- 3: Memory cartridge and SD memory card are installed

D8032-D8035, D8037, D8038 Interrupt Input Jump Destination Label No.

Jump destination label numbers for interrupt inputs are stored in these special data registers. To use interrupt inputs, store the label number that corresponds to the special data register allocated to the interrupt input.

D8032=I0, D8033=I2, D8034=I3, D8035=I5, D8037=I6, D8038=I7

For details on SmartAXIS Pro/Lite interrupt inputs, see Chapter 5 "Special Functions" – "Interrupt Inputs" in the SmartAXIS Pro/Lite User's Manual. For details on SmartAXIS Touch interrupt inputs, see Chapter 3 "Project" – "4 Special Functions" – "Interrupt Input" in the SmartAXIS Touch User's Manual.

D8036 Timer Interrupt Jump Destination Label No.

The jump destination label number when the timer interrupt occurs is stored in D8036. To use the timer interrupt, store the corresponding label number.

For details on the SmartAXIS Pro/Lite timer interrupt, see Chapter 5 "Special Functions" – "Timer Interrupt" in the SmartAXIS Pro/Lite User's Manual. For details on the SmartAXIS Touch timer interrupt, see Chapter 3 "Project" – "4 Special Functions" – "Timer Interrupt" in the SmartAXIS Touch User's Manual.

D8039 SD Memory Card Capacity

The capacity of the inserted SD or SDHC (maximum size 32 GB) memory card in megabytes is stored to D8039.

D8040-D8047 Analog Input Value

The analog input values (0 to 10 VDC) to the analog input terminals are converted to digital values (0 to 1000) and stored to the corresponding special data registers.

D8040=AI0, D8041=AI1, D8042=AI2, D8043=AI3, D8044=AI4, D8045=AI5, D8046=AI6, D8047=AI7

D8050-D8073, D8134-D8145 High-speed Counter and Frequency Measurement

These special data registers are used with the high-speed counter function and the frequency measurement function.

For details on the SmartAXIS Pro/Lite high-speed counter, see Chapter 5 "Special Functions" – "High-Speed Counter" in the SmartAXIS Pro/Lite User's Manual. For details on the frequency measurement, see Chapter 5 "Special Functions" – "Frequency Measurement" in the SmartAXIS Pro/Lite User's Manual.

For details on the SmartAXIS Touch high-speed counter, see Chapter 3 "4.7 High-Speed Counter" in the SmartAXIS Touch User's Manual. For details on the frequency measurement, see Chapter 3 "4.10 Frequency Measurement" in the SmartAXIS Touch User's Manual.

D8074 Backlight ON Time

The backlight ON time is stored. The backlight ON time can be configured by changing the value in D8074 between 1 to 65535 seconds. When D8074 is 0, the backlight is always ON. The backlight ON time can also be changed with the HMI function. For details, see Chapter 5 "Special Functions" - "Changing Backlight ON Time" in the SmartAXIS Touch User's Manual.

D8077 Out of Analog Input Range Status

When an analog input value is 11V or higher, the corresponding D8077 bit turns on. When an analog input value is lower than 11V, the corresponding D8077 bit turns off.

The assignment of each analog input is as follows.

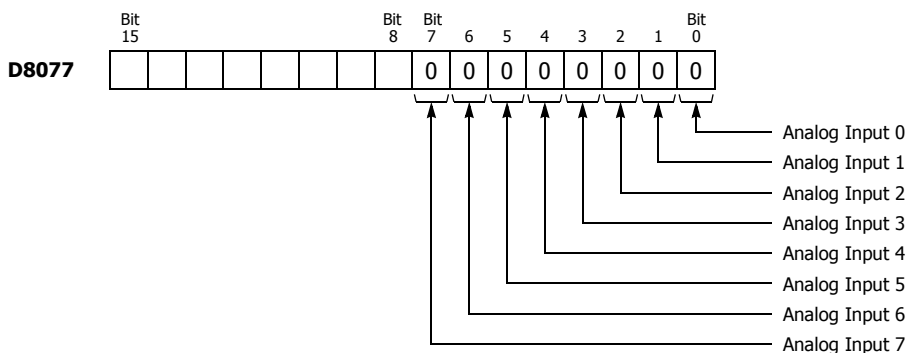

D8078-D8083 MAC Address (Read only)

MAC address of the SmartAXIS is stored to the special data registers in hexadecimal as shown below.

Example) MAC address: AA-BB-CC-DD-EE-FF

D8078=AAh, D8079=BBh, D8080=CCh, D8081=DDh, D8082=EEh, D8083=FFh

D8084-D8087 IP Address (Current Data) Read only

IP address of the SmartAXIS is stored to the special data registers as shown below.

Example) IP address: aaa.bbb.ccc.ddd

D8084=aaa, D8085=bbb, D8086=ccc, D8087=ddd

D8088-D8091 Subnet Mask (Current Data) Read only

Subnet mask of the SmartAXIS is stored to the special data registers as shown below.

Example) Subnet mask: aaa.bbb.ccc.ddd

D8088=aaa, D8089=bbb, D8090=ccc, D8091=ddd

D8092-D8095 Default Gateway (Current Data) Read only

Default gateway of the SmartAXIS is stored to the special data registers as shown below.

Example) Default gateway: aaa.bbb.ccc.ddd

D8092=aaa, D8093=bbb, D8094=ccc, D8095=ddd

D8104 RS232C Control Signal Status (Port 2 and Port 3)

RS232C control signal status of port 2 and port 3 is stored to D8104.

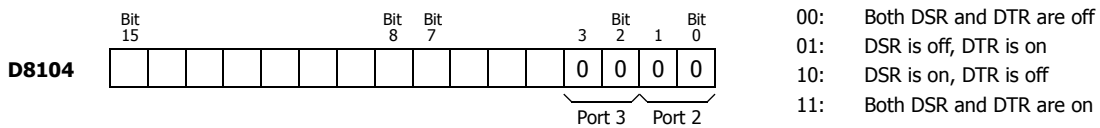

D8105 RS232C DSR Input Control Signal Option (Port 2 and Port 3)

Special data register D8105 is used to control data flow between the SmartAXIS RS232C port 2 and port 3 and the remote terminal depending on the DSR (data set ready) signal sent from the remote terminal.

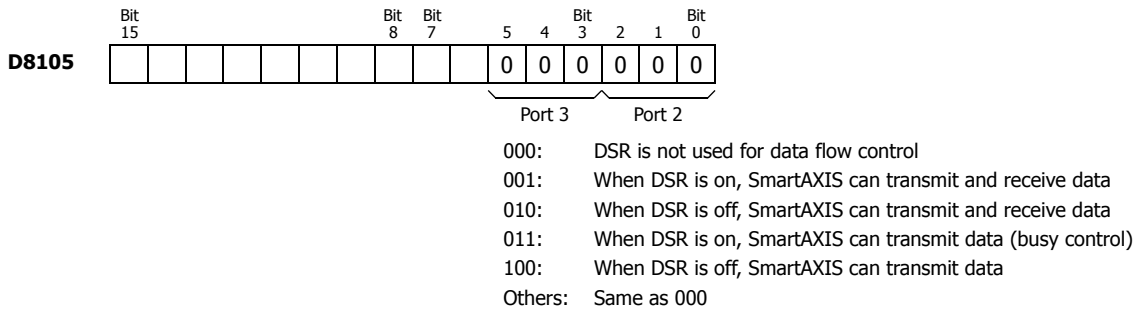

D8106 RS232C DTR Output Control Signal Option (Port 2 and Port 3)

Special data register D8106 is used to control the DTR (data terminal ready) signal to indicate the SmartAXIS operating status or transmitting/receiving status.

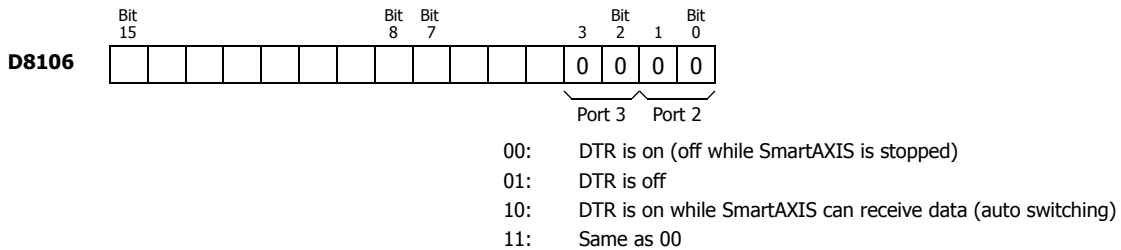

D8110-D8121 Connection (1 through 3) Connected IP Address

The IP address of the remote host accessing the connection 1 through 3 is stored in special data registers.

Example) Connection 1 Connected IP Address: aaa.bbb.ccc.ddd

D8110=aaa, D8111=bbb, D8112=ccc, D8113=ddd

3: DEVICE ADDRESSES

D8130-D8132 Connection Connected Port Number

When connections are established with other network devices, the port numbers of the connected network devices are stored in these special data registers.

D8130 : Connection 1 Connected Port Number

D8131 : Connection 2 Connected Port Number

D8132 : Connection 3 Connected Port Number

D8133 Data Register ROM Backup Execution Status

This special data register is used for the data register ROM backup. Stores the execution status for writing and reading.

1: Processing

2: Normal termination

3: Cannot access ROM

4: Invalid values are stored in D8184 (starting address to read) and D8185 (number of registers to read)

5: Valid data could not be read from ROM

For details, see Chapter 5 "Special Functions" – "Data Register ROM Backup" in the SmartAXIS Pro/Lite User's Manual.

D8148, D8157, D8166 Remote I/O Communication Error Status

When a communication error occurs between the remote I/O communication slave and master, the details of the communication error are stored in these special data registers.

D8148 : Remote I/O Slave 1 Communication Error Status

D8157 : Remote I/O Slave 2 Communication Error Status

D8166 : Remote I/O Slave 3 Communication Error Status

D8149-D8156, D8158-D8165, D8167-D8174 Remote I/O Analog Input Values

The analog input values (0 to 10 VDC) to the remote I/O analog inputs are converted to digital values (0 to 1000) and stored in the special data registers allocated to each remote I/O slave.

- D8149=AI10, D8150=AI11, D8151=AI12, D8152=AI13, D8153=AI14, D8154=AI15, D8155=AI16, D8156=AI17
- D8158=AI20, D8159=AI21, D8160=AI22, D8161=AI23, D8162=AI24, D8163=AI25, D8164=AI26, D8165=AI27
- D8167=AI30, D8168=AI31, D8169=AI32, D8170=AI33, D8171=AI34, D8172=AI35, D8173=AI36, D8174=AI37

D8184 Data Register ROM Backup Start Address to Read

This special data register is used for the data register ROM backup and stores the start address of the data registers to read. For details, see Chapter 5 "Special Functions" – "Data Register ROM Backup" in the SmartAXIS Pro/Lite User's Manual.

D8185 Data Register ROM Backup Number of Registers to Read

This special data register is used for the data register ROM backup and stores the number of data registers to read. For details, see Chapter 5 "Special Functions" – "Data Register ROM Backup" in the SmartAXIS Pro/Lite User's Manual.

4: INSTRUCTIONS REFERENCE

Introduction

SmartAXIS instructions are divided into Basic Instructions, which perform sequencing, and Advanced Instructions, which perform moves, comparisons, Boolean computations, binary arithmetic operations, bit shifts, and other operations.

Basic Instruction List

| Symbol | Name | Function | See Page |
|---------|--|--|----------|
| AND | And | Series connection of NO contact | 5-4 |
| AND LOD | And Load | Series connection of circuit blocks | 5-5 |
| ANDN | And Not | Series connection of NC contact | 5-4 |
| BPP | Bit Pop | Restores the result of bit logical operation which was saved temporarily | 5-6 |
| BPS | Bit Push | Saves the result of bit logical operation temporarily | 5-6 |
| BRD | Bit Read | Reads the result of bit logical operation which was saved temporarily | 5-6 |
| CC= | Counter Comparison (=) | Equal to comparison of counter current value | 5-18 |
| CC>= | Counter Comparison (>=) | Greater than or equal to comparison of counter current value | 5-18 |
| CDP | Dual Pulse Reversible Counter | Dual pulse reversible counter (0 to 65,535) | 5-11 |
| CDPD | Double-word Dual Pulse Reversible Counter | Double-word dual pulse reversible counter (0 to 4,294,967,295) | 5-14 |
| CNT | Adding Counter | Adding counter (0 to 65,535) | 5-11 |
| CNTD | Double-word Adding Counter | Double-word adding counter (0 to 4,294,967,295) | 5-14 |
| CUD | Up/Down Selection Reversible Counter | Up/down selection reversible counter (0 to 65,535) | 5-11 |
| CUDD | Double-word Up/Down Selection Reversible Counter | Double-word up/down selection reversible counter (0 to 4,294,967,295) | 5-14 |
| DC= | Data Register Comparison (=) | Equal to comparison of data register value | 5-20 |
| DC>= | Data Register Comparison (>=) | Greater than or equal to comparison of data register value | 5-20 |
| END | End | Ends a program | 5-30 |
| JEND | Jump End | Ends a jump instruction | 5-29 |
| JMP | Jump | Jumps a designated program area | 5-29 |
| LOD | Load | Stores intermediate results and reads contact status | 5-1 |
| LODN | Load Not | Stores intermediate results and reads inverted contact status | 5-1 |
| MCR | Master Control Reset | Ends a master control | 5-27 |
| MCS | Master Control Set | Starts a master control | 5-27 |
| OR | Or | Parallel connection of NO contact | 5-4 |
| OR LOD | Or Load | Parallel connection of circuit blocks | 5-5 |
| ORN | Or Not | Parallel connection of NC contact | 5-4 |
| OUT | Output | Outputs the result of bit logical operation | 5-1 |
| OUTN | Output Not | Outputs the inverted result of bit logical operation | 5-1 |
| RST | Reset | Resets output, internal relay, or shift register bit | 5-3 |
| SET | Set | Sets output, internal relay, or shift register bit | 5-3 |
| SFR | Shift Register | Forward shift register | 5-22 |
| SFRN | Shift Register Not | Reverse shift register | 5-22 |
| SOTD | Single Output Down | Falling-edge differentiation output | 5-26 |
| SOTU | Single Output Up | Rising-edge differentiation output | 5-26 |
| TIM | 100-ms Timer | Subtracting 100-ms timer (0 to 6553.5 sec) | 5-7 |
| TIMO | 100-ms Off-delay Timer | Subtracting 100-ms off-delay timer (0 to 6553.5 sec) | 5-10 |
| TMH | 10-ms Timer | Subtracting 10-ms timer (0 to 655.35 sec) | 5-7 |

4: INSTRUCTIONS REFERENCE

| Symbol | Name | Function | See Page |
|---------------|-----------------------|---|-----------------|
| TMHO | 10-ms Off-delay Timer | Subtracting 10-ms off-delay timer (0 to 655.35 sec) | 5-10 |
| TML | 1-sec Timer | Subtracting 1-sec timer (0 to 65535 sec) | 5-7 |
| TMLO | 1-sec Off-delay Timer | Subtracting 1-sec off-delay timer (0 to 65535 sec) | 5-10 |
| TMS | 1-ms Timer | Subtracting 1-ms timer (0 to 65.535 sec) | 5-7 |
| TMSO | 1-ms Off-delay Timer | Subtracting 1-ms off-delay timer (0 to 65.535 sec) | 5-10 |

Advanced Instruction List

| Group | Symbol | Name | Valid Data Type | | | | | See Page |
|----------------------------|--------|---|-----------------|---|---|---|---|----------|
| | | | W | I | D | L | F | |
| NOP | NOP | No Operation | | | | | | 4-14 |
| Move | MOV | Move | X | X | X | X | X | 6-1 |
| | MOVN | Move Not | X | X | X | X | | 6-5 |
| | IMOV | Indirect Move | X | | X | | X | 6-6 |
| | IMOVN | Indirect Move Not | X | | X | | | 6-8 |
| | BMOV | Block Move | X | | | | | 6-9 |
| | IBMV | Indirect Bit Move | X | | | | | 6-10 |
| | IBMVN | Indirect Bit Move Not | X | | | | | 6-12 |
| | NSET | N Data Set | X | X | X | X | X | 6-13 |
| | NRS | N Data Repeat Set | X | X | X | X | X | 6-14 |
| | XCHG | Exchange | X | | X | | | 6-15 |
| | TCCST | Timer/Counter Current Value Store | X | | X | | | 6-16 |
| Data Comparison | CMP= | Compare Equal To | X | X | X | X | X | 7-1 |
| | CMP<> | Compare Unequal To | X | X | X | X | X | 7-1 |
| | CMP< | Compare Less Than | X | X | X | X | X | 7-1 |
| | CMP> | Compare Greater Than | X | X | X | X | X | 7-1 |
| | CMP<= | Compare Less Than or Equal To | X | X | X | X | X | 7-1 |
| | CMP>= | Compare Greater Than or Equal To | X | X | X | X | X | 7-1 |
| | ICMP>= | Interval Compare Greater Than or Equal To | X | X | X | X | X | 7-6 |
| | LC= | Load Compare Equal To | X | X | X | X | X | 7-8 |
| | LC<> | Load Compare Unequal To | X | X | X | X | X | 7-8 |
| | LC< | Load Compare Less Than | X | X | X | X | X | 7-8 |
| | LC> | Load Compare Greater Than | X | X | X | X | X | 7-8 |
| | LC<= | Load Compare Less Than or Equal To | X | X | X | X | X | 7-8 |
| | LC>= | Load Compare Greater Than or Equal To | X | X | X | X | X | 7-8 |
| Binary Arithmetic | ADD | Addition | X | X | X | X | X | 8-1 |
| | SUB | Subtraction | X | X | X | X | X | 8-1 |
| | MUL | Multiplication | X | X | X | X | X | 8-1 |
| | DIV | Division | X | X | X | X | X | 8-1 |
| | INC | Increment | X | X | X | X | | 8-13 |
| | DEC | Decrement | X | X | X | X | | 8-13 |
| | ROOT | Root | X | | X | | X | 8-14 |
| | SUM | Sum (ADD) | | X | X | X | X | X |
| Sum (XOR) | | | X | | | | | 8-15 |
| Boolean Computation | ANDW | AND Word | X | | X | | | 9-1 |
| | ORW | OR Word | X | | X | | | 9-1 |
| | XORW | Exclusive OR Word | X | | X | | | 9-1 |
| Shift and Rotate | SFTL | Shift Left | | | | | | 10-1 |
| | SFTR | Shift Right | | | | | | 10-3 |
| | BCDLS | BCD Left Shift | | | X | | | 10-5 |
| | WSFT | Word Shift | X | | | | | 10-7 |
| | ROTL | Rotate Left | X | | X | | | 10-8 |
| | ROTR | Rotate Right | X | | X | | | 10-10 |

4: INSTRUCTIONS REFERENCE

| Group | Symbol | Name | Valid Data Type | | | | | See Page |
|-----------------------|----------------------------|--------------------------|-----------------|---|---|---|-------|----------|
| | | | W | I | D | L | F | |
| Data Conversion | HTOB | Hex to BCD | X | | X | | | 11-1 |
| | BTOH | BCD to Hex | X | | X | | | 11-3 |
| | HTOA | Hex to ASCII | X | | | | | 11-5 |
| | ATOH | ASCII to Hex | X | | | | | 11-7 |
| | BTOA | BCD to ASCII | X | | X | | | 11-9 |
| | ATOB | ASCII to BCD | X | | X | | | 11-12 |
| | ENCO | Encode | | | | | | 11-15 |
| | DECO | Decode | | | | | | 11-16 |
| | BCNT | Bit Count | | | | | | 11-17 |
| | ALT | Alternate Output | | | | | | 11-18 |
| | CVDT | Convert Data Type | X | X | X | X | X | 11-19 |
| | DTDV | Data Divide | X | | | | | 11-21 |
| | DTCB | Data Combine | X | | | | | 11-22 |
| SWAP | Data Swap | X | | X | | | 11-23 | |
| Week Programmer | WEEK | Weekly Timer | | | | | | 12-1 |
| | YEAR | Yearly Timer | | | | | | 12-11 |
| Interface | MSG | Message | | | | | | 13-1 |
| User Communication | TXD2 | Transmit 2 | | | | | | 25-1 |
| | TXD3 | Transmit 3 | | | | | | 25-1 |
| | RXD2 | Receive 2 | | | | | | 25-7 |
| | RXD3 | Receive 3 | | | | | | 25-7 |
| Program Branching | LABEL | Label | | | | | | 14-1 |
| | LJMP | Label Jump | | | | | | 14-1 |
| | LCAL | Label Call | | | | | | 14-3 |
| | LRET | Label Return | | | | | | 14-3 |
| | DJNZ | Decrement Jump Non-zero | | | | | | 14-5 |
| | DI | Disable Interrupt | | | | | | 16-1 |
| | EI | Enable Interrupt | | | | | | 16-1 |
| | IOREF | I/O Refresh | | | | | | 15-1 |
| HSCRF | High-speed Counter Refresh | | | | | | 15-3 | |
| Coordinate Conversion | XYFS | XY Format Set | X | X | | | | 17-1 |
| | CVXTY | Convert X to Y | X | X | | | | 17-2 |
| | CVYTX | Convert Y to X | X | X | | | | 17-3 |
| | AVRG | Average | X | X | X | X | X | 18-1 |
| Pulse | PULS1 | Pulse Output 1 | | | | | | 19-1 |
| | PULS2 | Pulse Output 2 | | | | | | 19-1 |
| | PULS3 | Pulse Output 3 | | | | | | 19-1 |
| | PULS4 | Pulse Output 4 | | | | | | 19-1 |
| | PWM1 | Pulse Width Modulation 1 | | | | | | 19-8 |
| | PWM2 | Pulse Width Modulation 2 | | | | | | 19-8 |
| | PWM3 | Pulse Width Modulation 3 | | | | | | 19-8 |
| | PWM4 | Pulse Width Modulation 4 | | | | | | 19-8 |
| | RAMP1 | Ramp Pulse Output 1 | | | | | | 19-15 |
| | RAMP2 | Ramp Pulse Output 2 | | | | | | 19-15 |
| | ZRN1 | Zero Return 1 | | | | | | 19-26 |
| | ZRN2 | Zero Return 2 | | | | | | 19-26 |
| | ARAMP1 | Advanced Ramp 1 | | | | | | 19-32 |
| | ARAMP2 | Advanced Ramp 2 | | | | | | 19-32 |
| Dual / Teaching Timer | DTML | 1-sec Dual Timer | | | | | | 20-1 |
| | DTIM | 100-ms Dual Timer | | | | | | 20-1 |
| | DTMH | 10-ms Dual Timer | | | | | | 20-1 |
| | DTMS | 1-ms Dual Timer | | | | | | 20-1 |
| | TTIM | Teaching Timer | | | | | | 20-3 |

| Group | Symbol | Name | Valid Data Type | | | | | See Page |
|-------------------------------|-------------|------------------------|-----------------|---|---|---|------|----------|
| | | | W | I | D | L | F | |
| Trigonometric Function | RAD | Degree to Radian | | | | | X | 21-1 |
| | DEG | Radian to Degree | | | | | X | 21-2 |
| | SIN | Sine | | | | | X | 21-3 |
| | COS | Cosine | | | | | X | 21-4 |
| | TAN | Tangent | | | | | X | 21-5 |
| | ASIN | Arc Sine | | | | | X | 21-6 |
| | ACOS | Arc Cosine | | | | | X | 21-7 |
| ATAN | Arc Tangent | | | | | X | 21-8 | |
| Logarithm / Power | LOGE | Natural Logarithm | | | | | X | 22-1 |
| | LOG10 | Common Logarithm | | | | | X | 22-2 |
| | EXP | Exponent | | | | | X | 22-3 |
| | POW | Power | | | | | X | 22-4 |
| File Data Processing | FIFO | FIFO Format | X | | | | | 23-1 |
| | FIEX | First-In Execute | X | | | | | 23-3 |
| | FOEX | First-Out Execute | X | | | | | 23-3 |
| | NDSRC | N Data Search | X | X | X | X | X | 23-5 |
| Clock | TADD | Time Addition | | | | | | 24-1 |
| | TSUB | Time Subtraction | | | | | | 24-5 |
| | HTOS | HMS to Sec | | | | | | 24-9 |
| | STOH | Sec to HMS | | | | | | 24-10 |
| | HOUR | Hour Meter | | | | | | 24-11 |
| Ethernet Instructions | ETXD | Transmit over Ethernet | | | | | | 25-21 |
| | ERXD | Receive over Ethernet | | | | | | 25-21 |
| Data Logging | DLOG | Data Logging | | | | | | 26-1 |
| | TRACE | Data Trace | | | | | | 26-8 |
| Script | SCRPT | Script | X | X | X | X | X | 27-1 |
| PID | PID | PID | | | | | | 28-1 |

Advanced Instruction Applicable SmartAXIS

Applicable advanced instructions depend on the SmartAXIS type as listed in the table below.

| Group | Symbol | FT1A-12 | | FT1A-24 | | FT1A-40 | | FT1A-48 | | FT1A-Touch |
|----------------------------|--------|---------|----|---------|----|---------|----|---------|----|------------|
| | | AC | DC | AC | DC | AC | DC | AC | DC | |
| NOP | NOP | X | X | X | X | X | X | X | X | X |
| Move | MOV | X | X | X | X | X | X | X | X | X |
| | MOVN | X | X | X | X | X | X | X | X | X |
| | IMOV | X | X | X | X | X | X | X | X | X |
| | IMOVN | X | X | X | X | X | X | X | X | X |
| | BMOV | X | X | X | X | X | X | X | X | X |
| | IBMV | X | X | X | X | X | X | X | X | X |
| | IBMVN | X | X | X | X | X | X | X | X | X |
| | NSET | X | X | X | X | X | X | X | X | X |
| | NRS | X | X | X | X | X | X | X | X | X |
| | XCHG | X | X | X | X | X | X | X | X | X |
| TCCST | X | X | X | X | X | X | X | X | X | |
| Data Comparison | CMP= | X | X | X | X | X | X | X | X | X |
| | CMP<> | X | X | X | X | X | X | X | X | X |
| | CMP< | X | X | X | X | X | X | X | X | X |
| | CMP> | X | X | X | X | X | X | X | X | X |
| | CMP<= | X | X | X | X | X | X | X | X | X |
| | CMP>= | X | X | X | X | X | X | X | X | X |
| | ICMP>= | X | X | X | X | X | X | X | X | X |
| | LC= | X | X | X | X | X | X | X | X | X |
| | LC<> | X | X | X | X | X | X | X | X | X |
| | LC< | X | X | X | X | X | X | X | X | X |
| | LC> | X | X | X | X | X | X | X | X | X |
| | LC<= | X | X | X | X | X | X | X | X | X |
| LC>= | X | X | X | X | X | X | X | X | X | |
| Binary Arithmetic | ADD | X | X | X | X | X | X | X | X | X |
| | SUB | X | X | X | X | X | X | X | X | X |
| | MUL | X | X | X | X | X | X | X | X | X |
| | DIV | X | X | X | X | X | X | X | X | X |
| | INC | X | X | X | X | X | X | X | X | X |
| | DEC | X | X | X | X | X | X | X | X | X |
| | ROOT | X | X | X | X | X | X | X | X | X |
| | SUM | X | X | X | X | X | X | X | X | X |
| Boolean Computation | ANDW | X | X | X | X | X | X | X | X | X |
| | ORW | X | X | X | X | X | X | X | X | X |
| | XORW | X | X | X | X | X | X | X | X | X |
| Shift and Rotate | SFTL | X | X | X | X | X | X | X | X | X |
| | SFTR | X | X | X | X | X | X | X | X | X |
| | BCDLS | X | X | X | X | X | X | X | X | X |
| | WSFT | X | X | X | X | X | X | X | X | X |
| | ROTL | X | X | X | X | X | X | X | X | X |
| | ROTR | X | X | X | X | X | X | X | X | X |

| Group | Symbol | FT1A-12 | | FT1A-24 | | FT1A-40 | | FT1A-48 | | FT1A-Touch |
|------------------------------|--------|----------|----------|----------|----------|----------|----------|----------|----------|------------|
| | | AC | DC | AC | DC | AC | DC | AC | DC | |
| Data Conversion | HTOB | X | X | X | X | X | X | X | X | X |
| | BTOH | X | X | X | X | X | X | X | X | X |
| | HTOA | X | X | X | X | X | X | X | X | X |
| | ATOH | X | X | X | X | X | X | X | X | X |
| | BTOA | X | X | X | X | X | X | X | X | X |
| | ATOB | X | X | X | X | X | X | X | X | X |
| | ENCO | X | X | X | X | X | X | X | X | X |
| | DECO | X | X | X | X | X | X | X | X | X |
| | BCNT | X | X | X | X | X | X | X | X | X |
| | ALT | X | X | X | X | X | X | X | X | X |
| | CVDT | X | X | X | X | X | X | X | X | X |
| | DTDV | X | X | X | X | X | X | X | X | X |
| | DTCB | X | X | X | X | X | X | X | X | X |
| | SWAP | X | X | X | X | X | X | X | X | X |
| Week Programmer | WEEK | X | X | X | X | X | X | X | X | X |
| | YEAR | X | X | X | X | X | X | X | X | X |
| Display | MSG | X (Note) | X (Note) | X (Note) | X (Note) | X (Note) | X (Note) | X (Note) | X (Note) | – |
| User Communication | TXD2 | X | X | X | X | X | X | X | X | X |
| | TXD3 | – | – | – | – | X | X | X | X | X |
| | RXD2 | – | – | X | X | X | X | X | X | X |
| | RXD3 | – | – | – | – | X | X | X | X | X |
| Program Branching | LABEL | X | X | X | X | X | X | X | X | X |
| | LJMP | X | X | X | X | X | X | X | X | X |
| | LCAL | X | X | X | X | X | X | X | X | X |
| | LRET | X | X | X | X | X | X | X | X | X |
| | DJNZ | X | X | X | X | X | X | X | X | X |
| | DI | X | X | X | X | X | X | X | X | X |
| | EI | X | X | X | X | X | X | X | X | X |
| | IOREF | X | X | X | X | X | X | X | X | X |
| | HSCRF | – | X | – | X | – | X | – | X | X |
| Coordinate Conversion | XYFS | X | X | X | X | X | X | X | X | X |
| | CVXTY | X | X | X | X | X | X | X | X | X |
| | CVYTX | X | X | X | X | X | X | X | X | X |
| | AVRG | X | X | X | X | X | X | X | X | X |

Note: MSG instructions can be used with Pro series only.

4: INSTRUCTIONS REFERENCE

| Group | Symbol | FT1A-12 | | FT1A-24 | | FT1A-40 | | FT1A-48 | | FT1A-Touch |
|------------------------|--------|---------|----|---------|----|--------------|--------------|--------------|--------------|--------------|
| | | AC | DC | AC | DC | AC | DC | AC | DC | |
| Pulse | PULS1 | - | - | - | - | - | X | X | X | - |
| | PULS2 | - | - | - | - | - | X | X | X | - |
| | PULS3 | - | - | - | - | - | X (Note1) | X | X | - |
| | PULS4 | - | - | - | - | - | X (Note1) | X | X | - |
| | PWM1 | - | - | - | - | - | X | X | X | - |
| | PWM2 | - | - | - | - | - | X | X | X | - |
| | PWM3 | - | - | - | - | - | X (Note1) | X | X | - |
| | PWM4 | - | - | - | - | - | X (Note1) | X | X | - |
| | RAMP1 | - | - | - | - | - | X | X | X | - |
| | RAMP2 | - | - | - | - | - | X (Note2) | X (Note2) | X (Note2) | - |
| | ZRN1 | - | - | - | - | - | X | X | X | - |
| | ZRN2 | - | - | - | - | - | X | X | X | - |
| | ARAMP1 | - | - | - | - | - | X | X | X | - |
| ARAMP2 | - | - | - | - | - | X (Note2) | X (Note2) | X (Note2) | - | |
| Dual / Teaching Timer | DTML | X | X | X | X | X | X | X | X | X |
| | DTIM | X | X | X | X | X | X | X | X | X |
| | DTMH | X | X | X | X | X | X | X | X | X |
| | DTMS | X | X | X | X | X | X | X | X | X |
| | TTIM | X | X | X | X | X | X | X | X | X |
| Trigonometric Function | RAD | X | X | X | X | X | X | X | X | X |
| | DEG | X | X | X | X | X | X | X | X | X |
| | SIN | X | X | X | X | X | X | X | X | X |
| | COS | X | X | X | X | X | X | X | X | X |
| | TAN | X | X | X | X | X | X | X | X | X |
| | ASIN | X | X | X | X | X | X | X | X | X |
| | ACOS | X | X | X | X | X | X | X | X | X |
| | ATAN | X | X | X | X | X | X | X | X | X |
| Logarithm / Power | LOGE | X | X | X | X | X | X | X | X | X |
| | LOG10 | X | X | X | X | X | X | X | X | X |
| | EXP | X | X | X | X | X | X | X | X | X |
| | POW | X | X | X | X | X | X | X | X | X |
| File Data Processing | FIFO | X | X | X | X | X | X | X | X | X |
| | FIEX | X | X | X | X | X | X | X | X | X |
| | FOEX | X | X | X | X | X | X | X | X | X |
| | NDSRC | X | X | X | X | X | X | X | X | X |
| Clock | TADD | X | X | X | X | X | X | X | X | X |
| | TSUB | X | X | X | X | X | X | X | X | X |
| | HTOS | X | X | X | X | X | X | X | X | X |
| | STOH | X | X | X | X | X | X | X | X | X |
| | HOUR | X | X | X | X | X | X | X | X | X |
| Ethernet Instructions | ETXD | - | - | X | X | X | X | X | X | - |
| | ERXD | - | - | X | X | X | X | X | X | - |
| Data Logging | DLOG | - | - | - | - | X | X | X | X | - |
| | TRACE | - | - | - | - | X | X | X | X | - |
| Script | SCRPT | X | X | X | X | X | X | X | X | X |
| PID | PID | - | - | - | - | - | - | - | - | X (Note3) |

Note1: When using RAMP1 in single-pulse output mode, PULS3 and PWM3 cannot be used. When using RAMP2 in single-pulse output mode, PULS4 and PWM4 cannot be used.

Note2: When using RAMP1 and ARAMP1 in dual-pulse output mode, RAMP2 and ARAMP2 cannot be used.

Note3: PID instruction can be used with FT1A-*14KA-* and FT1A-*14SA-* only.

Structure of an Advanced Instruction

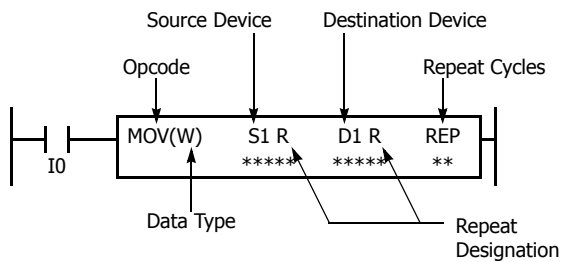

Repeat Designation

Specifies whether repeat is used for the device or not.

Repeat Cycles

Specifies the quantity of repeat cycles: 1 through 99.

Opcode

The opcode is a symbol used to identify the advanced instruction.

Data Type

Specifies word (W), integer (I), double word (D), long (L), or float (F) data.

Source Device

The source device specifies the 16- or 32-bit data to be processed by the advanced instruction. Some advanced instructions require two source devices.

Destination Device

The destination device specifies the 16- or 32-bit data to store the result of the advanced instruction. Some advanced instructions require two destination devices.

Input Condition for Advanced Instructions

Almost all advanced instructions must be preceded by a contact, except NOP (no operation), LABEL (label), and LRET (label return) instructions. The input condition can be programmed using a bit device such as input, output, internal relay, or shift register. Timer and counter can also be used as an input condition to turn on the contact when the timer times out or the counter counts out.

While the input condition is on, the advanced instruction is executed in each scan. To execute the advanced instruction only at the rising or falling edge of the input, use the SOTU or SOTD instruction.

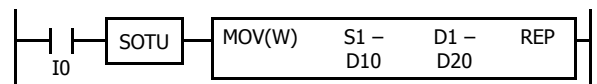

While the input condition is off, the advanced instruction is not executed and device statuses are held.

Source and Destination Devices

The source and destination devices specify 16- or 32-bit data, depending on the selected data type. When a bit device such as input, output, internal relay, or shift register is designated as a source or destination device, 16 or 32 points starting with the designated number are processed as source or destination data. When a word device such as timer or counter is designated as a source device, the current value is read as source data. When a timer or counter is designated as a destination device, the result of the advanced instruction is set to the preset value for the timer or counter. When a data register is designated as a source or destination device, the data is read from or written to the designated data register.

Using Timer or Counter as Source Device

Since all timer instructions—TML (1-sec timer), TIM (100-ms timer), TMH (10-ms timer), and TMS (1-ms timer)—subtract from the preset value, the current value is decremented from the preset value and indicates the remaining time. As described above, when a timer is designated as a source device of an advanced instruction, the current value, or the remaining time, of the timer is read as source data. Adding counters CNT start counting at 0, and the current value is incremented up to the preset value.

Reversible counters CDP and CUD start counting at the preset value and the current value is incremented or decremented from the preset value. When any counter is designated as a source device of an advanced instruction, the current value is read as source data.

Using Timer or Counter as Destination Device

As described above, when a timer or counter is designated as a destination device of an advanced instruction, the result of the advanced instruction is set to the preset value of the timer or counter. Timer and counter preset values can be 0 through 65535.

When a timer or counter preset value is designated using a data register, the timer or counter cannot be designated as a destination of an advanced instruction. When executing such an advanced instruction, a user program execution error will result. For details of user program execution error, see Chapter 13 "Troubleshooting" - "User Program Execution Error" in the SmartAXIS Pro/Lite User's Manual.

Note: When a user program execution error occurs, the result is not set to the destination.

Data Types for Advanced Instructions

When using move, data comparison, binary arithmetic, Boolean computation, bit shift/rotate, data conversion, and coordinate conversion instructions, data types can be selected from word (W), integer (I), double word (D), long (L), or float (F). For other advanced instructions, the data is processed in units of 16-bit word.

| Data Type | Symbol | Bits | Quantity of Data Registers Used | Range of Decimal Values |
|--------------------------------|--------|---------|---------------------------------|---|
| Word (Unsigned 16 bits) | W | 16 bits | 1 | 0 to 65,535 |
| Integer (Signed 15 bits) | I | 16 bits | 1 | -32,768 to 32,767 |
| Double Word (Unsigned 32 bits) | D | 32 bits | 2 | 0 to 4,294,967,295 |
| Long (Signed 31 bits) | L | 32 bits | 2 | -2,147,483,648 to 2,147,483,647 |
| Float (Floating point) | F | 32 bits | 2 | -3.402823×10 ³⁸ to 3.402823×10 ³⁸ |

Decimal Values and Hexadecimal Storage (Word, Integer, Double, and Long Data)

The following table shows hexadecimal equivalents which are stored in the CPU, as a result of addition and subtraction of the decimal values shown:

| Data Type | Result of Addition | Hexadecimal Storage | Result of Subtraction | Hexadecimal Storage |
|-------------|--------------------|---------------------|-----------------------|---------------------|
| Word | 0 | 0000 | 65535 | FFFF |
| | 65535 | FFFF | 0 | 0000 |
| | 131071 | (CY) FFFF | -1 | (BW) FFFF |
| | | | -65535 | (BW) 0001 |
| Integer | | | -65536 | (BW) 0000 |
| | 65534 | (CY) 7FFE | 65534 | (BW) 7FFE |
| | 32768 | (CY) 0000 | 32768 | (BW) 0000 |
| | 32767 | 7FFF | 32767 | 7FFF |
| | 0 | 0000 | 0 | 0000 |
| | -1 | FFFF | -1 | FFFF |
| | -32767 | 8001 | -32767 | 8001 |
| | -32768 | 8000 | -32768 | 8000 |
| Double Word | -32769 | (CY) FFFF | -32769 | (BW) FFFF |
| | -65535 | (CY) 8001 | -65535 | (BW) 8001 |
| | 0 | 00000000 | 4294967295 | FFFFFFFF |
| | 4294967295 | FFFFFFFF | 0 | 00000000 |
| Long | 8589934591 | (CY) FFFFFFFF | -1 | (BW) FFFFFFFF |
| | | | -4294967295 | (BW) 00000001 |
| | | | -4294967296 | (BW) 00000000 |
| | 4294967294 | (CY) 7FFFFFFE | 4294967294 | (BW) 7FFFFFFE |
| | 2147483648 | (CY) 00000000 | 2147483648 | (BW) 00000000 |
| | 2147483647 | 7FFFFFFF | 2147483647 | 7FFFFFFF |
| | 0 | 00000000 | 0 | 00000000 |
| | -1 | FFFFFFFF | -1 | FFFFFFFF |
| -2147483647 | 80000001 | -2147483647 | 80000001 | |
| -2147483648 | 80000000 | -2147483648 | 80000000 | |
| -2147483649 | (CY) FFFFFFFF | -2147483649 | (BW) FFFFFFFF | |
| -4294967295 | (CY) 80000001 | -4294967295 | (BW) 80000001 | |

Floating-Point Data Format

The SmartAXIS can specify floating-point data (F) for advanced instructions. Like double word (D) and long integer (L) data, floating-point data also uses two consecutive data registers to execute advanced instructions. The SmartAXIS supports the floating-point data based on the single storage format of the IEEE (The Institute of Electrical and Electronics Engineers) Standard 754.

Single Storage Format

The IEEE single storage format consists of three fields: a 23-bit fraction, *f*; an 8-bit biased exponent, *e*; and 1-bit sign, *s*. These fields are stored contiguously in one 32-bit word, as shown in the figure below. Bits 0:22 contain the 23-bit fraction, *f*, with bit 0 being the least significant bit of the fraction and bit 22 being the most significant; bits 23:30 contain the 8-bit biased exponent, *e*, with bit 23 being the least significant bit of the biased exponent and bit 30 being the most significant; and the highest-order bit 31 contains the sign bit, *s*.

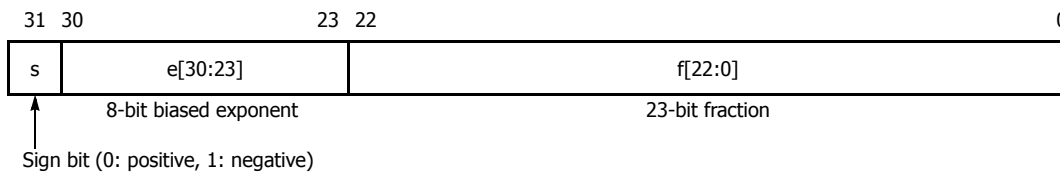

Single Storage Format

The table below shows the correspondence between the values of the three constituent fields *s*, *e*, and *f* and the value represented by the single storage format bit pattern. When any value out of the bit pattern is entered to the advanced instruction or when execution of advanced instructions, such as division by zero, has produced any value out of the bit pattern, a user program execution error will result, turning on special internal relay M8004 and the ERR LED on the SmartAXIS.

| Value | Exponent field <i>e</i> | Fraction field <i>f</i> | Representation in WindLDR |
|----------------------------|-------------------------|-------------------------|--|
| ±0 | <i>e</i> =0 | <i>f</i> =0 | 0.0 |
| Denormal numbers | <i>e</i> =0 | <i>f</i> ≠0 | -1.175495E-38 to 1.175495E-38 |
| Normal numbers | 0< <i>e</i> <255 | Arbitrary | -3.402823E+38 to -1.175495E-38 1.175495E-38 to 3.402823E+38 |
| ±∞ (± infinities) | <i>e</i> =255 | <i>f</i> =0 | INF |
| NaNs (Not a number values) | | <i>f</i> ≠0 | NAN |

Carry and Borrow in Floating-Point Data Processing

When advanced instructions involving floating-point data are executed, special internal relay M8003 (carry and borrow) is updated.

| M8003 | Execution Result | Value |
|-------|------------------|---|
| 1 | ≠ 0 | Overflow (exceeds the range between -3.402823×10^{38} and 3.402823×10^{38}) |
| 1 | 0 | Not zero (within the range between $-1.175495 \times 10^{-38}$ and 1.175495×10^{-38}) |
| 0 | 0 | Zero |

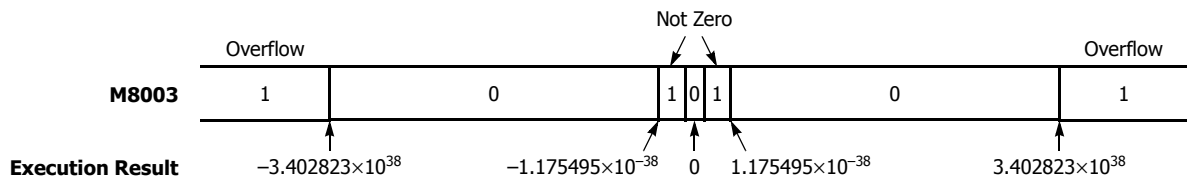

32-bit Data Storage

When double-word (D) or long (L) data is selected, the data is stored in consecutive devices in the following manner according to the 32-bit data storage setting configured in **Function Area Settings** under **Device Settings**.

For applicable devices and instructions, see Chapter 5 "Special Functions" – "32-bit Data Storage Setting" in the SmartAXIS Pro/Lite User's Manual.

Word devices: The data storage when **From Upper Word** is selected under **Device Settings**

When D0 is specified as the source or destination device, the upper word is stored in D0 and the lower word is stored in D1.

Double word data (constant)

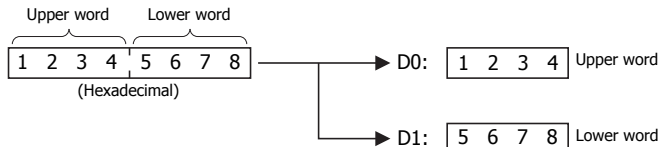

The data storage when **From Lower Word** is selected under **Device Settings**

When D0 is specified as the source or destination device, the lower word is stored in D0 and the upper word is stored in D1.

Double word data (constant)

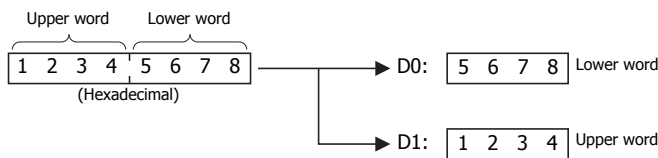

Bit devices: The data storage when **From Upper Word** is selected under **Device Settings**

When R0 is specified as the source or destination device, the upper word is stored in R0 to R15 and the lower word is stored in R16 to R31.

Double word data (constant)

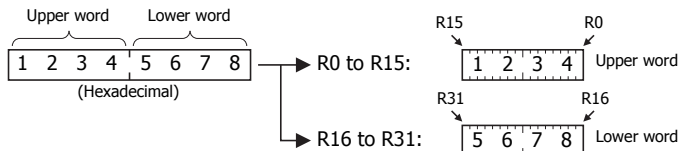

The data storage when **From Lower Word** is selected under **Device Settings**

When R0 is specified as the source or destination device, the lower word is stored in R0-R15 and the upper word is stored in R16-R31.

Double word data (constant)

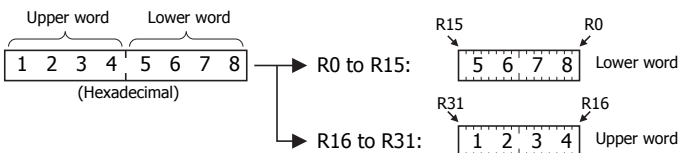

User Program Execution Errors

When an advanced instruction is executed, a user program execution error occurs when any of the following conditions are met.

- the result of the advanced instruction is invalid
- source or destination device that is indirectly specified in the advanced instruction exceeds the valid device range
- the advanced instruction does not operate correctly

For example, the data in the source device does not comply with the normal floating-point format when the data type is Float (F).

When a user program execution error occurs, special internal relay M8004 turns on and the corresponding error code is stored in special data register D8006. For details about the error codes, see Chapter 13 "Troubleshooting" – "User Program Execution Error" in the SmartAXIS Pro/Lite User's Manual.

When a user program execution error occurs, instructions operate as follows:

- When the source data is invalid, the execution of the advanced instruction is canceled and the data in the destination device is not changed.
- When the execution result is invalid, a value is stored in the destination device.
For details on stored values, see the descriptions of relevant instructions.
- If a user program execution error occurred during a repeat operation, the operation is canceled and the next repeat operation is executed. M8004 is retained even when no further user program execution errors occur during subsequent repeat operations.

Example: User program execution error during a repeat operation

When the source data does not comply with the normal floating-point format.

When the second repeat operation is executed, special internal relay M8004 turns on because the source data is not a normal number in floating-point format.

The second repeat operation is canceled and the third repeat operation is executed.

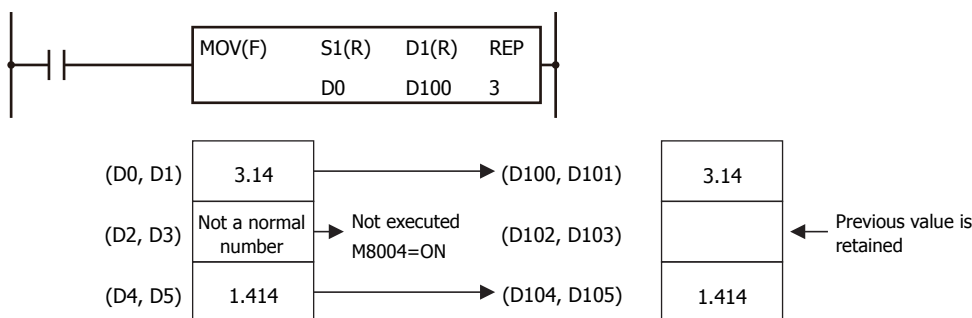

Carry and Borrow

When the result of an operation exceeds the valid device range, a carry (CY) or borrow (BW) occurs.

Carrying and borrowing occur in the following conditions according to the data type:

| Data Type | Status |
|-------------|---|
| Word | Exceeds range between 0 and 65,535 |
| Integer | Exceeds range between -32,768 and 32,767 |
| Double Word | Exceeds range between 0 and 4,294,967,295 |
| Long | Exceeds range between -2,147,483,648 and 2,147,483,647 |
| Float | If an overflow or underflow occurs For details on overflow and underflow, see "Carry and Borrow in Floating-Point Data Processing" on page 4-11. |

When a carry or borrow occurs, special internal relay M8003 (carry and borrow) turns on.

For example, when D0 has a value of FFFF (hex) and +1 is added using an INC instruction, the result is 10000 (hex), but when the data type is Word (W), 0000 (hex) is stored in D0 and 1 is stored in M8003.

Discontinuity of Device Areas

Each device area is discrete and does not continue, for example, from input to output or from output to internal relay. In addition, special internal relays M8000 through M8177 are in a separate area from internal relays M0 through M1277. Data registers D0 through D999, non-retentive data registers D1000 through D1999, and special data registers D8000 through D8199 are in separate areas and do not continue with each other.

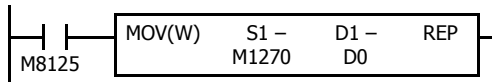

The internal relay ends at M1277. Since the MOV (move) instruction reads 16 internal relays, the last internal relay exceeds the valid range, resulting in a user program syntax error.

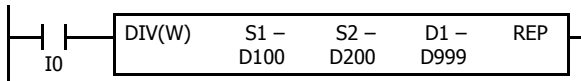

This program results in a user program syntax error. The destination of the DIV (division) instruction requires two data registers D999 and D1000. Since D1000 exceeds the valid range, a user program syntax error occurs.

Advanced instructions execute operation only on the available devices in the valid area. If a user program syntax error is found during programming, WindLDR rejects the program instruction and shows an error message.

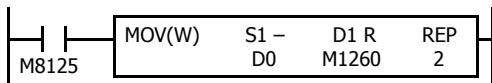

The MOV (move) instruction sets data of data register D0 to 16 internal relays M1260 through M1277 in the first repeat cycle. The destination of the second cycle is the next 16 internal relays M1280 through M1297, which are invalid, resulting in a user program syntax error.

For details about repeat operations of each advanced instruction, see the following chapters.

NOP (No Operation)

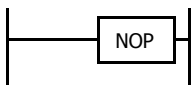

No operation is executed by the NOP instruction.

The NOP instruction may serve as a place holder. It can also be used to add a delay to the CPU scan time, in order to simulate communication with a machine or application, for debugging purposes.

The NOP instruction does not require an input and device.

Details of the other advanced instructions are described in the following chapters.

5: BASIC INSTRUCTIONS

Introduction

This chapter describes programming of the basic instructions, available devices, and sample programs.

All basic instructions are available on all SmartAXIS.

LOD (Load) and LODN (Load Not)

The LOD instruction starts the logical operation with a NO (normally open) contact. The LODN instruction starts the logical operation with a NC (normally closed) contact.

A total of eight LOD and/or LODN instructions can be programmed consecutively.

Ladder Diagram

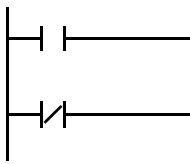

Valid Devices

| Instruction | I | Q | M | T | C | R | D |
|-------------|-------------------|-------------------|-----------|-------|-------|-------|----------------|
| LOD | 0-35 40-75 | 0-21 40-61 | 0-1277 | 0-199 | 0-199 | 0-127 | 0.0-1999.15 |
| LODN | 80-115 120-155 | 80-101 120-141 | 8000-8177 | | | | 8000.0-8199.15 |

The valid device range depends on the SmartAXIS type. For details, see "Device Addresses" on page 3-1.

Data registers can be used as bit devices with the data register number and the bit position separated by a period.

OUT (Output) and OUTN (Output Not)

The OUT instruction outputs the result of bit logical operation to the specified device. The OUTN instruction outputs the inverted result of bit logical operation to the specified device.

Ladder Diagram

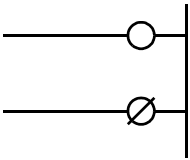

Valid Devices

| Instruction | I | Q | M | T | C | R | D |
|-------------|---|-------------------|-----------|---|---|---|----------------|
| OUT | | 0-21 40-61 | 0-1277 | | | | 0.0-1999.15 |
| OUTN | — | 80-101 120-141 | 8000-8177 | — | — | — | 8000.0-8199.15 |

The valid device range depends on the SmartAXIS type. For details, see "Device Addresses" on page 3-1.

Data registers can be used as bit devices with the data register number and the bit position separated by a period.

Note: For restrictions on ladder programming of OUT and OUTN instructions, see "Restriction on Ladder Programming" on page 5-31.

Multiple OUT and OUTN

There is no limit to the number of OUT and OUTN instructions that can be programmed into one rung.

Programming multiple outputs of the same output number is not recommended. However, if doing so, it is good practice to separate the outputs with the JMP/JEND set of instructions, or the MCS/MCR set of instructions. These instructions are detailed later in this chapter.

When the same output number is programmed more than once within one scan, the output nearest to the END instruction is given priority for outputting. In the example on the right, output Q0 is off.

Ladder Diagram

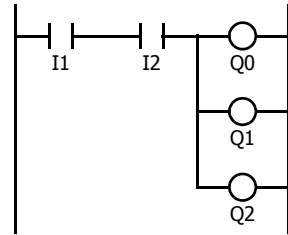

Ladder Diagram

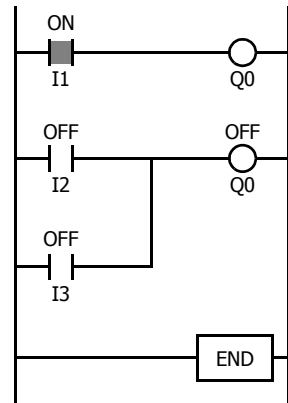

Examples: LOD (Load), OUT (Output), and NOT

Ladder Diagram

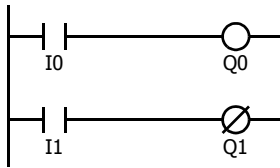

Program List

| Instruction | Data |
|-------------|------|
| LOD | I0 |
| OUT | Q0 |
| LOD | I1 |
| OUTN | Q1 |

Timing Chart

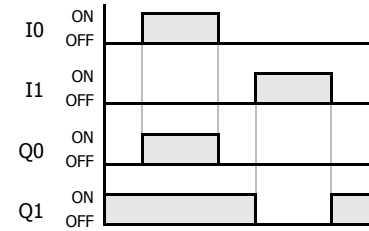

Ladder Diagram

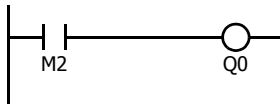

Program List

| Instruction | Data |
|-------------|------|
| LOD | M2 |
| OUT | Q0 |

Ladder Diagram

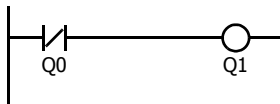

Program List

| Instruction | Data |
|-------------|------|
| LODN | Q0 |
| OUT | Q1 |

Ladder Diagram

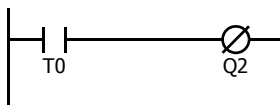

Program List

| Instruction | Data |
|-------------|------|
| LOD | T0 |
| OUTN | Q2 |

Ladder Diagram

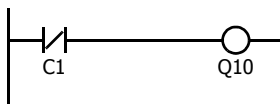

Program List

| Instruction | Data |
|-------------|------|
| LODN | C1 |
| OUT | Q10 |

SET and RST (Reset)

The SET and RST (reset) instructions are used to set (on) or reset (off) outputs, internal relays, and shift register bits. The same output can be set and reset many times within a program. SET and RST instructions operate in every scan while the input is on.

Ladder Diagram

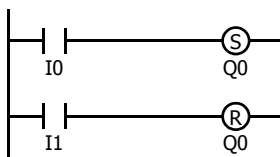

Program List

| Instruction | Data |
|-------------|------|
| LOD | I0 |
| SET | Q0 |
| LOD | I1 |
| RST | Q0 |

Timing Chart

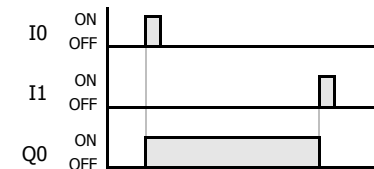

Valid Devices

| Instruction | I | Q | M | T | C | R | D |
|-------------|---|-------------------|-----------|---|---|-------|----------------|
| SET | — | 0-21 40-61 | 0-1277 | — | — | 0-127 | 0.0-1999.15 |
| RST | — | 80-101 120-141 | 8000-8177 | — | — | 0-127 | 8000.0-8199.15 |

The valid device range depends on the SmartAXIS type. For details, see "Device Addresses" on page 3-1.

Note: For restrictions on ladder programming of SET and RST instructions, see "Restriction on Ladder Programming" on page 5-31.

AND and ANDN (And Not)

The AND instruction is used for programming a NO contact in a series. The ANDN instruction is used for programming a NC contact in a series. The AND or ANDN instruction is entered after the first set of contacts.

Ladder Diagram

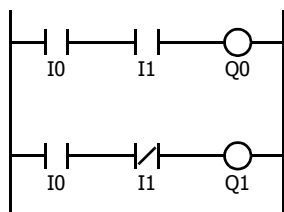

Program List

| Instruction | Data |
|-------------|------|
| LOD | I0 |
| AND | I1 |
| OUT | Q0 |
| LOD | I0 |
| ANDN | I1 |
| OUT | Q1 |

Timing Chart

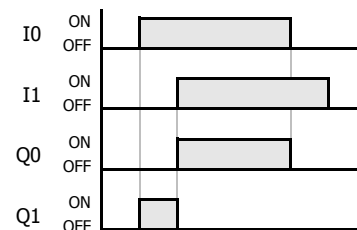

When both inputs I0 and I1 are on, output Q0 is on. When either input I0 or I1 is off, output Q0 is off.
 When input I0 is on and input I1 is off, output Q1 is on. When either input I0 is off or input I1 is on, output Q1 is off.

Valid Devices

| Instruction | I | Q | M | T | C | R | D |
|-------------|-------------------|-------------------|-----------|-------|-------|-------|----------------|
| AND | 0-35 40-75 | 0-21 40-61 | 0-1277 | 0-199 | 0-199 | 0-127 | 0.0-1999.15 |
| ANDN | 80-115 120-155 | 80-101 120-141 | 8000-8177 | | | | 8000.0-8199.15 |

The valid device range depends on the SmartAXIS type. For details, see "Device Addresses" on page 3-1.
 Data registers can be used as bit devices with the data register number and the bit position separated by a period.

OR and ORN (Or Not)

The OR instruction is used for programming a NO contact in parallel. The ORN instruction is used for programming a NC contact in parallel. The OR or ORN instruction is entered after the first set of contacts.

Ladder Diagram

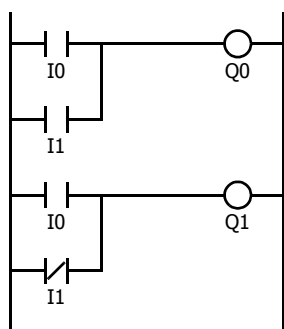

Program List

| Instruction | Data |
|-------------|------|
| LOD | I0 |
| OR | I1 |
| OUT | Q0 |
| LOD | I0 |
| ORN | I1 |
| OUT | Q1 |

Timing Chart

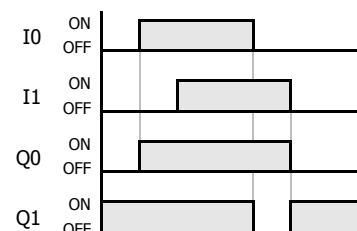

When either input I0 or I1 is on, output Q0 is on. When both inputs I0 and I1 are off, output Q0 is off.
 When either input I0 is on or input I1 is off, output Q1 is on. When input I0 is off and input I1 is on, output Q1 is off.

Valid Devices

| Instruction | I | Q | M | T | C | R | D |
|-------------|-------------------|-------------------|-----------|-------|-------|-------|----------------|
| OR | 0-35 40-75 | 0-21 40-61 | 0-1277 | 0-199 | 0-199 | 0-127 | 0.0-1999.15 |
| ORN | 80-115 120-155 | 80-101 120-141 | 8000-8177 | | | | 8000.0-8199.15 |

The valid device range depends on the SmartAXIS type. For details, see "Device Addresses" on page 3-1.
 Data registers can be used as bit devices with the data register number and the bit position separated by a period.

AND LOD (Load)

The AND LOD instruction is used to connect, in a series, two or more circuits starting with the LOD instruction. The AND LOD instruction is the equivalent of a "node" on a ladder diagram.

When using WindLDR, the user does not need to program the AND LOD instruction. The circuit in the ladder diagram shown below is converted into AND LOD when the ladder diagram is compiled.

Ladder Diagram

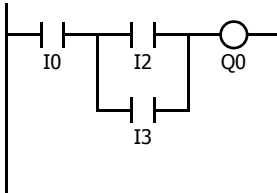

Program List

| Instruction | Data |
|-------------|------|
| LOD | I0 |
| LOD | I2 |
| OR | I3 |
| ANDLOD | |
| OUT | Q0 |

Timing Chart

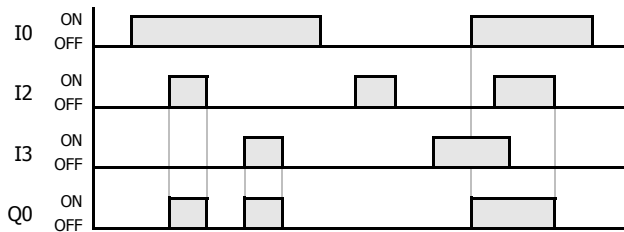

When input I0 is on and either input I2 or I3 is on, output Q0 is on.

When input I0 is off or both inputs I2 and I3 are off, output Q0 is off.

OR LOD (Load)

The OR LOD instruction is used to connect, in parallel, two or more circuits starting with the LOD instruction. The OR LOD instruction is the equivalent of a "node" on a ladder diagram.

When using WindLDR, the user does not need to program the OR LOD instruction. The circuit in the ladder diagram shown below is converted into OR LOD when the ladder diagram is compiled.

Ladder Diagram

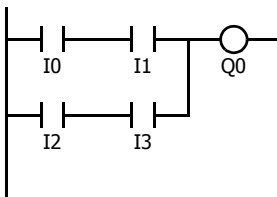

Program List

| Instruction | Data |
|-------------|------|
| LOD | I0 |
| AND | I1 |
| LOD | I2 |
| AND | I3 |
| ORLOD | |
| OUT | Q0 |

Timing Chart

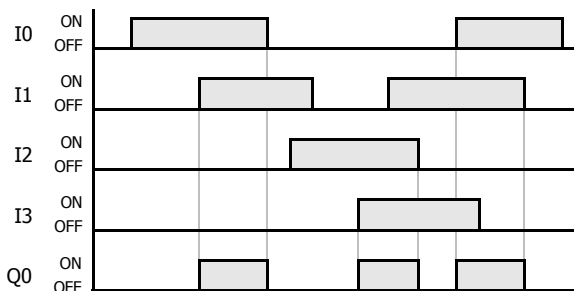

When both inputs I0 and I1 are on or both inputs I2 and I3 are on, output Q0 is on.

When either input I0 or I1 is off and either input I2 or I3 is off, output Q0 is off.

BPS (Bit Push), BRD (Bit Read), and BPP (Bit Pop)

The BPS (bit push) instruction is used to temporarily save the result of bit logical operation.

The BRD (bit read) instruction is used to read the result of the temporarily saved bit logical operation.

The BPP (bit pop) instruction is used to restore the result of the temporarily saved bit logical operation.

When using WindLDR, the user does not need to program the BPS, BRD, and BPP instructions. The circuit in the ladder diagram shown below is converted into BPS, BRD, and BPP when the ladder diagram is compiled.

Ladder Diagram

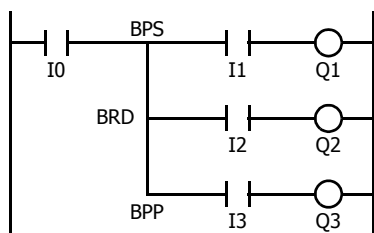

Program List

| Instruction | Data |
|-------------|------|
| LOD | I0 |
| BPS | |
| AND | I1 |
| OUT | Q1 |
| BRD | |
| AND | I2 |
| OUT | Q2 |
| BPP | |
| AND | I3 |
| OUT | Q3 |

Timing Chart

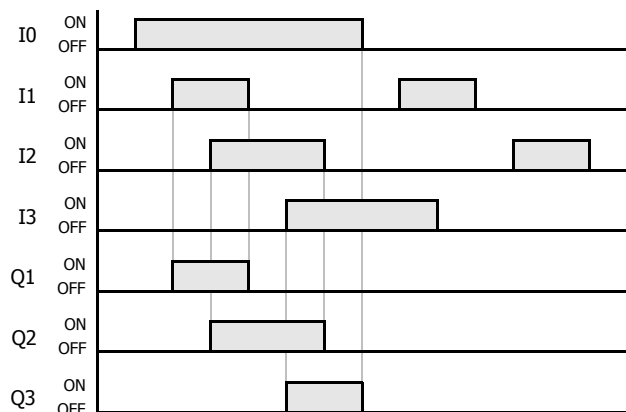

When both inputs I0 and I1 are on, output Q1 is turned on.

When both inputs I0 and I2 are on, output Q2 is turned on.

When both inputs I0 and I3 are on, output Q3 is turned on.

TML, TIM, TMH, and TMS (Timer)

Four types of on-delay timers are available; 1-sec timer TML, 100-ms timer TIM, 10-ms timer TMH, and 1-ms timer TMS. A total of 100 (FT1A-12) or 200 (other SmartAXIS) on- and off-delay timers can be programmed in a user program. Each timer must be allocated to a unique number T0 through T199.

| Timer | Device Address | Range | Increments | Presets Value |
|---------------------------|----------------|-----------------|------------|-----------------------------|
| TML (1-sec timer) | T0 to T199 | 0 to 65535 sec | 1 sec | Constant: 0 to 65535 |
| TIM (100-ms timer) | T0 to T199 | 0 to 6553.5 sec | 100 ms | Data registers: D0 to D1999 |
| TMH (10-ms timer) | T0 to T199 | 0 to 655.35 sec | 10 ms | |
| TMS (1-ms timer) | T0 to T199 | 0 to 65.535 sec | 1 ms | |

The valid device range depends on the SmartAXIS type. For details, see "Device Addresses" on page 3-1.

The preset value can be 0 through 65535 and designated using a decimal constant or data register.

TML (1-sec Timer)

Ladder Diagram (TML)

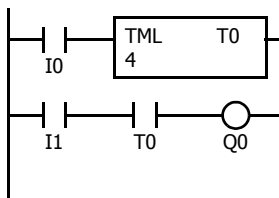

Program List

| Instruction | Data |
|-------------|---------|
| LOD | I0 |
| TML | T0 4 |
| LOD | I1 |
| AND | T0 |
| OUT | Q0 |

Timing Chart

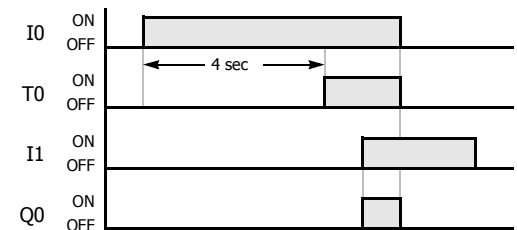

TIM (100-ms Timer)

Ladder Diagram (TIM)

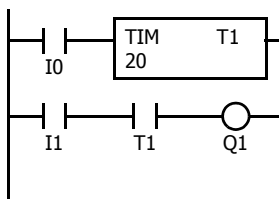

Program List

| Instruction | Data |
|-------------|----------|
| LOD | I0 |
| TIM | T1 20 |
| LOD | I1 |
| AND | T1 |
| OUT | Q1 |

Timing Chart

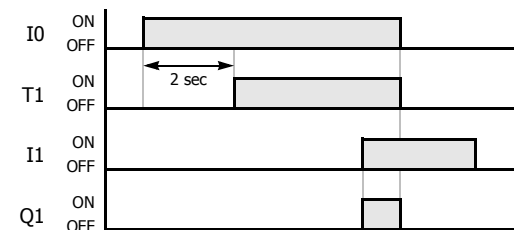

TMH (10-ms Timer)

Ladder Diagram (TMH)

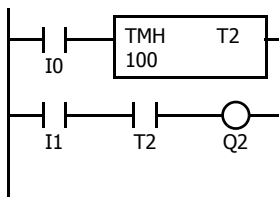

Program List

| Instruction | Data |
|-------------|-----------|
| LOD | I0 |
| TMH | T2 100 |
| LOD | I1 |
| AND | T2 |
| OUT | Q2 |

Timing Chart

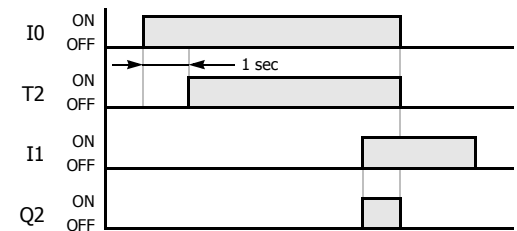

TMS (1-ms Timer)

Ladder Diagram (TMS)

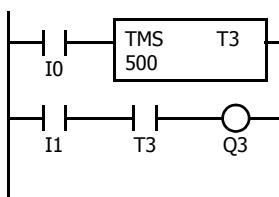

Program List

| Instruction | Data |
|-------------|-----------|
| LOD | I0 |
| TMS | T3 500 |
| LOD | I1 |
| AND | T3 |
| OUT | Q3 |

Timing Chart

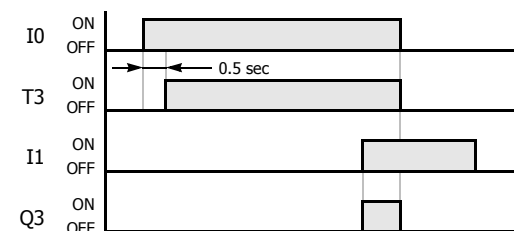

Timer Circuit

The preset value 0 through 65535 can be designated using a data register D0 through D999 or D1000 through D1999; then the data of the data register becomes the preset value. Directly after the TML, TIM, TMH, or TMS instruction, the OUT, OUTN, SET, RST, TML, TIM, TMH, TMS, TMLO, TIMO, TMHO, or TMSO instruction can be programmed.

Ladder Diagram

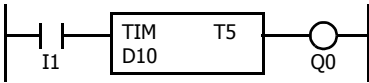

Program List

| Instruction | Data |
|-------------|-----------|
| LOD | I1 |
| TIM | T5 D10 |
| OUT | Q0 |

Note: For restrictions on ladder programming of timer instructions, see "Restriction on Ladder Programming" on page 5-31.

- Countdown from the preset value is initiated when the operation result directly before the timer input is on.
- The timer output turns on when the current value (timed value) reaches 0.
- The current value returns to the preset value when the timer input is off.
- Timer preset and current values can be changed using WindLDR without downloading the entire program to the CPU again. From the WindLDR menu bar, select **Online > Monitor > Monitor**, then **Online > Custom > New Custom Monitor**.
- If a timer preset value is changed during countdown, the timer remains unchanged for that cycle. The change will be reflected in the next time cycle.
- If a timer preset value is changed to 0, then the timer stops operation, and the timer output is turned on immediately.
- If a current value is changed during countdown, the change becomes effective immediately.
- For data movement when changing, confirming, and clearing preset values, see "Changing, Confirming, and Clearing Preset Values for Timers and Counters" on page 5-17. Preset values can also be changed and confirmed using the LCD screen and pushbuttons.
- WindLDR ladder diagrams show TP (timer preset value) and TC (timer current value) in advanced instruction devices.
- The timer instructions (TML, TIM, TMH, TMS) and off-delay timer instructions (TMLO, TIMO, TMHO, TMSO) cannot be used in an interrupt program.
- If used, a user program execution error will result, turning on special internal relay M8004 and the ERR LED on the SmartAXIS. For details about the user program execution errors, see "User Program Execution Errors" on page 4-13.

Timer Accuracy

Timer accuracy due to software configuration depends on three factors: timer input error, timer counting error, and timeout output error. These errors are not constant but vary with the user program and other causes.

Timer Input Error

The input status is read at the END processing and stored to the input RAM. So, an error occurs depending on the timing when the timer input turns on in a scan cycle. The same error occurs on normal input and catch input. The timer input error shown below does not include input delay caused by the hardware.

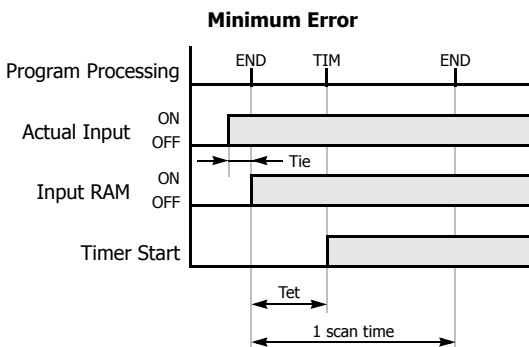

When the input turns on immediately before END processing, Tie is almost 0. Then the timer input error is only Tet (behind error) and is at its minimum.

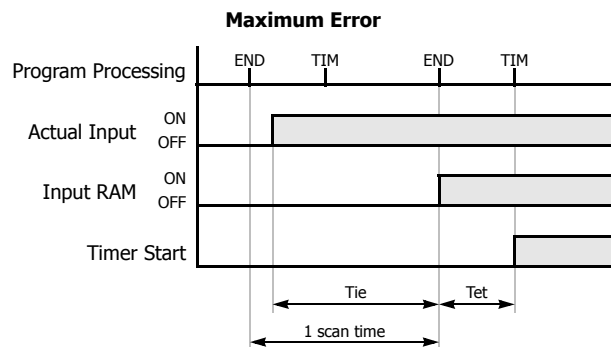

When the input turns on immediately after END processing, Tie is almost equal to one scan time. Then the timer input error is Tie + Tet = one scan time + Tet (behind error) and is at its maximum.

Tie: Time from input turning on to END processing
 Tet: Time from END processing to the timer instruction execution

Timer Counting Error

Every timer instruction operation is individually based on asynchronous 16-bit reference timers. Therefore, an error can occur depending on the status of the asynchronous 16-bit timer when the timer instruction is executed. Use of a TMS (1-ms timer) is recommended to reduce advance errors.

| Error | | TML (1-sec timer) | TIM (100-ms timer) | TMH (10-ms timer) | TMS (1-ms timer) |
|---------|---------------|----------------------|-----------------------|----------------------|---------------------|
| Maximum | Advance error | 1000 ms | 100 ms | 10 ms | 1 ms |
| | Behind error | 1 scan time | 1 scan time | 1 scan time | 1 scan time |

Timeout Output Error

The output RAM status is set to the actual output when the END instruction is processed. When timeout output turns from off to on, an error occurs depending on the position where the timer instruction is programmed in the user program. The timeout output error shown below does not include output delay caused by the hardware.

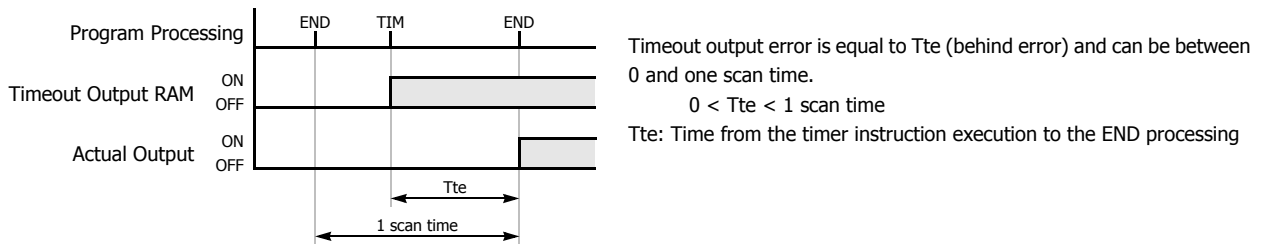

Error Maximum and Minimum

| Error | | Timer Input Error | Timer Counting Error | Timeout Output Error | Total Error |
|---------|---------------|---------------------------------|----------------------|----------------------|----------------------------|
| Minimum | Advance error | 0 (Note) | 0 | 0 (Note) | 0 |
| | Behind error | Tet | 0 | Tte | 0 |
| Maximum | Advance error | 0 (Note) | Increment | 0 (Note) | Increment - (Tet + Tte) |
| | Behind error | 1 scan time + Tet (1 scan time) | 1 scan time | Tte (1 scan time) | 2 scan times + (Tet + Tte) |

- Notes:** Advance error does not occur at the timer input and timeout output.
 Tet + Tte = 1 scan time
 Increment is 1 sec (TML), 100 ms (TIM), 10 ms (TMH), or 1 ms (TMS).
 The maximum advance error is: Increment - 1 scan time
 The maximum behind error is: 3 scan times
 The timer input error and timeout output error shown above do not include the input response time (behind error) and output response time (behind error) caused by hardware.

Power Failure Memory Protection

Timers TML, TIM, TMH, and TMS do not have power failure protection. To provide a timer with this protection use a counter instruction and special internal relay M8121 (1-sec clock), M8122 (100-ms clock), or M8123 (10-ms clock).

**Ladder Diagram
(10-sec Timer)**

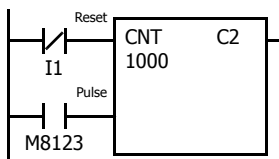

Program List

| Instruction | Data |
|-------------|------------|
| LODN | I1 |
| LOD | M8123 |
| CNT | C2 1000 |

Timing Chart

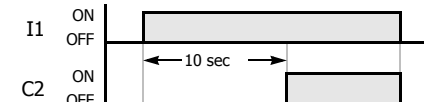

Note: Designate counter C2 used in this program as a keep type counter. See Chapter 5 "Special Functions" - "Keep Designation for Internal Relays, Shift Registers, Counters, and Data Registers" in the SmartAXIS Pro/Lite User's Manual.

TMLO, TIMO, TMHO, and TMSO (Off-Delay Timer)

Four types of on-delay off-delay timers are available; 1-sec off-delay timer TMLO, 100-ms off-delay timer TIMO, 10-ms off-delay timer TMHO, and 1-ms off-delay timer TMSO. A total of 100 (FT1A-12) or 200 (other SmartAXIS) on- and off-delay timers can be programmed in a user program. Each timer must be allocated to a unique number T0 through T199.

| Timer | Device Address | Range | Increments | Presets Value |
|--------------------------------------|----------------|-----------------|------------|-----------------------------|
| TMLO (1-sec off-delay timer) | T0 to T199 | 0 to 65535 sec | 1 sec | Constant: 0 to 65535 |
| TIMO (100-ms off-delay timer) | T0 to T199 | 0 to 6553.5 sec | 100 ms | Data registers: D0 to D1999 |
| TMHO (10-ms off-delay timer) | T0 to T199 | 0 to 655.35 sec | 10 ms | |
| TMSO (1-ms off-delay timer) | T0 to T199 | 0 to 65.535 sec | 1 ms | |

The valid device range depends on the SmartAXIS type. For details, see "Device Addresses" on page 3-1.

The preset value can be 0 through 65535 and designated using a constant or a data register.

TMLO (1-sec Off-delay Timer)

Ladder Diagram (TMLO)

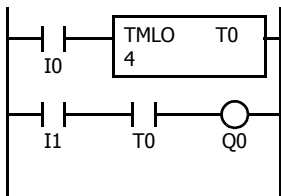

Program List

| Instruction | Data |
|-------------|------|
| LOD | I0 |
| TMLO | T0 |
| | 4 |
| LOD | I1 |
| AND | T0 |
| OUT | Q0 |

Timing Chart

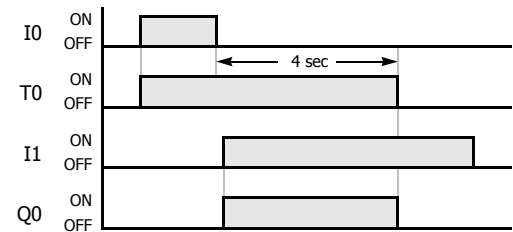

TIMO (100-ms Off-delay Timer)

Ladder Diagram (TIMO)

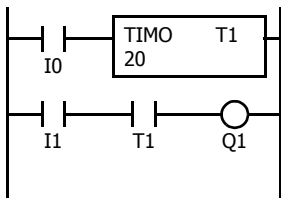

Program List

| Instruction | Data |
|-------------|------|
| LOD | I0 |
| TIMO | T1 |
| | 20 |
| LOD | I1 |
| AND | T1 |
| OUT | Q1 |

Timing Chart

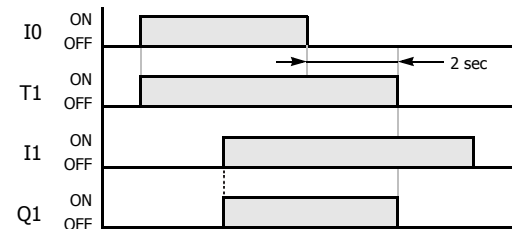

TMHO (10-ms Off-delay Timer)

Ladder Diagram (TMHO)

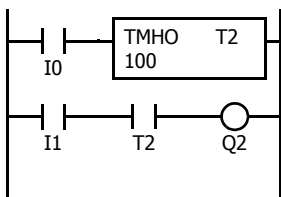

Program List

| Instruction | Data |
|-------------|------|
| LOD | I0 |
| TMHO | T2 |
| | 100 |
| LOD | I1 |
| AND | T2 |
| OUT | Q2 |

Timing Chart

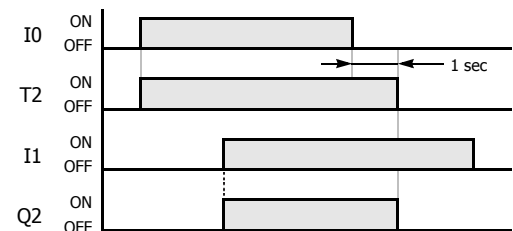

TMSO (1-ms Off-delay Timer)

Ladder Diagram (TMSO)

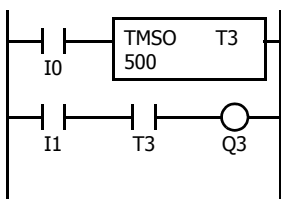

Program List

| Instruction | Data |
|-------------|------|
| LOD | I0 |
| TMSO | T3 |
| | 500 |
| LOD | I1 |
| AND | T3 |
| OUT | Q3 |

Timing Chart

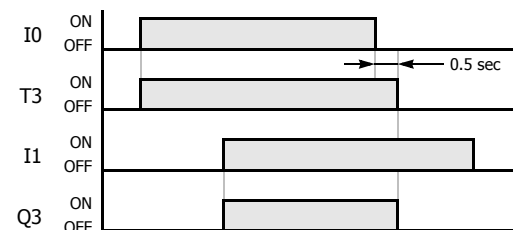

CNT, CDP, and CUD (Counter)

Three types of counters are available; adding (up) counter CNT, dual-pulse reversible counter CDP, and up/down selection reversible counter CUD. A total of 100 (FT1A-12) or 200 (other SmartAXIS) counters can be programmed in a user program. Each counter must be allocated to a unique number C0 through C199.

| Counter | Device Address | Preset Value |
|---|----------------|-----------------------------|
| CNT (adding counter) | C0 to C199 | Constant: 0 to 65535 |
| CDP (dual-pulse reversible counter) | C0 to C199 | Data registers: D0 to D1999 |
| CUD (up/down selection reversible counter) | C0 to C199 | |

The valid device range depends on the SmartAXIS type. For details, see "Device Addresses" on page 3-1.

The preset value can be 0 through 65535 and designated using a decimal constant or data register.

CNT (Adding Counter)

When counter instructions are programmed, two addresses are required. The circuit for an adding (UP) counter must be programmed in the following order: reset input, pulse input, the CNT instruction, and a counter number C0 through C199, followed by a counter preset value from 0 to 65535.

The preset value can be designated using a decimal constant or a data register. When a data register is used, the data of the data register becomes the preset value.

Ladder Diagram

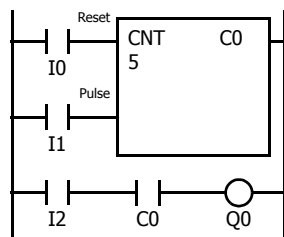

Program List

| Instruction | Data |
|-------------|------|
| LOD | I0 |
| LOD | I1 |
| CNT | C0 |
| | 5 |
| LOD | I2 |
| AND | C0 |
| OUT | Q0 |

Timing Chart

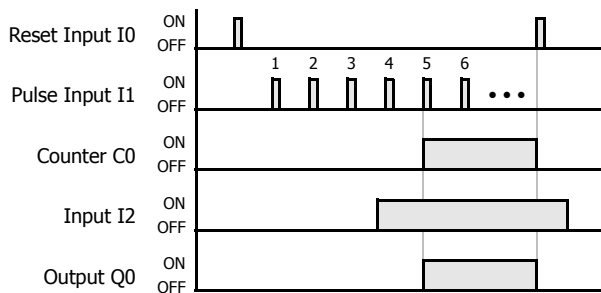

- The preset value 0 through 65535 can be designated using a data register D0 through D1999; then the data of the data register becomes the preset value.
- Directly after the CNT instruction, the OUT, OUTN, SET, RST, TML, TIM, TMH, or TMS instruction can be programmed.

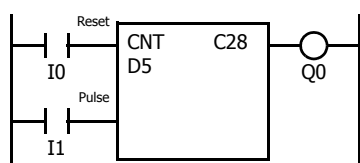

- A single counter number cannot be programmed more than once.
- While the reset input is off, the counter counts the leading edges of pulse inputs and compares them with the preset value.
- When the current value reaches the preset value, the counter turns output on. The output stays on until the reset input is turned on.
- When the reset input changes from off to on, the current value is reset.
- When the reset input is on, all pulse inputs are ignored.
- The reset input must be turned off before counting may begin.
- When power is off, the counter's current value is held, and can also be designated as "clear" type counters using Function Area Settings (see Chapter 5 "Special Functions" - "Keep Designation for Internal Relays, Shift Registers, Counters, and Data Registers" in the SmartAXIS Pro/Lite User's Manual.).
- Counter preset and current values can be changed using WindLDR without downloading the entire program to the CPU again. From the WindLDR menu bar, select **Online > Monitor > Monitor**, then **Online > Custom > New Custom Monitor**. Change the current value while the counter reset input is off.
- When the preset or current value is changed during counter operation, the change becomes effective immediately.
- When power is off, the preset values that were changed are cleared and the original preset values are loaded.
- For data movement when changing, confirming, and clearing preset values, see "Changing, Confirming, and Clearing Preset Values for Timers and Counters" on page 5-17. Preset values can also be changed and confirmed using the LCD screen and pushbuttons.
- WindLDR ladder diagrams show CP (counter preset value) and CC (counter current value) in advanced instruction devices.
- The CNT instruction cannot be used in an interrupt program. If used, a user program execution error will result, turning on special internal relay M8004 and the ERR LED on the SmartAXIS. For details about the user program execution errors, see "User Program Execution Errors" on page 4-13.

CDP (Dual-Pulse Reversible Counter)

The dual-pulse reversible counter CDP has up and down pulse inputs, so the three inputs are required. The circuit for a dual-pulse reversible counter must be programmed in the following order: preset input, up-pulse input, down-pulse input, the CDP instruction, and a counter number C0 through C199, followed by a counter preset value from 0 to 65535.

The preset value can be designated using a decimal constant or a data register. When a data register is used, the data of the data register becomes the preset value.

Ladder Diagram

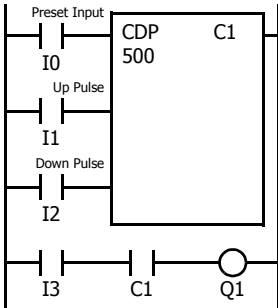

Program List

| Instruction | Data |
|-------------|------|
| LOD | I0 |
| LOD | I1 |
| LOD | I2 |
| CDP | C1 |
| | 500 |
| LOD | I3 |
| AND | C1 |
| OUT | Q1 |

- A single counter number cannot be programmed more than once.
- The preset input must be turned on initially so that the current value returns to the preset value.
- The preset input must be turned off before counting may begin.
- When the up pulse and down pulses are on simultaneously, no pulse is counted.
- The counter output is on only when the current value is 0.
- After the current value reaches 0 (counting down), it changes to 65535 on the next count down.
- After the current value reaches 65535 (counting up), it changes to 0 on the next up count.
- When power is off, the counter's current value is held, and can also be designated as "clear" type counters using the Function Area Settings (see Chapter 5 "Special Functions" - "Keep Designation for Internal Relays, Shift Registers, Counters, and Data Registers" in the SmartAXIS Pro/Lite User's Manual.).
- Counter preset and current values can be changed using WindLDR without downloading the entire program to the CPU again. From the WindLDR menu bar, select **Online > Monitor > Monitor**, then **Online > Custom > New Custom Monitor**. Change the current value while the counter preset input is off.
- When the preset or current value is changed during counter operation, the change becomes effective immediately.
- When power is off, the changed preset values are cleared and the original preset values are loaded.
- For data movement when changing, confirming, and clearing preset values, see "Changing, Confirming, and Clearing Preset Values for Timers and Counters" on page 5-17. Preset values can also be changed and confirmed using the LCD screen and pushbuttons.
- WindLDR ladder diagrams show CP (counter preset value) and CC (counter current value) in advanced instruction devices. The CDP instruction cannot be used in an interrupt program.
- If used, a user program execution error will result, turning on special internal relay M8004 and the ERR LED on the SmartAXIS. For details about the user program execution errors, see "User Program Execution Errors" on page 4-13.

Timing Chart

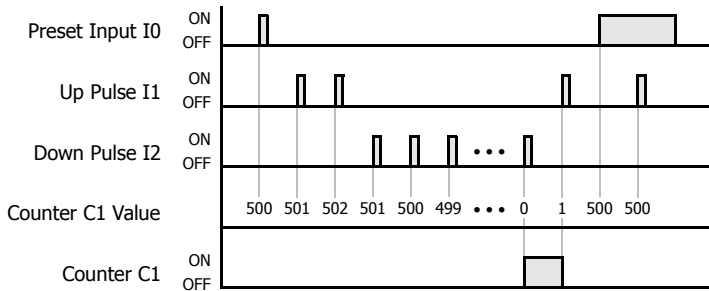

Note: For restrictions on ladder programming of counter instructions, see "Restriction on Ladder Programming" on page 5-31.

Counter Operation after Count out

| Condition | Counter Output |
|---|--|
| When the counter has counted out, either the current value or preset value is changed. | The counter maintains the counted out status. |
| Before the counter has counted out, the current value is changed to a larger value than the preset. | The counter output is turned on. |
| The preset value is changed to 0. | The counter output is turned on without regard to the current value. |
| When the reset input is on, the preset value is changed to 0. | The counter output is not turned on. |

CUD (Up/Down Selection Reversible Counter)

The up/down selection reversible counter CUD has a selection input to switch the up/down gate, so the three inputs are required. The circuit for an up/down selection reversible counter must be programmed in the following order: preset input, pulse input, up/down selection input, the CUD instruction, and a counter number C0 through C199, followed by a counter preset value from 0 to 65535.

The preset value can be designated using a decimal constant or a data register. When a data register is used, the data of the data register becomes the preset value.

Ladder Diagram

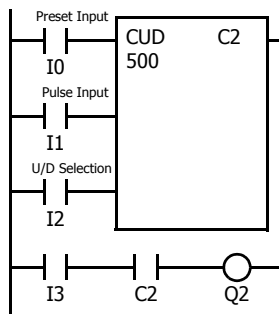

Program List

| Instruction | Data |
|-------------|------|
| LOD | I0 |
| LOD | I1 |
| LOD | I2 |
| CUD | C2 |
| | 500 |
| LOD | I3 |
| AND | C2 |
| OUT | Q2 |

Timing Chart

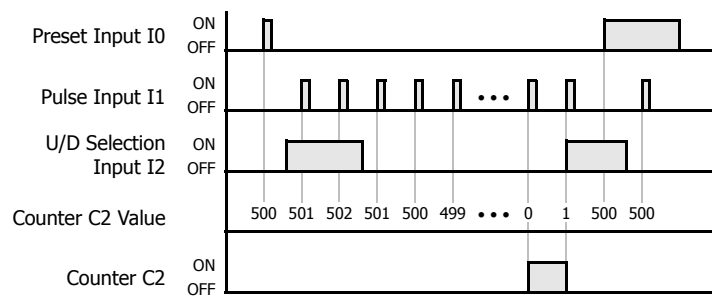

Valid Pulse Inputs

The reset or preset input has priority over the pulse input. One scan after the reset or preset input has changed from on to off, and the counter starts counting the pulse inputs as they change from off to on.

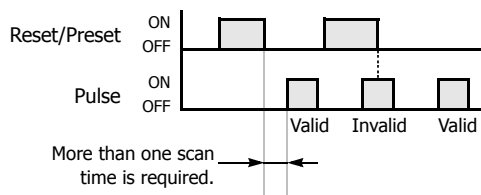

- A single counter number cannot be programmed more than once.
- The preset input must be turned on initially so that the current value returns to the preset value.
- The preset input must be turned off before counting may begin.
- The up mode is selected when the up/down selection input is on.
- The down mode is selected when the up/down selection input is off.
- The counter output is on only when the current value is 0.
- After the current value reaches 0 (counting down), it changes to 65535 on the next count down.
- After the current value reaches 65535 (counting up), it changes to 0 on the next count up.
- When power is off, the counter's current value is held, and can also be designated as "clear" type counters using the Function Area Settings (see Chapter 5 "Special Functions" - "Keep Designation for Internal Relays, Shift Registers, Counters, and Data Registers" in the SmartAXIS Pro/Lite User's Manual.).
- Counter preset and current values can be changed using WindLDR without downloading the entire program to the CPU again. From the WindLDR menu bar, select **Online > Monitor > Monitor**, then **Online > Custom > New Custom Monitor**. Change the current value while the counter preset input is off.
- When the preset or current value is changed during counter operation, the change becomes effective immediately.
- When power is off, the changed preset values are cleared and the original preset values are loaded.
- For data movement when changing, confirming, and clearing preset values, see "Changing, Confirming, and Clearing Preset Values for Timers and Counters" on page 5-17. Preset values can also be changed and confirmed using the LCD screen and pushbuttons.
- WindLDR ladder diagrams show CP (counter preset value) and CC (counter current value) in advanced instruction devices. The CUD instruction cannot be used in an interrupt program.
- If used, a user program execution error will result, turning on special internal relay M8004 and the ERR LED on the SmartAXIS. For details about the user program execution errors, see "User Program Execution Errors" on page 4-13.

Note: For restrictions on ladder programming of counter instructions, see "Restriction on Ladder Programming" on page 5-31.

CNTD, CDPD, and CUDD (Double-Word Counter)

Three types of double-word counters are available; adding (up) counter CNTD, dual-pulse reversible counter CDPD, and up/down selection reversible counter CUDD. A total of 50 (FT1A-12) or 100 (other SmartAXIS) double-word counters can be programmed in a user program. Each double-word counter uses 2 consecutive devices starting with the allocated device, which can be C0 through C198. Once used in a user program, counters cannot be used in any other counter instructions.

| Counter | Device Address | Preset Value |
|--|----------------|--|
| CNTD (double-word adding counter) | C0 to C198 | Constant: 0 to 4,294,967,295 |
| CDPD (double-word dual-pulse reversible counter) | C0 to C198 | Data registers: D0 to D998 D1000 to D1998 |
| CUDD (double-word up/down selection reversible counter) | C0 to C198 | |

The valid device range depends on the SmartAXIS type. For details, see "Device Addresses" on page 3-1.

The preset value can be 0 through 4,294,967,295 and designated using a constant or a data register. If a data register is designated as the preset value, two consecutive data registers are used.

CNTD (Double-Word Adding Counter)

When double-word adding counter instructions are programmed, two addresses are required. The circuit for a double-word adding (UP) counter must be programmed in the following order: reset input, pulse input, the CNTD instruction, and a counter number C0 through C198, followed by a counter preset value from 0 to 4,294,967,295.

The preset value can be designated using a constant or a data register. When a data register is used, the double-word data of two consecutive data registers becomes the preset value. For 32-bit data storage setting, see Chapter 5 "Special Functions" - "32-bit Data Storage Setting" in the SmartAXIS Pro/Lite User's Manual.

Ladder Diagram

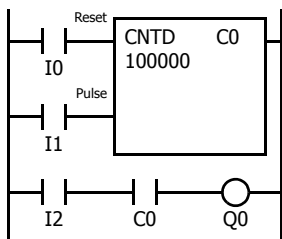

Program List

| Instruction | Data |
|-------------|--------|
| LOD | I0 |
| LOD | I1 |
| CNTD | C0 |
| | 100000 |
| LOD | I2 |
| AND | C0 |
| OUT | Q0 |

Timing Chart

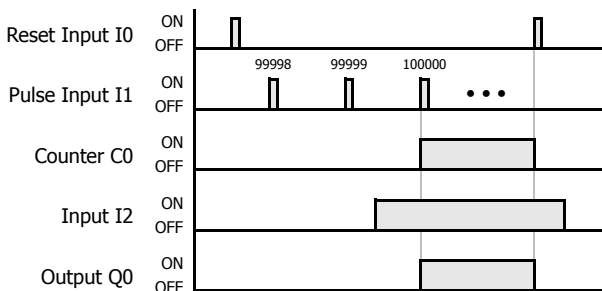

- The preset value 0 through 4,294,967,295 can be designated using a data register D0 through D1998; then the data of the data registers becomes the preset value.
- Directly after the CNTD instruction, the OUT, OUTN, SET, RST, TML, TIM, TMH, TMS, TML0, TIMO, TMHO, or TMSO instruction can be programmed.

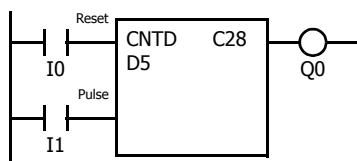

- Double-word counter instructions use two consecutive counters, and counters cannot be used more than once in a user program.
- While the reset input is off, the counter counts the leading edges of pulse inputs and compares them with the preset value.
- When the current value reaches the preset value, the counter turns output on. The output stays on until the reset input is turned on.
- When the reset input changes from off to on, the current value is reset.
- When the reset input is on, all pulse inputs are ignored.
- The reset input must be turned off before counting may begin.
- When power is off, the counter's current value is held, and can also be designated as "clear" type counters using Function Area Settings (see Chapter 5 "Special Functions" - "Keep Designation for Internal Relays, Shift Registers, Counters, and Data Registers" in the SmartAXIS Pro/Lite User's Manual.).
- Counter preset and current values can be changed using WindLDR without downloading the entire program to the CPU again. From the WindLDR menu bar, select **Online > Monitor > Monitor**, then **Online > Custom > New Custom Monitor**. To change a counter preset value, select DEC(D) in the pull-down list box.
- When the preset or current value is changed during counter operation, the change becomes effective immediately.
- When power is off, the changed preset values are cleared and the original preset values are loaded.
- For data movement when changing, confirming, and clearing preset values, see "Changing, Confirming, and Clearing Preset Values for Timers and Counters" on page 5-17.
- WindLDR ladder diagrams show CP (counter preset value) and CC (counter current value) in advanced instruction devices.
- The CNTD instruction cannot be used in an interrupt program.
- If used, a user program execution error will result, turning on special internal relay M8004 and the ERR LED on the SmartAXIS. For details about the user program execution errors, see "User Program Execution Errors" on page 4-13.

CDPD (Double-Word Dual-Pulse Reversible Counter)

The double-word dual-pulse reversible counter CDPD has up and down pulse inputs, so the three inputs are required. The circuit for a double-word dual-pulse reversible counter must be programmed in the following order: preset input, up-pulse input, down-pulse input, the CDPD instruction, and a counter number C0 through C198, followed by a counter preset value from 0 to 4,294,967,295.

The preset value can be designated using a constant or a data register. When a data register is used, the double-word data of two consecutive data registers becomes the preset value. For 32-bit data storage setting, see Chapter 5 "Special Functions" - "32-bit Data Storage Setting" in the SmartAXIS Pro/Lite User's Manual.

Ladder Diagram

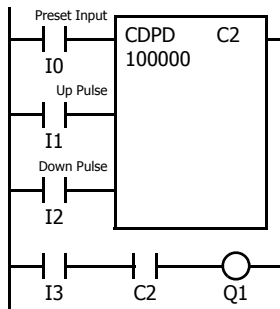

Program List

| Instruction | Data |
|-------------|--------|
| LOD | I0 |
| LOD | I1 |
| LOD | I2 |
| CDPD | C2 |
| | 100000 |
| LOD | I3 |
| AND | C2 |
| OUT | Q1 |

Timing Chart

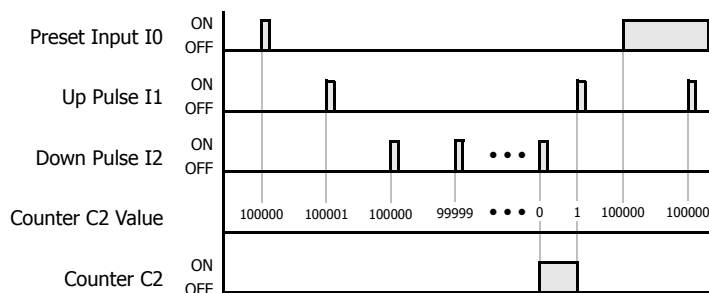

- Double-word counter instructions use two consecutive counters, and counters cannot be used more than once in a user program.
- The preset input must be turned on initially so that the current value returns to the preset value.
- The preset input must be turned off before counting may begin.
- When the up and down pulses are on simultaneously, no pulse is counted.
- The counter output is on only when the current value is 0.
- After the current value reaches 0 (counting down), it changes to 4,294,967,295 on the next count down.
- After the current value reaches 4,294,967,295 (counting up), it changes to 0 on the next count up.
- When power is off, the counter's current value is held, and can also be designated as "clear" type counters using the Function Area Settings (see Chapter 5 "Special Functions" - "Keep Designation for Internal Relays, Shift Registers, Counters, and Data Registers" in the SmartAXIS Pro/Lite User's Manual.).
- Counter preset and current values can be changed using WindLDR without downloading the entire program to the CPU again. From the WindLDR menu bar, select **Online > Monitor > Monitor**, then **Online > Custom > New Custom Monitor**. To change a counter preset value, select DEC(D) in the pull-down list box.
- When the preset or current value is changed during counter operation, the change becomes effective immediately.
- When power is off, the changed preset values are cleared and the original preset values are loaded.
- For data movement when changing, confirming, and clearing preset values, see "Changing, Confirming, and Clearing Preset Values for Timers and Counters" on page 5-17.
- WindLDR ladder diagrams show CP (counter preset value) and CC (counter current value) in advanced instruction devices. The CNPD instruction cannot be used in an interrupt program.
- If used, a user program execution error will result, turning on special internal relay M8004 and the ERR LED on the SmartAXIS. For details about the user program execution errors, see "User Program Execution Errors" on page 4-13.

CUDD (Double-Word Up/Down Selection Reversible Counter)

The double-word up/down selection reversible counter CUDD has a selection input to switch the up/down gate, so the three inputs are required. The circuit for a double-word up/down selection reversible counter must be programmed in the following order: preset input, pulse input, up/down selection input, the CUDD instruction, and a counter number C0 through C198, followed by a counter preset value from 0 to 4,294,967,295.

The preset value can be designated using a constant or a data register. When a data register is used, the double-word data of two consecutive data registers becomes the preset value. For 32-bit data storage setting, see Chapter 5 "Special Functions" - "32-bit Data Storage Setting" in the SmartAXIS Pro/Lite User's Manual.

Ladder Diagram

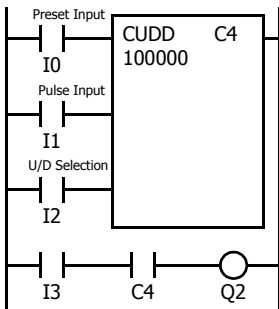

Program List

| Instruction | Data |
|-------------|--------|
| LOD | I0 |
| LOD | I1 |
| LOD | I2 |
| CUDD | C4 |
| | 100000 |
| LOD | I3 |
| AND | C4 |
| OUT | Q2 |

Timing Chart

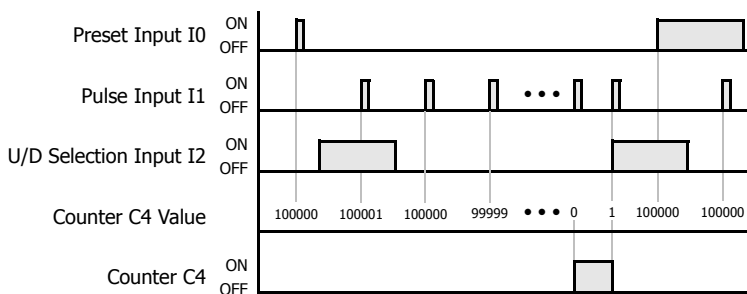

Valid Pulse Inputs

The reset or preset input has priority over the pulse input. One scan after the reset or preset input has changed from on to off, the counter starts counting the pulse inputs as they change from off to on.

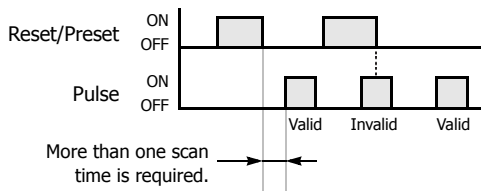

- Double-word counter instructions use two consecutive counters, and counters cannot be used more than once in a user program.
- The preset input must be turned on initially so that the current value returns to the preset value.
- The preset input must be turned off before counting may begin.
- The up mode is selected when the up/down selection input is on.
- The down mode is selected when the up/down selection input is off.
- The counter output is on only when the current value is 0.
- After the current value reaches 0 (counting down), it changes to 4,294,967,295 on the next count down.
- After the current value reaches 4,294,967,295 (counting up), it changes to 0 on the next count up.
- When power is off, the counter's current value is held, and can also be designated as "clear" type counters using the Function Area Settings (see Chapter 5 "Special Functions" - "Keep Designation for Internal Relays, Shift Registers, Counters, and Data Registers" in the SmartAXIS Pro/Lite User's Manual.).
- Counter preset and current values can be changed using WindLDR without downloading the entire program to the CPU again. From the WindLDR menu bar, select **Online > Monitor > Monitor**, then **Online > Custom > New Custom Monitor**. To change a counter preset value, select DEC(D) in the pull-down list box.
- When the preset or current value is changed during counter operation, the change becomes effective immediately.
- When power is off, the changed preset values are cleared and the original preset values are loaded.
- For data movement when changing, confirming, and clearing preset values, see "Changing, Confirming, and Clearing Preset Values for Timers and Counters" on page 5-17.
- WindLDR ladder diagrams show CP (counter preset value) and CC (counter current value) in advanced instruction devices. The CUDD instruction cannot be used in an interrupt program.
- If used, a user program execution error will result, turning on special internal relay M8004 and the ERR LED on the SmartAXIS. For details about the user program execution errors, see "User Program Execution Errors" on page 4-13.

Changing, Confirming, and Clearing Preset Values for Timers and Counters

Preset values for timers and counters can be changed by selecting **Online > Monitor > Monitor**, followed by **Online > Custom > New Custom Monitor** on WindLDR for transferring a new value to the SmartAXIS RAM as described on preceding pages. After changing the preset values temporarily, the changes can be written to the user program in the SmartAXIS ROM or cleared from the RAM.

When the power is off, the temporarily changed preset values in the RAM are cleared and the original preset values are loaded. Confirm the changed preset values to store them in the ROM. The timer/counter preset values can be confirmed only when SmartAXIS is stopped.

To access the PLC Status dialog box from the WindLDR menu bar, select **Online > Monitor > Monitor**, then **Online > Status**.

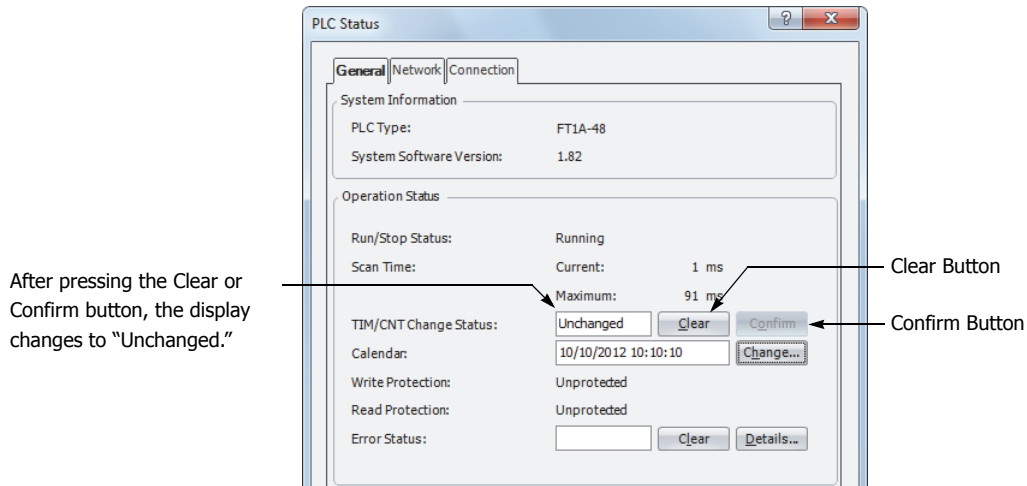

Data movement when changing a timer/counter preset value

When changing a timer/counter preset value using Custom Monitor on WindLDR, the new preset value is written to the SmartAXIS RAM. The user program and preset values in the ROM are not changed.

Note: The LCD screen and pushbuttons can also be used to change preset values and confirm changed preset values.

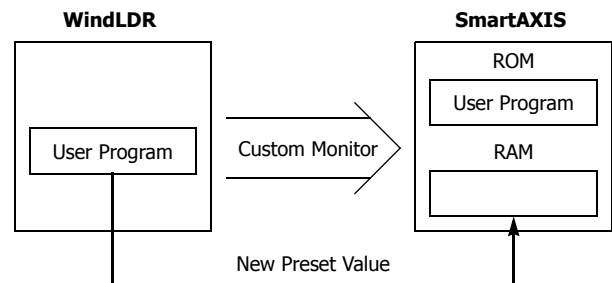

Data movement when confirming changed preset values

When the Confirm button is pressed before pressing the Clear button, the changed timer/counter preset values in the SmartAXIS RAM are written to the ROM.

When uploading the user program after confirming, the user program with changed preset values is uploaded from the SmartAXIS ROM to WindLDR.

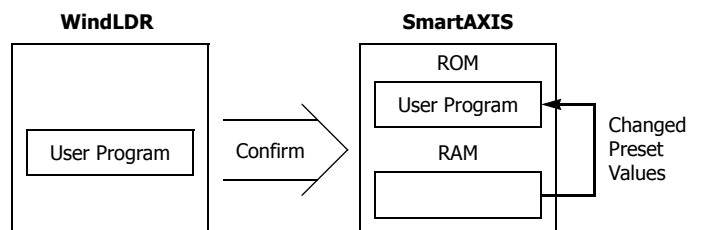

Data movement when clearing changed preset values to restore original values

Changing preset values for timers and counters in the SmartAXIS RAM does not automatically update preset values in the user memory, ROM. This is useful for restoring original preset values. When the Clear button is pressed before pressing the Confirm button, the changed timer/counter preset values are cleared from the RAM and the original preset values are loaded from the ROM to the RAM.

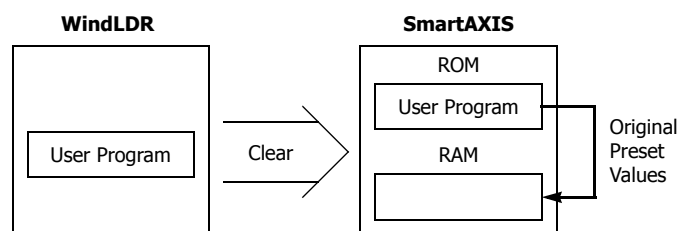

CC= and CC>= (Counter Comparison)

The CC= instruction is an equivalent comparison instruction for counter current values. This instruction will constantly compare current values to the value that has been programmed in. When the counter value equals the given value, the desired output will be initiated.

The CC>= instruction is an equal to or greater than comparison instruction for counter current values. This instruction will constantly compare current values to the value that has been programmed in. When the counter value is equal to or greater than the given value, the desired output will be initiated.

When a counter comparison instruction is programmed, two addresses are required. The circuit for a counter comparison instruction must be programmed in the following order: the CC= or CC>= instruction; a counter number C0 through C199, followed by a preset value to compare from 0 to 65535.

The preset value can be designated using a decimal constant or a data register D0 through D1999. When a data register is used, the data of the data register becomes the preset value.

Ladder Diagram (CC=)

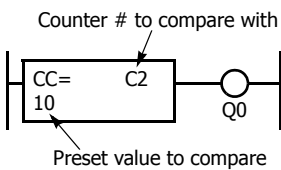

Program List

| Instruction | Data |
|-------------|------|
| CC= | C2 |
| | 10 |
| OUT | Q0 |

Ladder Diagram (CC>=)

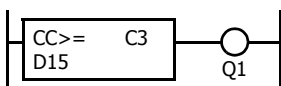

Program List

| Instruction | Data |
|-------------|------|
| CC>= | C3 |
| | D15 |
| OUT | Q1 |

- The CC= and CC>= instructions can be used repeatedly for different preset values.
- The comparison instructions only compare the current value. The status of the counter does not affect this function.
- The comparison instructions also serve as an implicit LOD instruction.
- The comparison instructions can be used with internal relays, which are ANDed or ORed at a separate program address.
- Like the LOD instruction, the comparison instructions can be followed by the AND and OR instructions.

Ladder Diagram

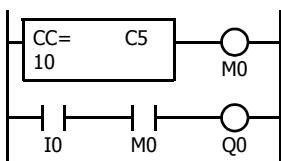

Program List

| Instruction | Data |
|-------------|------|
| CC= | C5 |
| | 10 |
| OUT | M0 |
| LOD | I0 |
| AND | M0 |
| OUT | Q0 |

Ladder Diagram

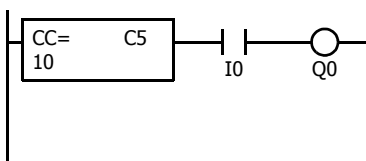

Program List

| Instruction | Data |
|-------------|------|
| CC= | C5 |
| | 10 |
| AND | I0 |
| OUT | Q0 |

Ladder Diagram

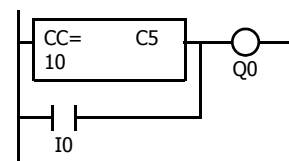

Program List

| Instruction | Data |
|-------------|------|
| CC= | C5 |
| | 10 |
| OR | I0 |
| OUT | Q0 |

Examples: CC= and CC>= (Counter Comparison)

Ladder Diagram 1

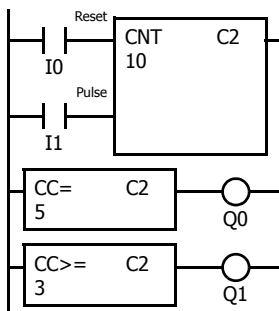

Program List

| Instruction | Data |
|-------------|------|
| LOD | I0 |
| LOD | I1 |
| CNT | C2 |
| | 10 |
| CC= | C2 |
| | 5 |
| OUT | Q0 |
| CC>= | C2 |
| | 3 |
| OUT | Q1 |

Timing Chart

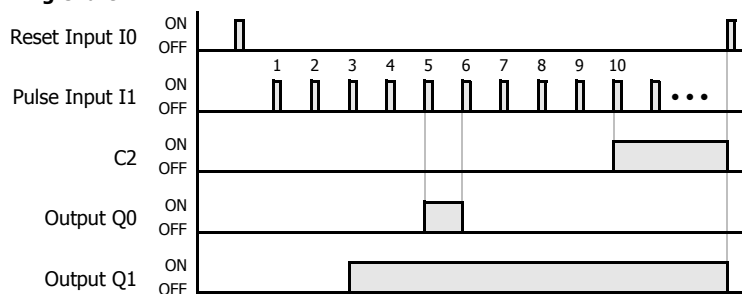

Output Q0 is on when counter C2 current value is 5.
Output Q1 is turned on when counter C2 current value reaches 3 and remains on until counter C2 is reset.

Ladder Diagram 2

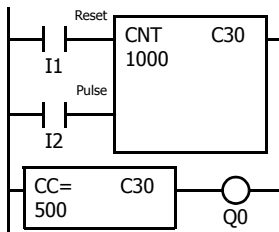

Program List

| Instruction | Data |
|-------------|------|
| LOD | I1 |
| LOD | I2 |
| CNT | C30 |
| | 1000 |
| CC= | C30 |
| | 500 |
| OUT | Q0 |

Timing Chart



Output Q0 is on when counter C30 current value is 500.

Ladder Diagram 3

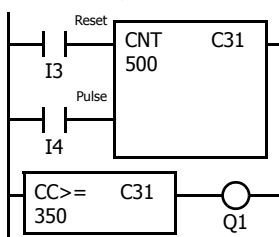

Program List

| Instruction | Data |
|-------------|------|
| LOD | I3 |
| LOD | I4 |
| CNT | C31 |
| | 500 |
| CC>= | C31 |
| | 350 |
| OUT | Q1 |

Timing Chart

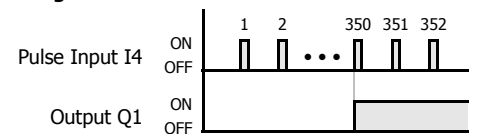

Output Q1 is turned on when counter C31 current value reaches 350 and remains on until counter C31 is reset.

Ladder Diagram 4

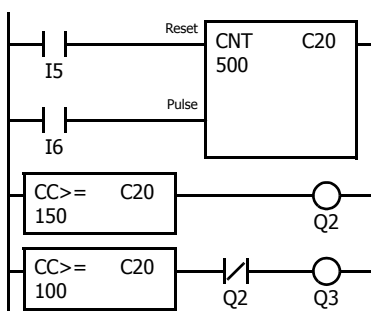

Program List

| Instruction | Data |
|-------------|------|
| LOD | I5 |
| LOD | I6 |
| CNT | C20 |
| | 500 |
| CC>= | C20 |
| | 150 |
| OUT | Q2 |
| CC>= | C20 |
| | 100 |
| ANDN | Q2 |
| OUT | Q3 |

Timing Chart

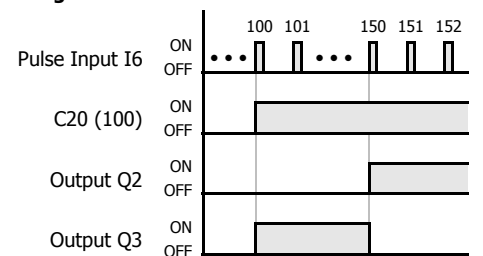

Output Q3 is on when counter C20 current value is between 100 and 149.

DC= and DC>= (Data Register Comparison)

The DC= instruction is an equivalent comparison instruction for data register values. This instruction will constantly compare data register values to the value that has been programmed in. When the data register value equals the given value, the desired output will be initiated.

The DC>= instruction is an equal to or greater than comparison instruction for data register values. This instruction will constantly compare data register values to the value that has been programmed in. When the data register value is equal to or greater than the given value, the desired output will be initiated.

When a data register comparison instruction is programmed, two addresses are required. The circuit for a data register comparison instruction must be programmed in the following order: the DC= or DC>= instruction, a data register number D0 through D1999 followed by a preset value to compare from 0 to 65535.

The preset value can be designated using a decimal constant or a data register D0 through D1999. When a data register is used, the data of the data register becomes the preset value.

For LC (Load Compare) instructions, see "LC= (Load Compare Equal To)" on page 7-8.

Ladder Diagram (DC=)

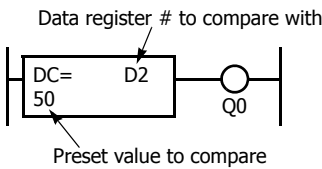

Program List

| Instruction | Data |
|-------------|------|
| DC= | D2 |
| | 50 |
| OUT | Q0 |

Ladder Diagram (DC>=)

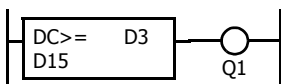

Program List

| Instruction | Data |
|-------------|------|
| DC>= | D3 |
| | D15 |
| OUT | Q1 |

- The DC= and DC>= instructions can be repeated for different preset values.
- The comparison instructions also serve as an implicit LOD instruction.
- The comparison instructions can be used with internal relays, which are ANDed or ORed at a separate program address.
- Like the LOD instruction, the comparison instructions can be followed by the AND and OR instructions.

Ladder Diagram

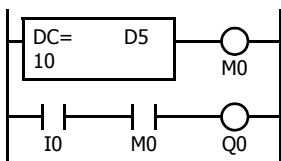

Program List

| Instruction | Data |
|-------------|------|
| DC= | D5 |
| | 10 |
| OUT | M0 |
| LOD | I0 |
| AND | M0 |
| OUT | Q0 |

Ladder Diagram

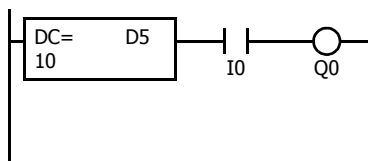

Program List

| Instruction | Data |
|-------------|------|
| DC= | D5 |
| | 10 |
| AND | I0 |
| OUT | Q0 |

Ladder Diagram

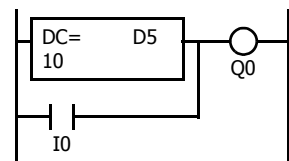

Program List

| Instruction | Data |
|-------------|------|
| DC= | D5 |
| | 10 |
| OR | I0 |
| OUT | Q0 |

Examples: DC= and DC>= (Data Register Comparison)

Ladder Diagram 1

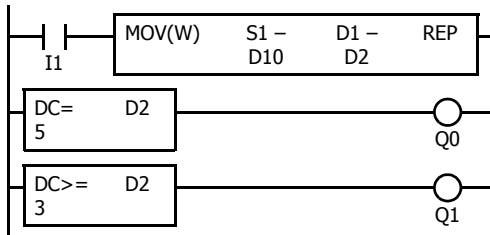

Program List

| Instruction | Data |
|-----------------|---------------|
| LOD | I1 |
| MOV(W) | D10 - D2 - |
| DC= | D2 5 |
| OUT | Q0 |
| DC ³ | D2 3 |
| OUT | Q1 |

Timing Chart

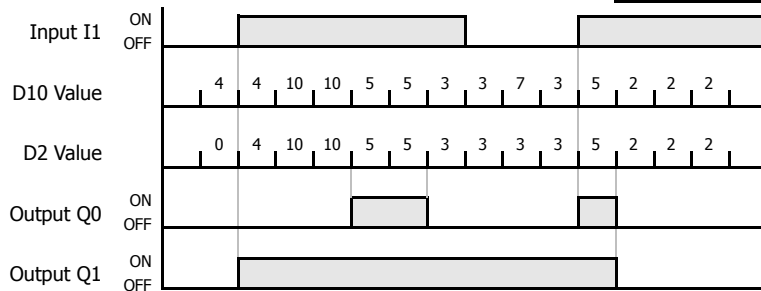

Output Q0 is on when data register D2 value is 5.
Output Q1 is on when data register D2 value is 3 or more.

Ladder Diagram 2

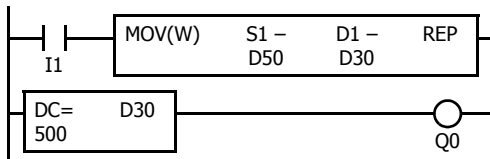

Timing Chart

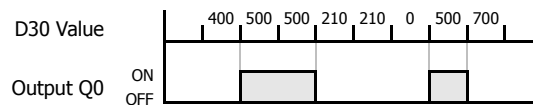

Output Q0 is on when data register D30 value is 500.

Ladder Diagram 3

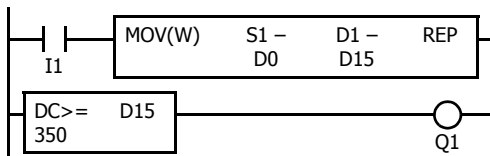

Timing Chart

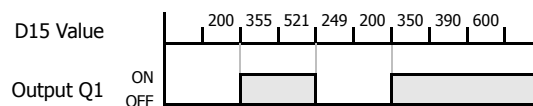

Output Q1 is on when data register D15 value is 350 or more.

Ladder Diagram 4

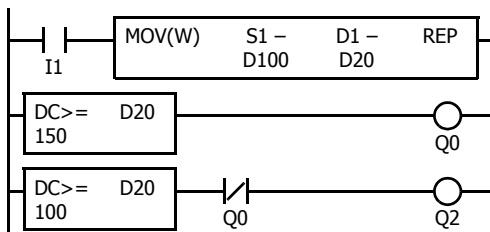

Timing Chart

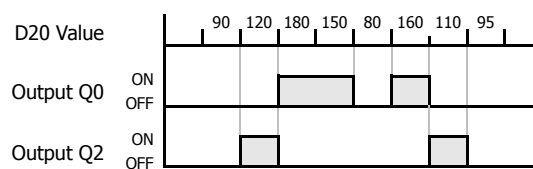

Output Q2 is on while data register D20 value is between 149 and 100.

SFR and SFRN (Forward and Reverse Shift Register)

SmartAXIS have a shift register consisting of 128 bits which are allocated to R0 through R127. Any number of available bits can be selected to form a train of bits which store on or off status. The on/off data of constituent bits is shifted in the forward direction (forward shift register) or in the reverse direction (reverse shift register) when a pulse input is turned on.

Forward Shift Register (SFR)

When SFR instructions are programmed, two addresses are always required. The SFR instruction is entered, followed by a shift register number selected from appropriate device addresses. The shift register number corresponds to the first, or head bit. The number of bits is the second required address after the SFR instruction.

The SFR instruction requires three inputs. The forward shift register circuit must be programmed in the following order: reset input, pulse input, data input, and the SFR instruction, followed by the first bit and the number of bits.

Ladder Diagram

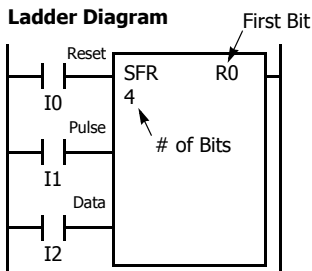

| | |
|-----------|------------|
| First Bit | R0 to R127 |
| # of Bits | 1 to 128 |

Program List

| Instruction | Data |
|-------------|------|
| LOD | I0 |
| LOD | I1 |
| LOD | I2 |
| SFR | R0 |
| | 4 |

Structural Diagram

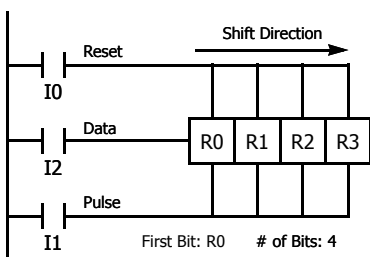

Reset Input

The reset input will cause the value of each bit of the shift register to return to zero. Initialize pulse special internal relay, M8120, may be used to initialize the shift register at start-up.

Pulse Input

The pulse input triggers the data to shift. The shift is in the forward direction for a forward shift register and in reverse for a reverse shift register. A data shift will occur upon the leading edge of a pulse; that is, when the pulse *turns on*. If the pulse has been on and stays on, no data shift will occur.

Data Input

The data input is the information which is shifted into the first bit when a forward data shift occurs, or into the last bit when a reverse data shift occurs.

Note: When power is turned off, the statuses of all shift register bits are normally cleared. It is also possible to maintain the statuses of shift register bits by using the Function Area Settings as required. See Chapter 5 "Special Functions" - "Keep Designation for Internal Relays, Shift Registers, Counters, and Data Registers" in the SmartAXIS Pro/Lite User's Manual.

Note: The SFR instruction cannot be used in an interrupt program. If used, a user program execution error will result, turning on special internal relay M8004 and the ERR LED on the SmartAXIS. For details about the user program execution errors, see "User Program Execution Errors" on page 4-13.

Note: For restrictions on ladder programming of shift register instructions, see "Restriction on Ladder Programming" on page 5-31.

Ladder Diagram

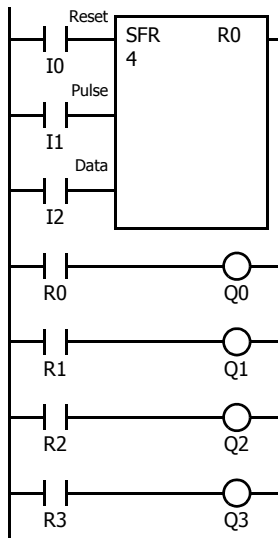

Program List

| Instruction | Data |
|-------------|------|
| LOD | I0 |
| LOD | I1 |
| LOD | I2 |
| SFR | R0 |
| | 4 |
| LOD | R0 |
| OUT | Q0 |
| LOD | R1 |
| OUT | Q1 |
| LOD | R2 |
| OUT | Q2 |
| LOD | R3 |
| OUT | Q3 |

Timing Chart

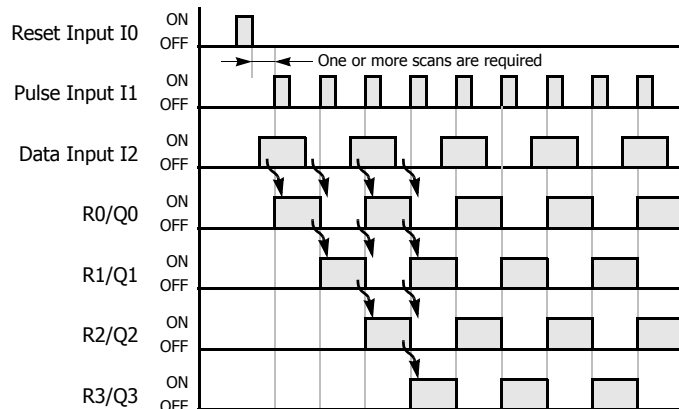

Ladder Diagram

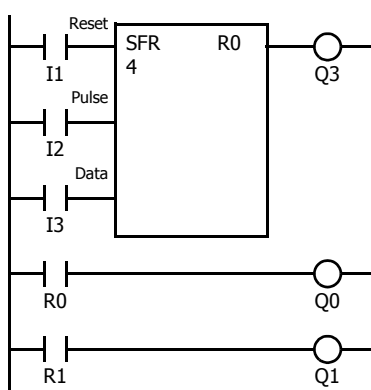

Program List

| Instruction | Data |
|-------------|------|
| LOD | I1 |
| LOD | I2 |
| LOD | I3 |
| SFR | R0 |
| | 4 |
| OUT | Q3 |
| LOD | R0 |
| OUT | Q0 |
| LOD | R1 |
| OUT | Q1 |

- The last bit status output can be programmed directly after the SFR instruction. In this example, the status of bit R3 is read to output Q3.
- Each bit can be loaded using the LOD R# instruction.

Setting and Resetting Shift Register Bits

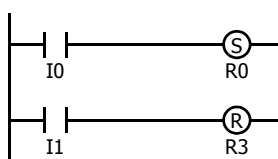

- Any shift register bit can be turned on using the SET instruction.
- Any shift register bit can be turned off using the RST instruction.
- The SET or RST instruction is actuated by any input condition.

Reverse Shift Register (SFRN)

For reverse shifting, use the SFRN instruction. When SFRN instructions are programmed, two addresses are always required. The SFRN instructions are entered, followed by a shift register number selected from appropriate device addresses. The shift register number corresponds to the lowest bit number in a string. The number of bits is the second required address after the SFRN instructions.

The SFRN instruction requires three inputs. The reverse shift register circuit must be programmed in the following order: reset input, pulse input, data input, and the SFRN instruction, followed by the last bit and the number of bits.

Ladder Diagram

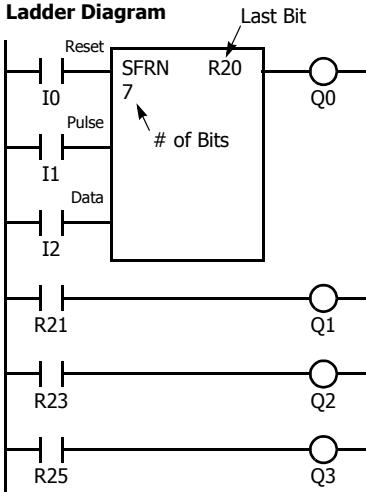

| | |
|-----------|------------|
| Last Bit | R0 to R127 |
| # of Bits | 1 to 128 |

Program List

| Instruction | Data |
|-------------|------|
| LOD | I0 |
| LOD | I1 |
| LOD | I2 |
| SFRN | R20 |
| | 7 |
| OUT | Q0 |
| LOD | R21 |
| OUT | Q1 |
| LOD | R23 |
| OUT | Q2 |
| LOD | R25 |
| OUT | Q3 |

- The last bit status output can be programmed directly after the SFRN instruction. In this example, the status of bit R20 is read to output Q0.
- Each bit can be loaded using the LOD R# instructions.
- For details of reset, pulse, and data inputs, see "Forward Shift Register (SFR)" on page 5-22.

Structural Diagram

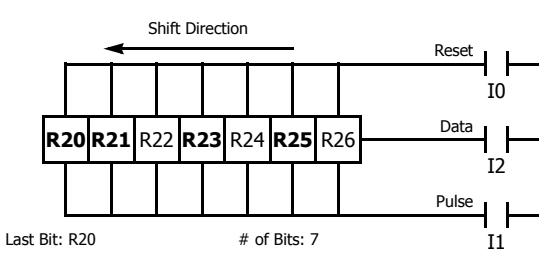

Note: Output is initiated only for those bits highlighted in bold print.

Note: When power is turned off, the statuses of all shift register bits are normally cleared. It is also possible to maintain the statuses of shift register bits by using the Function Area Settings as required. See Chapter 5 "Special Functions" - "Keep Designation for Internal Relays, Shift Registers, Counters, and Data Registers" in the SmartAXIS Pro/Lite User's Manual.

Note: The SFRN instruction cannot be used in an interrupt program. If used, a user program execution error will result, turning on special internal relay M8004 and the ERR LED on the SmartAXIS. For details about the user program execution errors, see "User Program Execution Errors" on page 4-13.

Note: For restrictions on ladder programming of shift register instructions, see "Restriction on Ladder Programming" on page 5-31.

Bidirectional Shift Register

A bidirectional shift register can be created by first programming the SFR instruction as detailed in the Forward Shift Register section on page 5-22. Next, the SFRN instruction is programmed as detailed in the Reverse Shift Register section on page 5-24.

Ladder Diagram

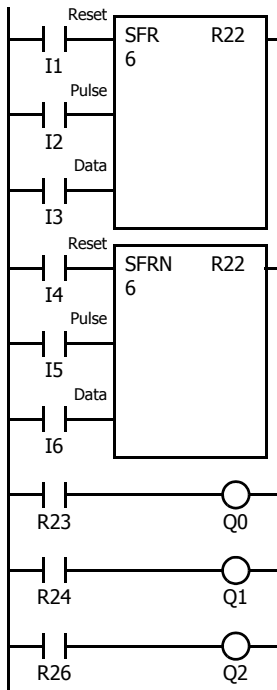

Program List

| Instruction | Data |
|-------------|------|
| LOD | I1 |
| LOD | I2 |
| LOD | I3 |
| SFR | R22 |
| | 6 |
| LOD | I4 |
| LOD | I5 |
| LOD | I6 |
| SFRN | R22 |
| | 6 |
| LOD | R23 |
| OUT | Q0 |
| LOD | R24 |
| OUT | Q1 |
| LOD | R26 |
| OUT | Q2 |

Structural Diagram

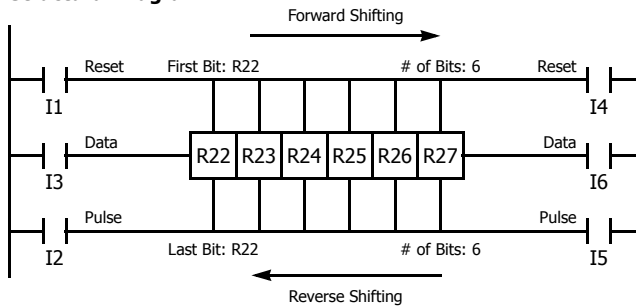

Note: Output is initiated only for those bits highlighted in bold print.

SOTU and SOTD (Single Output Up and Down)

The SOTU instruction “looks for” the transition of a given input from off to on. The SOTD instruction looks for the transition of a given input from on to off. When this transition occurs, the desired output will turn on for the length of one scan. The SOTU or SOTD instruction converts an input signal to a “one-shot” pulse signal.

A total of 1024 SOTU and SOTD instructions can be used in a user program.

If operation is started while the given input is already on, the SOTU output will not turn on. The transition from off to on is what triggers the SOTU instruction.

The SOTU or SOTD instructions cannot be used in an interrupt program.

If used, a user program execution error will result, turning on special internal relay M8004 and the ERR LED on the SmartAXIS. For details about the user program execution errors, see "User Program Execution Errors" on page 4-13.

When a CPU relay is defined as the SOTU or SOTD output, it may not operate if the scan time is not compatible with relay requirements.

Ladder Diagram

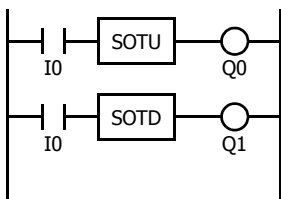

Program List

| Instruction | Data |
|-------------|------|
| LOD | I0 |
| SOTU | |
| OUT | Q0 |
| LOD | I0 |
| SOTD | |
| OUT | Q1 |

Note: For restrictions on ladder programming of SOTU and SOTD instructions, see "Restriction on Ladder Programming" on page 5-31.

Timing Chart

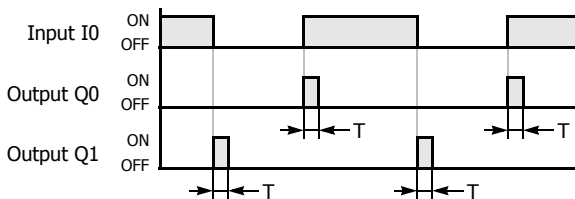

Note: “T” equals one scan time (one-shot pulse).

There is a special case when the SOTU and SOTD instructions are used between the MCS and MCR instructions (see "MCS and MCR (Master Control Set and Reset)" on page 5-27). If input I2 to the SOTU instruction turns on while input I1 to the MCS instruction is on, then the SOTU output turns on. If input I2 to the SOTD instruction turns off while input I1 is on, then the SOTD output turns on. If input I1 turns on while input I2 is on, then the SOTU output turns on. However, if input I1 turns off while input I2 is on, then the SOTD output does not turn on as shown below.

Ladder Diagram

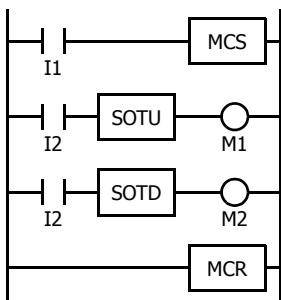

Timing Chart

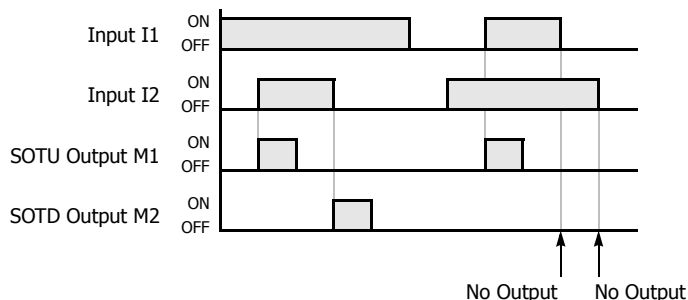

MCS and MCR (Master Control Set and Reset)

The MCS (master control set) instruction is usually used in combination with the MCR (master control reset) instruction. The MCS instruction can also be used with the END instruction, instead of the MCR instruction.

When the input preceding the MCS instruction is off, the MCS is executed so that all inputs to the portion between the MCS and the MCR are forced off. When the input preceding the MCS instruction is on, the MCS is not executed so that the program following it is executed according to the actual input statuses.

When the input condition to the MCS instruction is off and the MCS is executed, other instructions between the MCS and MCR are executed as follows:

| Instruction | Status |
|-------------------------------|--|
| SOTU | Rising edges (ON pulses) are not detected. |
| SOTD | Falling edges (OFF pulses) are not detected. |
| OUT | All are turned off. |
| OUTN | All are turned on. |
| SET and RST | All are held in current status. |
| TML, TIM, TMH, and TMS | Current values are reset to zero. Timeout statuses are turned off. |
| CNT, CDP, and CUD | Current values are held. Pulse inputs are turned off. Countout statuses are turned off. |
| SFR and SFRN | Shift register bit statuses are held. Pulse inputs are turned off. The output from the last bit is turned off. |

Input conditions cannot be set for the MCR instruction.

More than one MCS instruction can be used with one MCR instruction.

Corresponding MCS/MCR instructions cannot be nested within another pair of corresponding MCS/MCR instructions.

Ladder Diagram

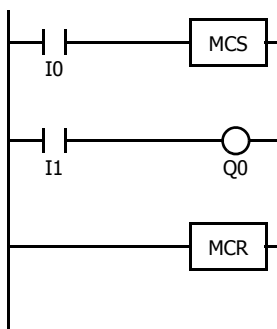

Program List

| Instruction | Data |
|-------------|------|
| LOD | I0 |
| MCS | |
| LOD | I1 |
| OUT | Q0 |
| MCR | |

Timing Chart

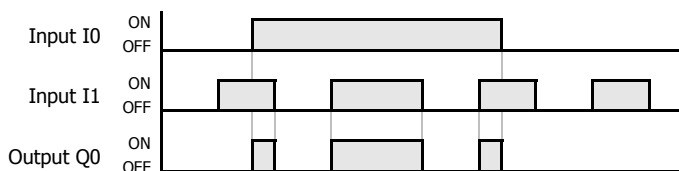

When input I0 is off, MCS is executed so that the subsequent input is forced off.

When input I0 is on, MCS is not executed so that the following program is executed according to the actual input statuses.

Multiple Usage of MCS instructions

Ladder Diagram

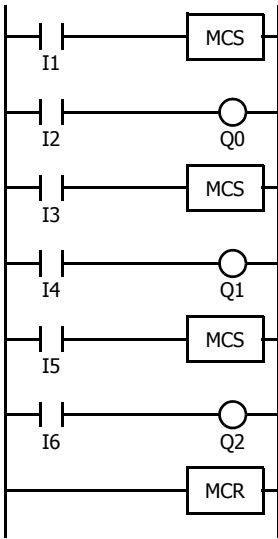

Program List

| Instruction | Data |
|-------------|------|
| LOD | I1 |
| MCS | |
| LOD | I2 |
| OUT | Q0 |
| LOD | I3 |
| MCS | |
| LOD | I4 |
| OUT | Q1 |
| LOD | I5 |
| MCS | |
| LOD | I6 |
| OUT | Q2 |
| MCR | |

This master control circuit will give priority to I1, I3, and I5, in that order.

When input I1 is off, the first MCS is executed so that subsequent inputs I2 through I6 are forced off.

When input I1 is on, the first MCS is not executed so that the following program is executed according to the actual input statuses of I2 through I6.

When I1 is on and I3 is off, the second MCS is executed so that subsequent inputs I4 through I6 are forced off.

When both I1 and I3 are on, the first and second MCSs are not executed so that the following program is executed according to the actual input statuses of I4 through I6.

Counter and Shift Register in Master Control Circuit

Ladder Diagram

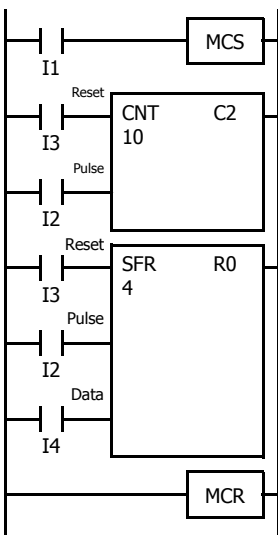

When input I1 is on, the MCS is not executed so that the counter and shift register are executed according to the actual status of subsequent inputs I2 through I4.

When input I1 is off, the MCS is executed so that subsequent inputs I2 through I4 are forced off.

When input I1 is turned on while input I2 is on, the counter and shift register pulse inputs are turned on as shown below.

Timing Chart

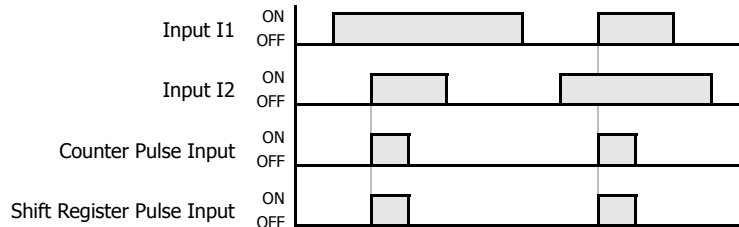

JMP (Jump) and JEND (Jump End)

The JMP (jump) instruction is usually used in combination with the JEND (jump end) instruction. At the end of a program, the JMP instruction can also be used with the END instruction, instead of the JEND instruction.

These instructions are used to proceed through the portion of the program between the JMP and the JEND *without* processing. This is similar to the MCS/MCR instructions, except that the portion of the program between the MCS and MCR instruction *is* executed.

When the operation result immediately before the JMP instruction is on, the JMP is valid and the program is *not* executed. When the operation result immediately before the JMP instruction is off, the JMP is invalid and the program is executed.

When the input condition to the JMP instruction is on and the JMP is executed, other instructions between the JMP and JEND are executed as follows:

| Instruction | Status |
|-------------------------------|--|
| SOTU | Rising edges (ON pulses) are not detected. |
| SOTD | Falling edges (OFF pulses) are not detected. |
| OUT and OUTN | All are held in current status. |
| SET and RST | All are held in current status. |
| TML, TIM, TMH, and TMS | Current values are held. Timeout statuses are held. |
| CNT, CDP, and CUD | Current values are held. Pulse inputs are turned off. Countout statuses are held. |
| SFR and SFRN | Shift register bit statuses are held. Pulse inputs are turned off. The output from the last bit is held. |

Input conditions cannot be set for the JEND instruction.

More than one JMP instruction can be used with one JEND instruction.

Corresponding JMP/JEND instructions cannot be nested within another pair of corresponding JMP/JEND instructions.

Ladder Diagram

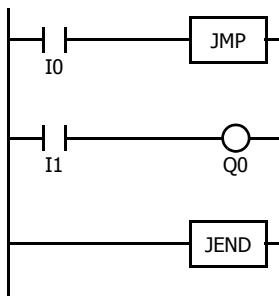

Program List

| Instruction | Data |
|-------------|------|
| LOD | I0 |
| JMP | |
| LOD | I1 |
| OUT | Q0 |
| JEND | |

Timing Chart

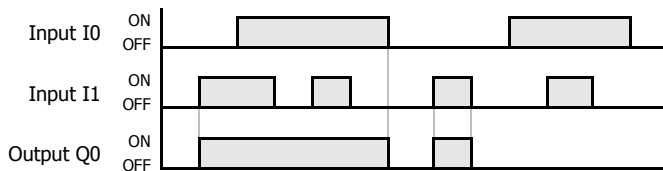

When input I0 is on, JMP is executed so that the subsequent output status is held.

When input I0 is off, JMP is not executed so that the following program is executed according to the actual input statuses.

Ladder Diagram

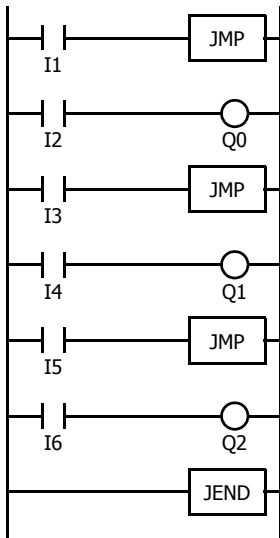

Program List

| Instruction | Data |
|-------------|------|
| LOD | I1 |
| JMP | |
| LOD | I2 |
| OUT | Q0 |
| LOD | I3 |
| JMP | |
| LOD | I4 |
| OUT | Q1 |
| LOD | I5 |
| JMP | |
| LOD | I6 |
| OUT | Q2 |
| JEND | |

This jump circuit will give priority to I1, I3, and I5, in that order.

When input I1 is on, the first JMP is executed so that subsequent output statuses of Q0 through Q2 are held.

When input I1 is off, the first JMP is not executed so that the following program is executed according to the actual input statuses of I2 through I6.

When I1 is off and I3 is on, the second JMP is executed so that subsequent output statuses of Q1 and Q2 are held.

When both I1 and I3 are off, the first and second JMPs are not executed so that the following program is executed according to the actual input statuses of I4 through I6.

END

The END instruction is always required at the end of a program; however, it is not necessary to program the END instruction after the last programmed instruction. WindLDR automatically appends the END instruction at the end of a program.

A *scan* is the execution of all instructions from address zero to the END instruction. The time required for this execution is referred to as one *scan time*. The scan time varies with respect to program length, which corresponds to the address where the END instruction is found.

During the scan time, program instructions are processed sequentially. This is why the output instruction closest to the END instruction has priority over a previous instruction for the same output. No output is initiated until all logic within a scan is processed.

Output occurs simultaneously, and this is the first part of the END instruction execution. The second part of the END instruction execution is to monitor all inputs, also done simultaneously. Then program instructions are ready to be processed sequentially once again.

Ladder Diagram

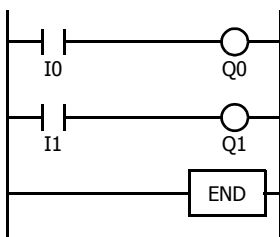

Program List

| Instruction | Data |
|-------------|------|
| LOD | I0 |
| OUT | Q0 |
| LOD | I1 |
| OUT | Q1 |
| END | |

Restriction on Ladder Programming

Due to the structure of WindLDR, the following ladder diagram cannot be programmed — a closed circuit block is formed by vertical lines, except for right and left power rails, and the closed circuit block contains one or more prohibited instructions shown in the table below.

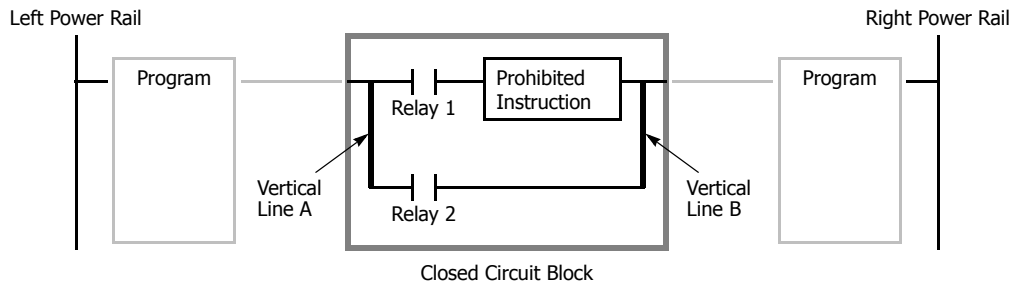

| | |
|--------------------------------|--|
| Prohibited Instructions | OUT, OUTN, SET, RST, TML, TIM, TMH, TMS, TMLO, TIMO, TMHO, TMSO, CNT, CDP, CUD, CNTD, CDPD, CUDD, SFR, SFRN, SOTU, SOTD |
| Error Detection | When converting the ladder program, an error message is shown, such as "TIM follows an invalid device." Conversion fails to create mnemonics and the program is not downloaded to the SmartAXIS. |

Modifying Prohibited Ladder Programs

Intended operation can be performed by modifying the prohibited ladder program as shown in the examples below:

Prohibited Ladder Program 1

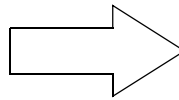
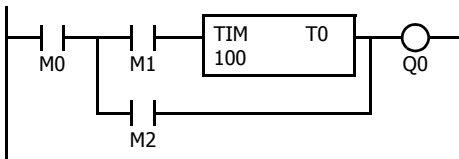

Modified Ladder Program 1

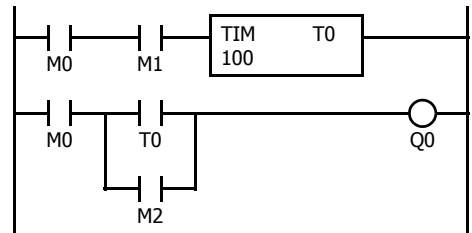

Prohibited Ladder Program 2

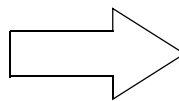
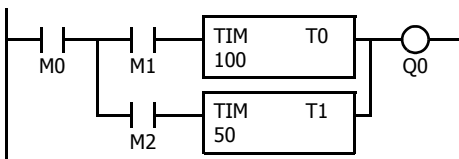

Modified Ladder Program 2

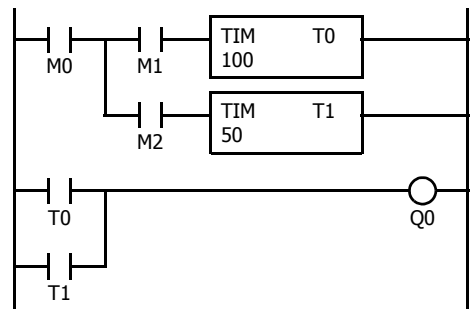

6: MOVE INSTRUCTIONS

Introduction

Data can be moved using the MOV (move), MOVN (move not), IMOV (indirect move), or IMOVN (indirect move not) instruction. The moved data is 16- or 32-bit data, and the repeat operation can also be used to increase the quantity of data moved. In the MOV or MOVN instruction, the source and destination device are designated by S1 and D1 directly. In the IMOV or IMOVN instruction, the source and destination device are determined by the offset values designated by S2 and D2 added to source device S1 and destination device D1.

The BMOV (block move) instruction is useful to move consecutive blocks of timer, counter, and data register values.

The IBMV (indirect bit move) and IBMVN (indirect bit move not) instructions move one bit of data from a source device to a destination device. Both devices are determined by adding an offset to the device.

NSET (N data set) and NRS (N data repeat set) instructions can be used to set values to a group of devices. The XCHG (exchange) instruction is used to swap word or double-word data between two devices. The current timer or counter values can be changed using the TCCST (timer/counter current value store) instruction.

Since the move instructions are executed in each scan while input is on, a pulse input from a SOTU or SOTD instruction should be used.

MOV (Move)

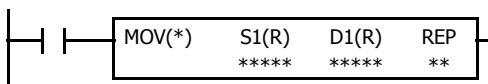

S1 → D1

When input is on, 16- or 32-bit data from device assigned by S1 is moved to device assigned by D1.

Applicable SmartAXIS

| FT1A-12 | FT1A-24 | FT1A-40 | FT1A-48 | FT1A-Touch |
|---------|---------|---------|---------|------------|
| X | X | X | X | X |

Valid Devices

| Device | Function | I | Q | M | R | T | C | D | Constant | Repeat |
|--------------------|---------------------------------|---|---|---|---|---|---|---|----------|--------|
| S1 (Source 1) | First device address to move | X | X | X | X | X | X | X | X | 1-99 |
| D1 (Destination 1) | First device address to move to | — | X | ▲ | X | X | X | X | — | 1-99 |

For valid device address ranges, see "Device Addresses" on page 3-1.

▲ Internal relays M0 through M1277 can be designated as D1. Special internal relays cannot be designated as D1.

Both internal relays M0 through M1277 and special internal relays M8000 through M8177 can be designated as source devices.

When T (timer) or C (counter) is used as S1, the timer/counter current value (TC or CC) is displayed. When T (timer) or C (counter) is used as D1, the data is written in as a preset value (TP or CP) which can be 0 through 65535.

When F (float) data is selected, only data register and constant can be designated as S1, and only data register can be designated as D1.

When F (float) data is selected and S1 does not comply with the normal floating-point format, a user program execution error will result, turning on special internal relay M8004 and ERR LED on the SmartAXIS. For user program execution errors, see "User Program Execution Errors" on page 4-13.

Valid Data Types

| | |
|------------------------|---|
| W (word) | X |
| I (integer) | X |
| D (double word) | X |
| L (long) | X |
| F (float) | X |

When a bit device such as I (input), Q (output), M (internal relay), or R (shift register) is assigned as the source or destination, 16 points (word or integer data) or 32 points (double-word or long data) are used. When repeat is assigned for a bit device, the quantity of device bits increases in 16- or 32-point increments.

When a word device such as T (timer), C (counter), or D (data register) is assigned as the source or destination, 1 point (word or integer data) or 2 points (double-word, long, or float data) are used. When repeat is assigned for a word device, the quantity of device words increases in 1- or 2-point increments.

6: MOVE INSTRUCTIONS

Examples: MOV

Data Type: Word

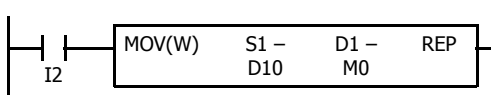

D10 → M0

When input I2 is on, data in data register D10 assigned by source device S1 is moved to 16 internal relays starting with M0 assigned by destination device D1.

D10 12345 → M0 through M7, M10 through M17

Data in the source data register is converted into 16-bit binary data, and the ON/OFF statuses of the 16 bits are moved to internal relays M0 through M7 and M10 through M17. M0 is the LSB (least significant bit). M17 is the MSB (most significant bit).

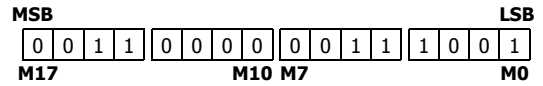

Data Type: Word

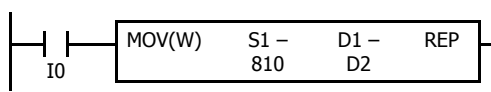

810 → D2

When input I0 is on, constant 810 assigned by source device S1 is moved to data register D2 assigned by destination device D1.

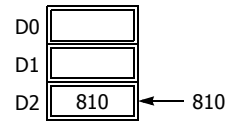

Data move operation for integer data is the same as for word data.

Data Type: Double Word

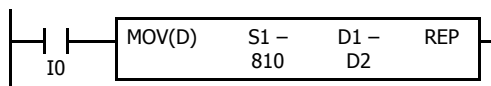

810 → D2·D3

When input I0 is on, constant 810 assigned by source device S1 is moved to data registers D2 and D3 assigned by destination device D1.

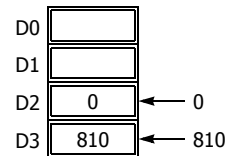

Data move operation for the long data type is the same as for the double-word data type.

Data Type: Word

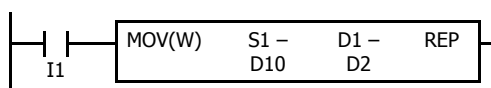

D10 → D2

When input I1 is on, data in data register D10 assigned by source device S1 is moved to data register D2 assigned by destination device D1.

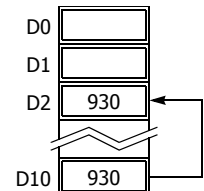

Data Type: Double Word

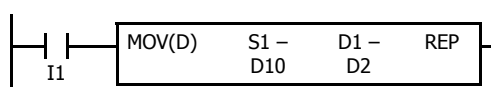

D10·D11 → D2·D3

When input I1 is on, data in data registers D10 and D11 assigned by source device S1 is moved to data registers D2 and D3 assigned by destination device D1.

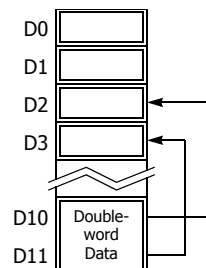

Double-word Data Move in Data Registers

When a data register, timer, or counter is selected as a double-word device, the upper-word data is loaded from or stored to the first device selected. The lower-word data is loaded from or stored to the subsequent device.

Double-word Destination Device: Data Register

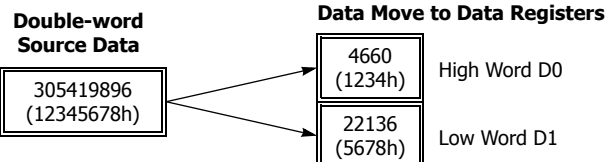
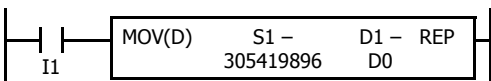

Repeat Operation in the Move Instructions

Repeat Source Device

When the S1 (source) is set to repeat, as many devices as the repeat cycles, starting with the device designated by S1, are moved to the destination. As a result, only the last of the source devices is moved to the destination.

- **Data Type: Word**

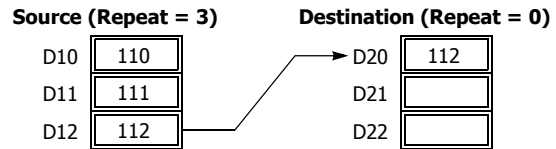
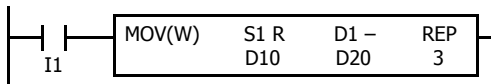

- **Data Type: Double Word**

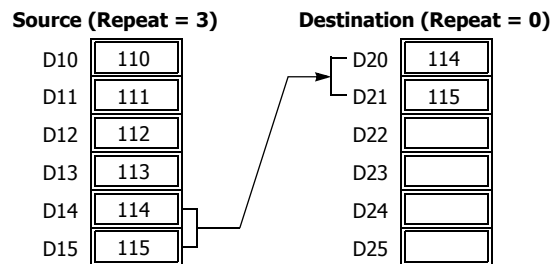
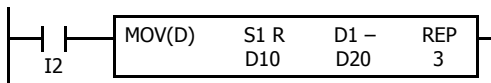

Repeat Destination Device

When the D1 (destination) is designated to repeat, the source device designated by S1 is moved to all destination devices as many times as the repeat cycles, starting with the destination designated by D1.

- **Data Type: Word**

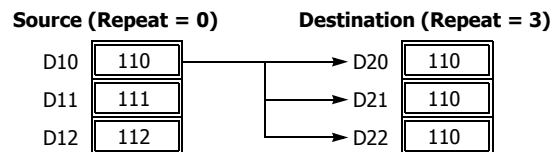
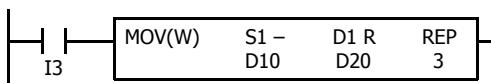

- **Data Type: Double Word**

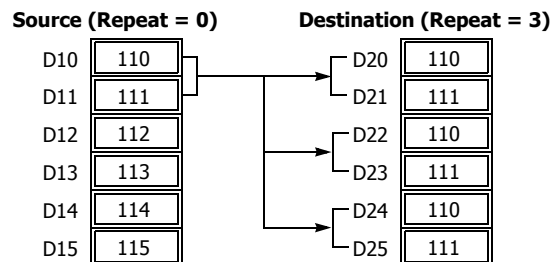
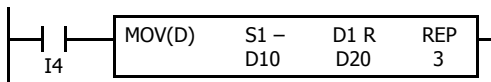

Repeat Source and Destination Devices

When both S1 (source) and D1 (destination) are set to repeat, as many devices as the repeat cycles, starting with the device designated by S1, are moved to the same quantity of devices starting with the device designated by D1.

Note: The BMOV (block move) instruction has the same effect as the MOV instruction with both the source and destination designated to repeat.

- **Data Type: Word**

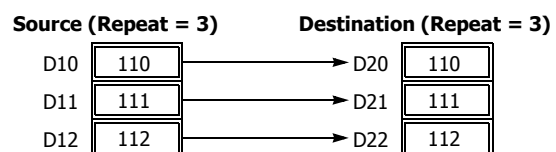
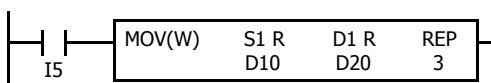

6: MOVE INSTRUCTIONS

• Data Type: Double Word

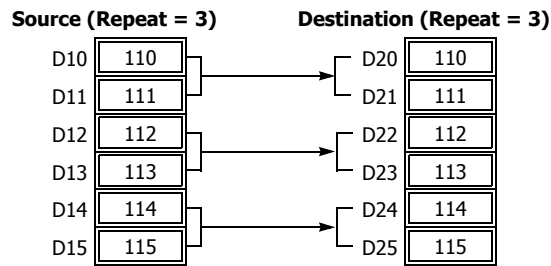
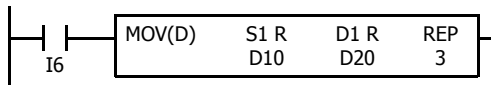

• Data Type: Float

When the source data does not comply with the normal floating-point format in any repeat operation, a user program execution error occurs, and the source data is not moved to the destination.

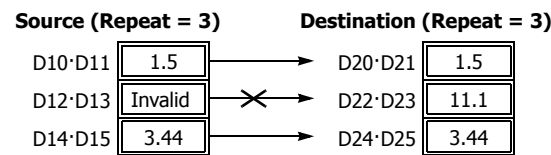
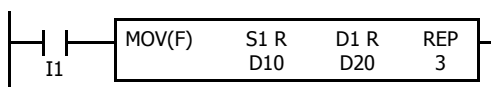

Repeat Bit Devices

The MOV (move) instruction moves 16-bit data (word or integer data) or 32-bit data (double-word or integer data). When a bit device such as input, output, internal relay, or shift register is designated as the source or destination device, 16 or 32 bits starting with the one designated by S1 or D1 are the target data. If a repeat operation is designated for a bit device, the target data increases in 16- or 32-bit increments, depending on the selected data type.

• Data Type: Word

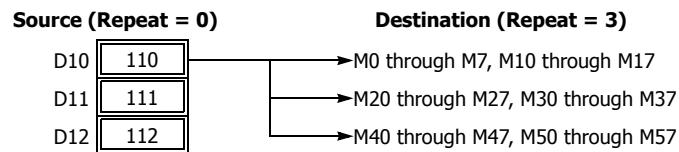
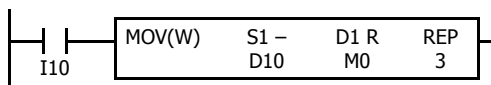

• Data Type: Double Word

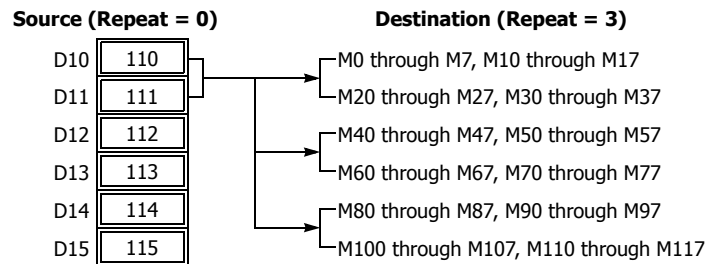
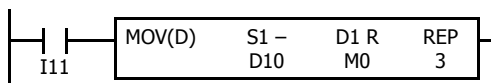

Overlapped Devices by Repeat

If the repeat operation is set for both the source and destination and if a portion of the source and destination areas overlap each other, then the source data in the overlapped area also changes.

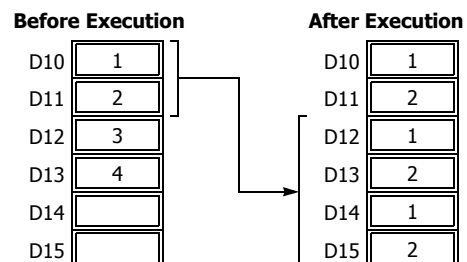
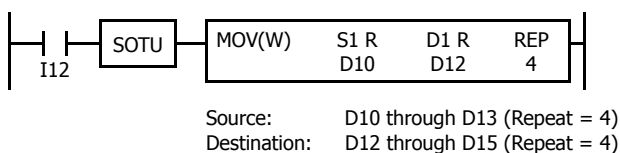

MOVN (Move Not)

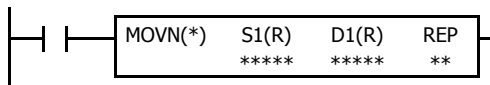

S1 NOT → D1

When input is on, 16- or 32-bit data from device assigned by S1 is inverted bit by bit and moved to device assigned by D1.

Applicable SmartAXIS

| FT1A-12 | FT1A-24 | FT1A-40 | FT1A-48 | FT1A-Touch |
|---------|---------|---------|---------|------------|
| X | X | X | X | X |

Valid Devices

| Device | Function | I | Q | M | R | T | C | D | Constant | Repeat |
|--------------------|---------------------------------|---|---|---|---|---|---|---|----------|--------|
| S1 (Source 1) | First device address to move | X | X | X | X | X | X | X | X | 1-99 |
| D1 (Destination 1) | First device address to move to | — | X | ▲ | X | X | X | X | — | 1-99 |

For valid device address ranges, see "Device Addresses" on page 3-1.

▲ Internal relays M0 through M1277 can be designated as D1. Special internal relays cannot be designated as D1.

When T (timer) or C (counter) is used as S1, the timer/counter current value (TC or CC) is displayed. When T (timer) or C (counter) is used as D1, the data is written in as a preset value (TP or CP) which can be 0 through 65535.

Valid Data Types

| | | |
|------------------------|---|---|
| W (word) | X | When a bit device such as I (input), Q (output), M (internal relay), or R (shift register) is assigned as the source or destination, 16 points (word or integer data) or 32 points (double-word or long data) are used. When repeat is set for a bit device, the quantity of device bits increases in 16- or 32-point increments. |
| I (integer) | X | |
| D (double word) | X | |
| L (long) | X | When a word device such as T (timer), C (counter), or D (data register) is assigned as the source or destination, 1 point (word or integer data) or 2 points (double-word or long data) are used. When repeat is set for a word device, the quantity of device words increases in 1- or 2-point increments. |
| F (float) | — | |

Examples: MOVN

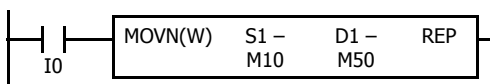

M10 NOT → M50

When input I0 is on, the 16 internal relays, starting with M10 assigned by source device S1, are inverted bit by bit and moved to 16 internal relays starting with M50 assigned by destination device D1.

M10 through M17, M20 through M27 NOT → M50 through M57, M60 through M67

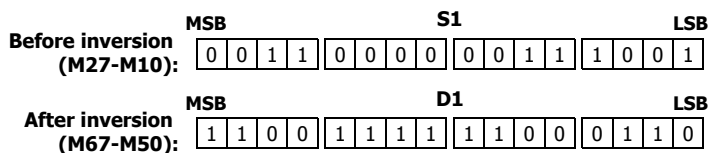

The ON/OFF statuses of the 16 internal relays M10 through M17 and M20 through M27 are inverted and moved to 16 internal relays M50 through M57 and M60 through M67. M50 is the LSB (least significant bit), and M67 is the MSB (most significant bit).

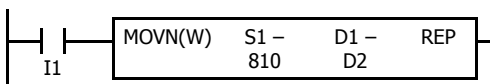

810 NOT → D2

When input I1 is on, decimal constant 810 assigned by source device S1 is converted into 16-bit binary data, and the ON/OFF statuses of the 16 bits are inverted and moved to data register D2 assigned by destination device D1.

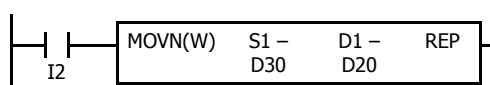
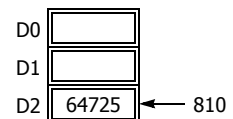
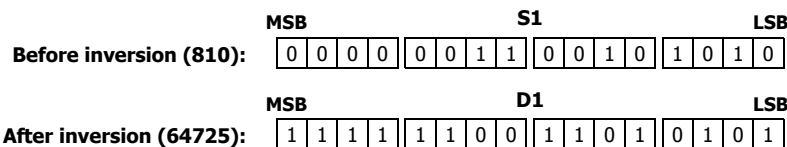

D30 NOT → D20

When input I2 is on, the data in data register D30, assigned by S1, is inverted bit by bit and moved to data register D20 assigned by D1.

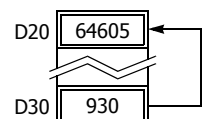

6: MOVE INSTRUCTIONS

IMOV (Indirect Move)

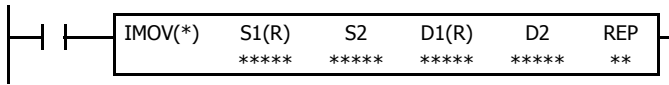

$S1 + S2 \rightarrow D1 + D2$

When input is on, the values contained in devices assigned by S1 and S2 are added together to determine the data source. The 16- or 32-bit data is then moved to the destination, which is determined by the sum of values contained in devices assigned by D1 and D2.

Applicable SmartAXIS

| FT1A-12 | FT1A-24 | FT1A-40 | FT1A-48 | FT1A-Touch |
|---------|---------|---------|---------|------------|
| X | X | X | X | X |

Valid Devices

| Device | Function | I | Q | M | R | T | C | D | Constant | Repeat |
|--------------------|---------------------------|---|---|---|---|---|---|---|----------|--------|
| S1 (Source 1) | Base address to move from | X | X | X | X | X | X | X | — | 1-99 |
| S2 (Source 2) | Offset for S1 | X | X | X | X | X | X | X | — | — |
| D1 (Destination 1) | Base address to move to | — | X | ▲ | X | X | X | X | — | 1-99 |
| D2 (Destination 2) | Offset for D1 | X | X | X | X | X | X | X | — | — |

For valid device address ranges, see "Device Addresses" on page 3-1.

▲ Internal relays M0 through M1277 can be designated as D1. Special internal relays cannot be designated as D1.

When T (timer) or C (counter) is used as S1, S2, or D2, the device data is the timer/counter current value (TC or CC). When T (timer) or C (counter) is used as D1, the device data is the timer/counter preset value (TP or CP) which can be 0 through 65535.

When F (float) data is selected, only data register can be designated as S1 or D1.

When F (float) data is selected and S1 does not comply with the normal floating-point format, a user program execution error will result, turning on special internal relay M8004 and ERR LED on the SmartAXIS.

Source device S2 or destination device D2 does not have to be assigned. If S2 or D2 is not assigned, the source or destination device is determined by S1 or D1 without offset.

Make sure that the source data determined by $S1 + S2$ and the destination data determined by $D1 + D2$ are within the valid device range. If the derived source or destination device exceeds the valid device range, a user program execution error will result, turning on special internal relay M8004 and the ERR LED on the SmartAXIS. For user program execution errors, see "User Program Execution Errors" on page 4-13.

When you specify D0000 to D0999 as S1, make sure that $S1+(S2)$ does not exceed D0999. In order to specify D1000 to D1999 as source device with $S1+(S2)$, specify D1000 to D1999 as S1.

When you specify D0000 to D0999 as D1, make sure that $D1+(D2)$ does not exceed D0999. In order to specify D1000 to D1999 as destination device with $D1+(D2)$, specify D1000 to D1999 as D1.

Valid Data Types

| | |
|------------------------|---|
| W (word) | X |
| I (integer) | — |
| D (double word) | X |
| L (long) | — |
| F (float) | X |

When a bit device such as I (input), Q (output), M (internal relay), or R (shift register) is assigned as the source or destination, 16 points (word data) or 32 points (double-word data) are used. When repeat is assigned for a bit device, the quantity of device bits increases in 16- or 32-point increments.

When a word device such as T (timer), C (counter), or D (data register) is assigned as the source or destination, 1 point (word data) or 2 points (double-word or float data) are used. When repeat is assigned for a word device, the quantity of device words increases in 1- or 2-point increments.

Example: IMOV

• **Data Type: Word**

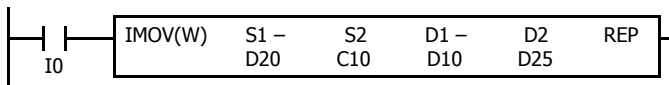

$D20 + C10 \rightarrow D10 + D25$

Source device S1 and destination device D1 determine the type of device. Source device S2 and destination device D2 are the offset values to determine the source and destination devices.

If the current value of counter C10 assigned by source device S2 is 4, the source data is determined by adding the offset value to data register D20 assigned by source device S1:

$D(20 + 4) = D24$

If data register D25 contains a value of 20, the destination is determined by adding the offset value to data register D10 assigned by destination device D1:

$D(10 + 20) = D30$

As a result, when input I0 is on, the data in data register D24 is moved to data register D30.

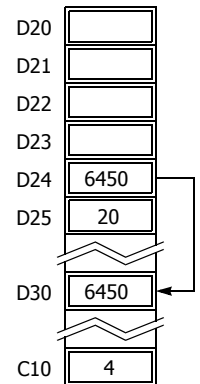

• **Data Type: Float**

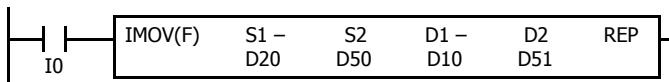

$D20 + D50 \rightarrow D10 + D51$

If data register D50 contains a value of 2, the source data is determined by adding the offset value to data register D20 assigned by source device S1: $D(20 + 2) = D22$

If data register D51 contains a value of 20, the destination is determined by adding the offset value to data register D10 assigned by destination device D1: $D(10 + 20) = D30$

As a result, when input I0 is on, the data in data registers D22·D23 is moved to data registers D30·D31.

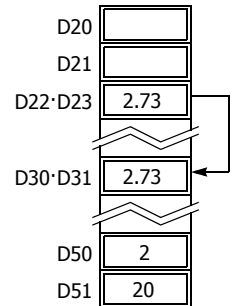

6: MOVE INSTRUCTIONS

IMOVN (Indirect Move Not)

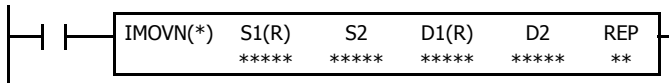

$S1 + S2 \text{ NOT} \rightarrow D1 + D2$

When input is on, the values contained in devices assigned by S1 and S2 are added together to determine the data source. The 16- or 32-bit data is then inverted and moved to the destination, which is determined by the sum of values contained in devices assigned by D1 and D2.

When you specify D0000 to D0999 as S1, make sure that $S1+(S2)$ does not exceed D0999. In order to specify D1000 to D1999 as source device with $S1+(S2)$, specify D1000 to D1999 as S1.

When you specify D0000 to D0999 as D1, make sure that $D1+(D2)$ does not exceed D0999. In order to specify D1000 to D1999 as destination device with $D1+(D2)$, specify D1000 to D1999 as D1.

Applicable SmartAXIS

| FT1A-12 | FT1A-24 | FT1A-40 | FT1A-48 | FT1A-Touch |
|---------|---------|---------|---------|------------|
| X | X | X | X | X |

Valid Devices

| Device | Function | I | Q | M | R | T | C | D | Constant | Repeat |
|--------------------|---------------------------|---|---|---|---|---|---|---|----------|--------|
| S1 (Source 1) | Base address to move from | X | X | X | X | X | X | X | — | 1-99 |
| S2 (Source 2) | Offset for S1 | X | X | X | X | X | X | X | — | — |
| D1 (Destination 1) | Base address to move to | — | X | ▲ | X | X | X | X | — | 1-99 |
| D2 (Destination 2) | Offset for D1 | X | X | X | X | X | X | X | — | — |

For valid device address ranges, see "Device Addresses" on page 3-1.

▲ Internal relays M0 through M1277 can be designated as D1. Special internal relays cannot be designated as D1.

When T (timer) or C (counter) is used as S1, S2, or D2, the device data is the timer/counter current value (TC or CC). When T (timer) or C (counter) is used as D1, the device data is the timer/counter preset value (TP or CP), 0 through 65535.

Source device S2 or destination device D2 does not have to be assigned. If S2 or D2 is not assigned, the source or destination device is determined by S1 or D1 without offset.

Make sure that the source data determined by $S1 + S2$ and the destination data determined by $D1 + D2$ are within the valid device range. If the derived source or destination device exceeds the valid device range, a user program execution error will result, turning on special internal relay M8004 and the ERR LED on the SmartAXIS. For user program execution errors, see "User Program Execution Errors" on page 4-13.

Valid Data Types

| | |
|------------------------|---|
| W (word) | X |
| I (integer) | — |
| D (double word) | X |
| L (long) | — |
| F (float) | — |

When a bit device such as I (input), Q (output), M (internal relay), or R (shift register) is assigned as the source or destination, 16 points (word data) or 32 points (double-word data) are used. When repeat is set for a bit device, the quantity of device bits increases in 16- or 32-point increments.

When a word device such as T (timer), C (counter), or D (data register) is assigned as the source or destination, 1 point (word data) or 2 points (double-word data) are used. When repeat is assigned for a word device, the quantity of device words increases in 1- or 2-point increments.

Example: IMOVN

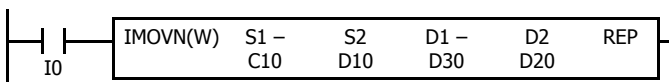

$C10 + D10 \text{ NOT} \rightarrow D30 + D20$

Source device S1 and destination device D1 determine the type of device. Source device S2 and destination device D2 are the offset values used to determine the source and destination devices.

If the data of data register D10 assigned by source device S2 is 4, then the source data is determined by adding the offset value to counter C10 assigned by source device S1:

$$C(10 + 4) = C14$$

If data register D20 assigned by destination device D2 contains a value of 15, then the destination is determined by adding the offset value to data register D30 assigned by destination device D1:

$$D(30 + 15) = D45$$

As a result, when input I0 is on, the current value of counter C14 is inverted and moved to data register D45.

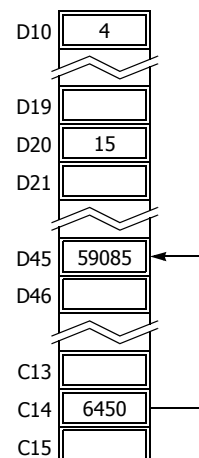

BMOV (Block Move)

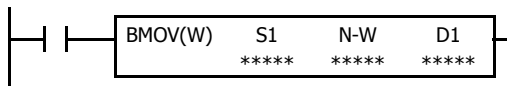

S1, S1+1, S1+2, ... , S1+N-1 → D1, D1+1, D1+2, ... , D1+N-1

When input is on, N blocks of 16-bit word data starting with device assigned by S1 are moved to N blocks of destinations, starting with device assigned by D1. N-W specifies the quantity of blocks to move.

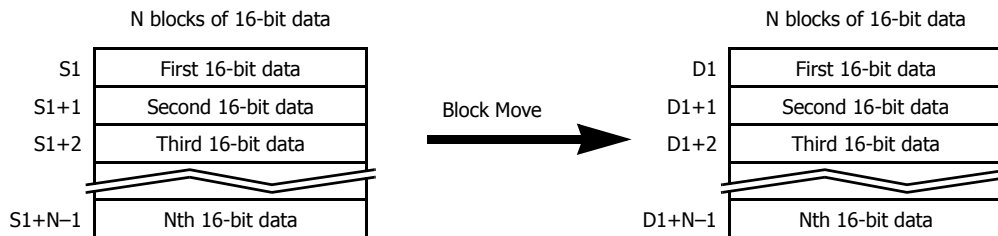

Applicable SmartAXIS

| FT1A-12 | FT1A-24 | FT1A-40 | FT1A-48 | FT1A-Touch |
|---------|---------|---------|---------|------------|
| X | X | X | X | X |

Valid Devices

| Device | Function | I | Q | M | R | T | C | D | Constant | Repeat |
|--------------------|---------------------------------|---|---|---|---|---|---|---|----------|--------|
| S1 (Source 1) | First device address to move | X | X | X | X | X | X | X | — | — |
| N-W (N words) | Quantity of blocks to move | X | X | X | X | X | X | X | X | — |
| D1 (Destination 1) | First device address to move to | — | X | ▲ | X | X | X | X | — | — |

For valid device address ranges, see "Device Addresses" on page 3-1.

▲ Internal relays M0 through M1277 can be designated as D1. Special internal relays cannot be designated as D1.

When T (timer) or C (counter) is used as S1 or N-W, the timer/counter current value (TC or CC) is displayed. When T (timer) or C (counter) is used as D1, the data is written in as a preset value (TP or CP) which can be 0 through 65535.

Make sure that the last source data determined by S1+N-1 and the last destination data determined by D1+N-1 are within the valid device range. If the derived source or destination device exceeds the valid device range, a user program execution error will result, turning on special internal relay M8004 and the ERR LED on the SmartAXIS. For user program execution errors, see "User Program Execution Errors" on page 4-13.

Valid Data Types

| | | |
|------------------------|---|--|
| W (word) | X | When a bit device such as I (input), Q (output), M (internal relay), or R (shift register) is assigned as the source, N-W, or destination, 16 points (word data) are used. |
| I (integer) | — | |
| D (double word) | — | When a word device such as T (timer), C (counter), or D (data register) is assigned as the source, N-W, or destination, 1 point (word data) is used. |
| L (long) | — | |
| F (float) | — | |

Special Internal Relay M8024: BMOV/WSFT Executing Flag

While the BMOV or WSFT is executed, M8024 turns on. When completed, M8024 turns off. If the CPU is powered down while executing BMOV or WSFT, M8024 remains on when the CPU is powered up again.

Example: BMOV

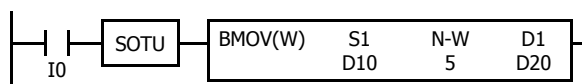

D10 through D14 → D20 through D24

When input I0 is turned on, data of 5 data registers, starting with D10 assigned by source device S1, is moved to 5 data registers starting with D20 assigned by destination device D1.

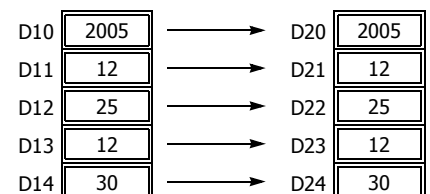

6: MOVE INSTRUCTIONS

IBMV (Indirect Bit Move)

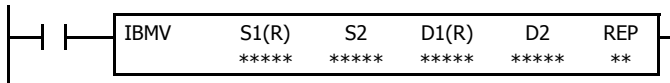

$S1 + S2 \rightarrow D1 + D2$

When input is on, the values contained in devices assigned by S1 and S2 are added together to determine the source of data. The 1-bit data is then moved to the destination, which is determined by the sum of values contained in devices assigned by D1 and D2.

Applicable SmartAXIS

| FT1A-12 | FT1A-24 | FT1A-40 | FT1A-48 | FT1A-Touch |
|---------|---------|---------|---------|------------|
| X | X | X | X | X |

Valid Devices

| Device | Function | I | Q | M | R | T | C | D | Constant | Repeat |
|--------------------|---------------------------|---|---|---|---|---|---|---|----------|--------|
| S1 (Source 1) | Base address to move from | X | X | X | X | — | — | X | 0 or 1 | 1-99 |
| S2 (Source 2) | Offset for S1 | X | X | X | X | X | X | X | 0-65535 | — |
| D1 (Destination 1) | Base address to move to | — | X | ▲ | X | — | — | X | — | 1-99 |
| D2 (Destination 2) | Offset for D1 | X | X | X | X | X | X | X | 0-65535 | — |

For valid device address ranges, see "Device Addresses" on page 3-1.

▲ Internal relays M0 through M1277 can be designated as D1. Special internal relays cannot be designated as D1.

When T (timer) or C (counter) is used as S2 or D2, the timer/counter current value (TC or CC) is displayed.

Make sure that the last source data determined by S1+S2 and the last destination data determined by D1+D2 are within the valid device range. If the derived source or destination device exceeds the valid device range, a user program execution error will result, turning on special internal relay M8004 and ERR LED on the SmartAXIS. For user program execution errors, see "User Program Execution Errors" on page 4-13.

Source device S2 or destination device D2 does not have to be assigned. If S2 or D2 is not assigned, the source or destination device is determined by S1 or D1 without offset.

Examples: IBMV

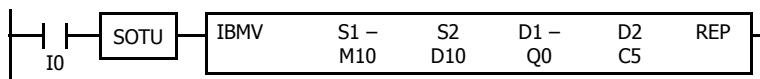

$M10 + D10 \rightarrow Q0 + C5$

Source device S1 and destination device D1 determine the type of device. Source device S2 and destination device D2 are the offset values to determine the source and destination devices.

If the value of data register D10 assigned by source device S2 is 5, the source data is determined by adding the offset value to internal relay M10 assigned by source device S1.

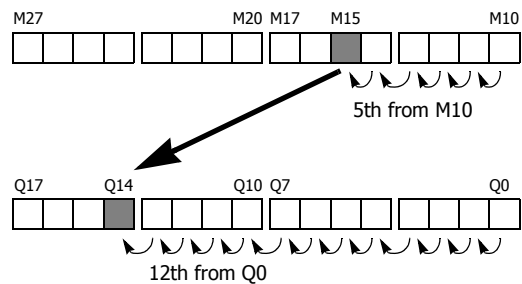

If the current value of counter C5 assigned by destination device D2 is 12, the destination is determined by adding the offset value to output Q0 assigned by destination device D1.

As a result, when input I0 is on, the ON/OFF status of internal relay M15 is moved to output Q14.

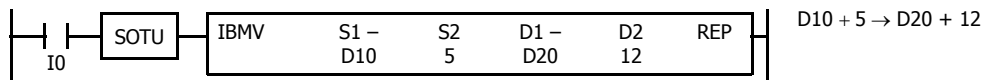

Since source device S1 is a data register and the value of source device S2 is 5, the source data is bit 5 of data register D10 assigned by source device S1.

Since destination device D1 is a data register and the value of source device D2 is 12, the destination is bit 12 of data register D20 assigned by destination device D1.

As a result, when input I0 is on, the ON/OFF status of data register D10 bit 5 is moved to data register D20 bit 12.

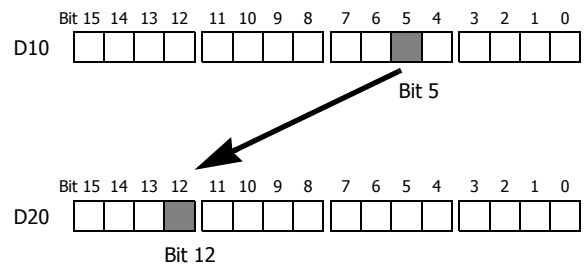

Repeat Operation in the Indirect Bit Move Instructions

Repeat Bit Devices (Source and Destination)

If a repeat operation is set for bit devices such as input, output, internal relay, or shift register, as many bit devices as the repeat cycles are moved.

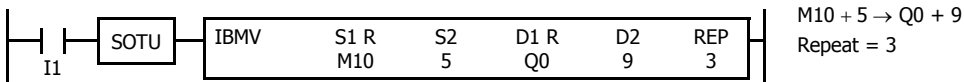

Since source device S1 is internal relay M10 and the value of source device S2 is 5, the source data is 3 internal relays starting with M15.

Since destination device D1 is output Q0 and the value of destination device D2 is 9, the destination is 3 outputs starting with Q11.

As a result, when input I1 is on, the ON/OFF statuses of internal relays M15 through M17 are moved to outputs Q11 through Q13.

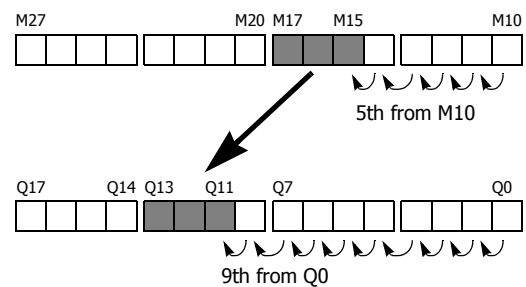

Repeat Word Devices (Source and Destination)

If a repeat operation is for word devices such as data register, as many bit devices as the repeat cycles in the designated data register are moved.

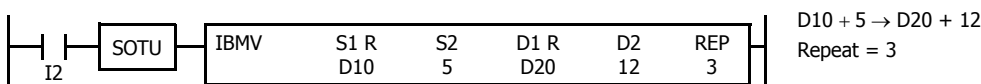

Since source device S1 is data register D10 and the value of source device S2 is 5, the source data is 3 bits starting with bit 5 of data register D10.

Since destination device D1 is data register D20 and the value of destination device D2 is 12, the destination is 3 bits starting with bit 12 of data register D20.

As a result, when input I2 is on, the ON/OFF statuses of data register D10 bits 5 through 7 are moved to data register D20 bits 12 through 14.

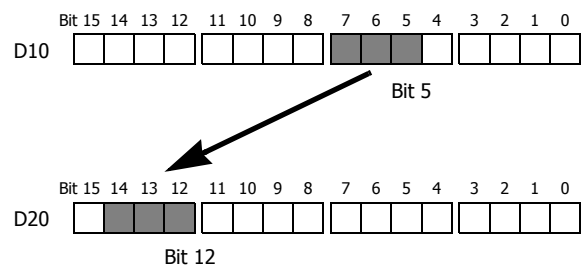

6: MOVE INSTRUCTIONS

IBMVN (Indirect Bit Move Not)

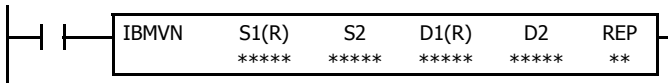

$S1 + S2 \text{ NOT} \rightarrow D1 + D2$

When input is on, the values contained in devices assigned by S1 and S2 are together added to determine the data source. The 1-bit data is then inverted and moved to the destination, which is determined by the sum of values contained in devices assigned by D1 and D2.

Applicable SmartAXIS

| FT1A-12 | FT1A-24 | FT1A-40 | FT1A-48 | FT1A-Touch |
|---------|---------|---------|---------|------------|
| X | X | X | X | X |

Valid Devices

| Device | Function | I | Q | M | R | T | C | D | Constant | Repeat |
|--------------------|---------------------------|---|---|---|---|---|---|---|----------|--------|
| S1 (Source 1) | Base address to move from | X | X | X | X | — | — | X | 0 or 1 | 1-99 |
| S2 (Source 2) | Offset for S1 | X | X | X | X | X | X | X | 0-65535 | — |
| D1 (Destination 1) | Base address to move to | — | X | ▲ | X | — | — | X | — | 1-99 |
| D2 (Destination 2) | Offset for D1 | X | X | X | X | X | X | X | 0-65535 | — |

For valid device address ranges, see "Device Addresses" on page 3-1.

▲ Internal relays M0 through M1277 can be designated as D1. Special internal relays cannot be designated as D1.

When T (timer) or C (counter) is used as S2 or D2, the timer/counter current (TC or CC) value is displayed.

Make sure that the last source data determined by S1+S2 and the last destination data determined by D1+D2 are within the valid device range. If the derived source or destination device exceeds the valid device range, a user program execution error will result, turning on special internal relay M8004 and ERR LED on the SmartAXIS. For user program execution errors, see "User Program Execution Errors" on page 4-13.

Source device S2 or destination device D2 does not have to be used. If S2 or D2 are not used, the source or destination device is determined by S1 or D1 without offset.

Examples: IBMVN

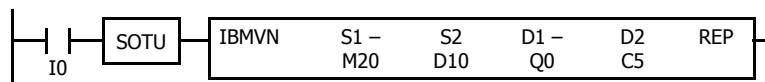

$M20 + D10 \text{ NOT} \rightarrow Q0 + C5$

Source device S1 and destination device D1 determine the type of device. Source device S2 and destination device D2 are the offset values used to determine the source and destination devices.

If the value of data register D10 assigned by source device S2 is 8, the source data is determined by adding the offset value to internal relay M20 assigned by source device S1.

If the current value of counter C5 assigned by destination device D2 is 10, the destination is determined by adding the offset value to output Q0 assigned by destination device D1.

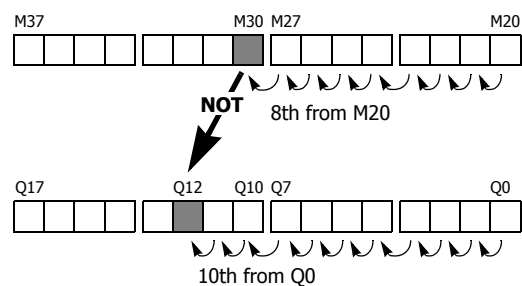

As a result, when input I0 is on, the ON/OFF status of internal relay M30 is inverted and moved to output Q12.

NSET (N Data Set)

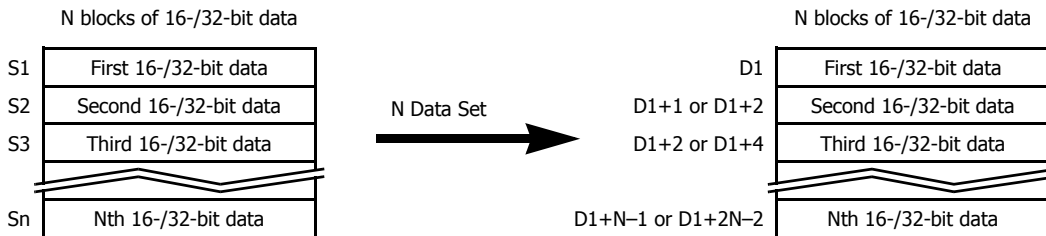
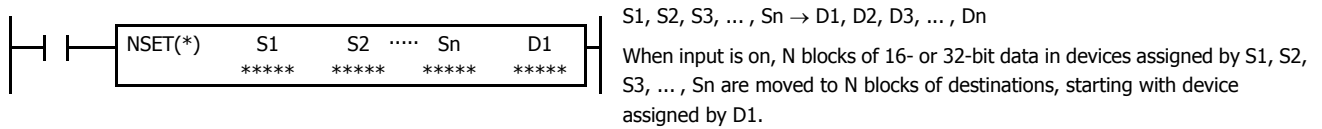

Applicable SmartAXIS

| FT1A-12 | FT1A-24 | FT1A-40 | FT1A-48 | FT1A-Touch |
|---------|---------|---------|---------|------------|
| X | X | X | X | X |

Valid Devices

| Device | Function | I | Q | M | R | T | C | D | Constant | Repeat |
|--------------------|---------------------------------|---|---|---|---|---|---|---|----------|--------|
| S1 (Source 1) | First device address to move | X | X | X | X | X | X | X | X | — |
| D1 (Destination 1) | First device address to move to | — | X | ▲ | X | X | X | X | — | — |

For valid device address ranges, see "Device Addresses" on page 3-1.

▲ Special internal relays cannot be designated as D1.

When T (timer) or C (counter) is used as S1, the timer/counter current value (TC or CC) is displayed. When T (timer) or C (counter) is used as D1, the data is written in as a preset value (TP or CP).

When F (float) data is selected, only data register and constant can be designated as S1, and only data register can be designated as D1.

When F (float) data is selected and S1 does not comply with the normal floating-point format, a user program execution error will result, turning on special internal relay M8004 and ERR LED on the SmartAXIS.

Make sure that the last destination data determined by D1+N-1 (word or integer data) or D1+2N-2 (double-word, long, or float data) is within the valid device range. If the derived destination device exceeds the valid device range, a user program execution error will result, turning on special internal relay M8004 and ERROR LED on the SmartAXIS. For user program execution errors, see "User Program Execution Errors" on page 4-13.

Valid Data Types

| | | |
|------------------------|---|---|
| W (word) | X | When a bit device such as I (input), Q (output), M (internal relay), or R (shift register) is assigned as the source or destination, 16 points (word or integer data) or 32 points (double-word or long data) are used. |
| I (integer) | X | |
| D (double word) | X | When a word device such as T (timer), C (counter), or D (data register) is assigned as the source or destination, 1 point (word or integer data) or 2 points (double-word, long, or float data) are used. |
| L (long) | X | |
| F (float) | X | |

Example: NSET(F)

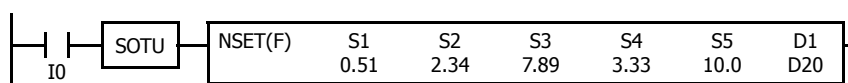

Five constants 0.51, 2.34, 7.89, 3.33, and 10.0 → D20 through D29

When input I0 is turned on, 5 constants assigned by source devices S1 through S5 are moved to 10 data registers starting with D20 assigned by destination device D1.

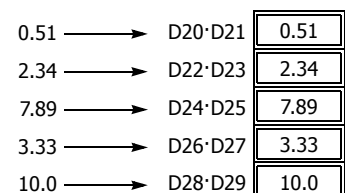

6: MOVE INSTRUCTIONS

NRS (N Data Repeat Set)

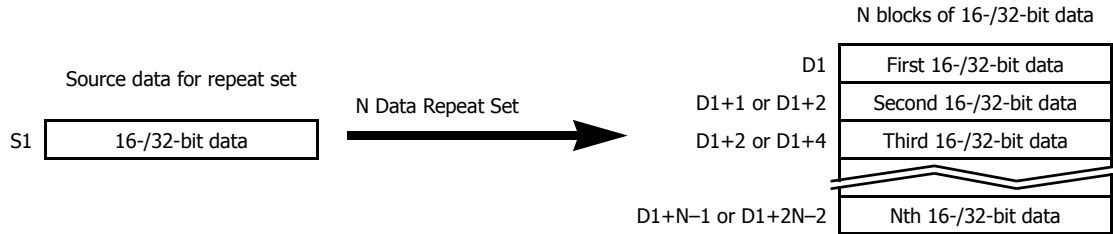
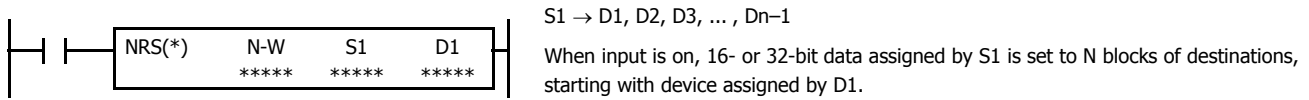

Applicable SmartAXIS

| FT1A-12 | FT1A-24 | FT1A-40 | FT1A-48 | FT1A-Touch |
|---------|---------|---------|---------|------------|
| X | X | X | X | X |

Valid Devices

| Device | Function | I | Q | M | R | T | C | D | Constant | Repeat |
|--------------------|---------------------------------|---|---|---|---|---|---|---|----------|--------|
| N-W (N blocks) | Quantity of blocks to move | X | X | X | X | X | X | X | X | — |
| S1 (Source 1) | First device address to move | X | X | X | X | X | X | X | X | — |
| D1 (Destination 1) | First device address to move to | — | X | ▲ | X | X | X | X | — | — |

For valid device address ranges, see "Device Addresses" on page 3-1.

For the N-W, 1 word (16 bits) is always used without regard to the data type.

▲ Special internal relays cannot be designated as D1.

When T (timer) or C (counter) is used as N-W or S1, the timer/counter current value (TC or CC) is displayed. When T (timer) or C (counter) is used as D1, the data is written in as a preset value (TP or CP).

When F (float) data is selected, only data register and constant can be designated as S1, and only data register can be designated as D1.

When F (float) data is selected and S1 does not comply with the normal floating-point format, a user program execution error will result, turning on special internal relay M8004 and ERR LED on the SmartAXIS.

Make sure that the last destination data determined by D1+N-1 (word or integer data) or D1+2N-2 (double-word, long, or float data) is within the valid device range. If the derived destination device exceeds the valid device range, a user program execution error will result, turning on special internal relay M8004 and ERROR LED on the SmartAXIS. For user program execution errors, see "User Program Execution Errors" on page 4-13.

Valid Data Types

| | | |
|------------------------|---|---|
| W (word) | X | When a bit device such as I (input), Q (output), M (internal relay), or R (shift register) is assigned as the source or destination, 16 points (word or integer data) or 32 points (double-word or long data) are used. |
| I (integer) | X | |
| D (double word) | X | When a word device such as T (timer), C (counter), or D (data register) is assigned as the source or destination, 1 point (word or integer data) or 2 points (double-word, long, or float data) are used. |
| L (long) | X | |
| F (float) | X | |

Example: NRS(F)

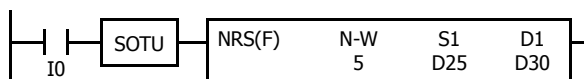

D25·D26 → D30 through D39

When input I0 is turned on, data of data registers D25·D26 assigned by source device S1 is moved to 10 data registers starting with D30 assigned by destination device D1.

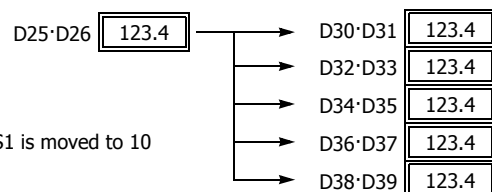

XCHG (Exchange)

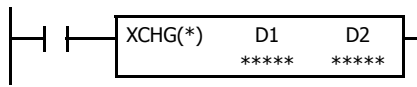

Word data: D1 ↔ D2
 Double-word data: D1·D1+1 → D2, D2+1

When input is on, the 16- or 32-bit data in devices assigned by D1 and D2 are exchanged with each other.

Applicable SmartAXIS

| FT1A-12 | FT1A-24 | FT1A-40 | FT1A-48 | FT1A-Touch |
|---------|---------|---------|---------|------------|
| X | X | X | X | X |

Valid Devices

| Device | Function | I | Q | M | R | T | C | D | Constant | Repeat |
|--------------------|----------------------------------|---|---|---|---|---|---|---|----------|--------|
| D1 (Destination 1) | First device address to exchange | — | X | ▲ | X | — | — | X | — | — |
| D2 (Destination 2) | First device address to exchange | — | X | ▲ | X | — | — | X | — | — |

For valid device address ranges, see "Device Addresses" on page 3-1.

▲ Internal relays M0 through M1277 can be designated as D1 or D2. Special internal relays cannot be designated as D1 or D2.

Valid Data Types

| | |
|------------------------|---|
| W (word) | X |
| I (integer) | — |
| D (double word) | X |
| L (long) | — |
| F (float) | — |

When a bit device such as Q (output), M (internal relay), or R (shift register) is assigned as the destination, 16 points (word data) or 32 points (double-word data) are used.

When a word device such as D (data register) is assigned as the destination, 1 point (word data) or 2 points (double-word data) are used.

Examples: XCHG

• Data Type: Word

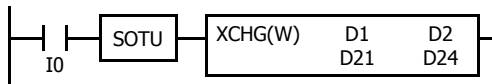

D21 ↔ D24

When input I0 is turned on, data of data registers D21 and D24 assigned by devices D1 and D2 are exchanged with each other.

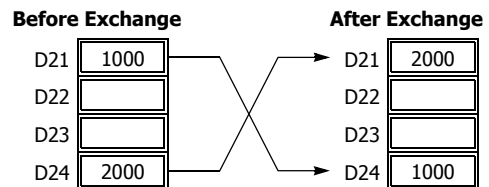

• Data Type: Double Word

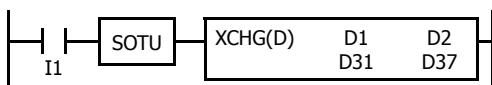

D31·D32 ↔ D37·D38

When input I1 is turned on, data of data registers D31·D32 and D37·D38 assigned by devices D1 and D2 are exchanged with each other.

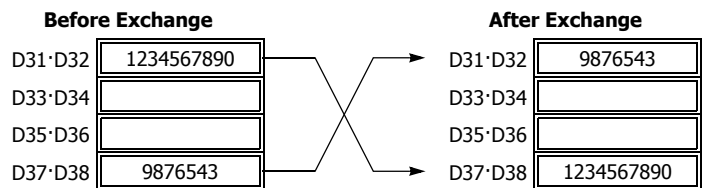

6: MOVE INSTRUCTIONS

TCCST (Timer/Counter Current Value Store)

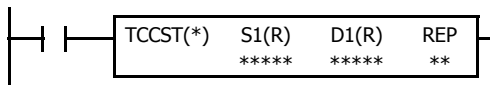

S1 → D1

When input is on, 16- or 32-bit data assigned by S1 is displayed and stored to the current value of device assigned by D1.

Applicable SmartAXIS

| FT1A-12 | FT1A-24 | FT1A-40 | FT1A-48 | FT1A-Touch |
|---------|---------|---------|---------|------------|
| X | X | X | X | X |

Valid Devices

| Device | Function | I | Q | M | R | T | C | D | Constant | Repeat |
|--------------------|---------------------------------|---|---|---|---|---|---|---|----------|--------|
| S1 (Source 1) | First device address to move | X | X | X | X | X | X | X | X | 1-99 |
| D1 (Destination 1) | First device address to move to | — | — | — | — | X | X | — | — | 1-99 |

For valid device address ranges, see "Device Addresses" on page 3-1.

When T (timer) or C (counter) is used as S1, the timer/counter current value (TC or CC) is displayed. T (timer) or C (counter) is used as D1, and the data is written in as a current value (TP or CP).

Since the TCCST instruction is executed in each scan while input is on, a pulse input from a SOTU or SOTD instruction should be used.

Valid Data Types

| | | |
|------------------------|---|--|
| W (word) | X | When a bit device such as I (input), Q (output), M (internal relay), or R (shift register) is assigned as the source, 16 points (word data) or 32 points (double-word data) are used. When repeat is assigned for a bit device, the quantity of device bits increases in 16- or 32-point increments. |
| I (integer) | — | |
| D (double word) | X | |
| L (long) | — | When a word device such as T (timer), C (counter), or D (data register) is assigned as the source or destination, 1 point (word data) or 2 points (double-word data) are used. When repeat is assigned for a word device, the quantity of device words increases in 1- or 2-point increments. |
| F (float) | — | |

Example: TCCST

When input I2 is turned on, 99998 is written to the current value of counter C23.

Ladder Diagram

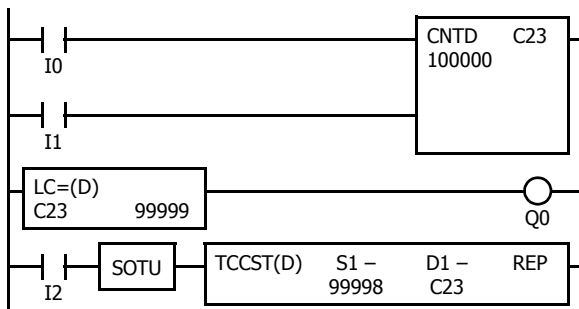

Timing Chart

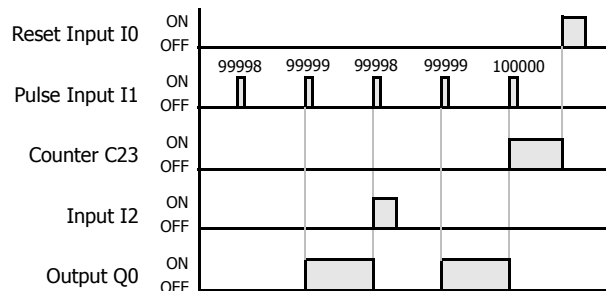

7: DATA COMPARISON INSTRUCTIONS

Introduction

Data can be compared using data comparison instructions, such as equal to, unequal to, less than, greater than, less than or equal to, and greater than or equal to. When the comparison result is true, an output or internal relay is turned on. The repeat operation can also be used to compare more than one set of data.

When the repeat operation is enabled, repeated comparison results of CMP instructions can be selected from AND or OR operation, and the result is outputted to an output or internal relay.

Three values can also be compared using the ICMP>= instruction.

Load comparison instructions load comparison results so that the following instructions can be initiated.

Since the data comparison instructions are executed in each scan while input is on, a pulse input from a SOTU or SOTD instruction should be used.

CMP= (Compare Equal To)

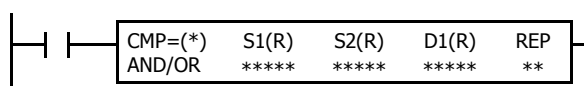

Data type W or I: $S1 = S2 \rightarrow D1$ on
 Data type D, L, or F: $S1 \cdot S1+1 = S2 \cdot S2+1 \rightarrow D1$ on
 When input is on, 16- or 32-bit data assigned by source devices S1 and S2 are compared. When S1 data is equal to S2 data, destination device D1 is turned on. When the condition is not met, D1 is turned off.

CMP<> (Compare Unequal To)

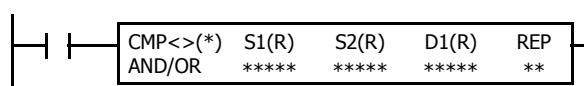

Data type W or I: $S1 \neq S2 \rightarrow D1$ on
 Data type D, L, or F: $S1 \cdot S1+1 \neq S2 \cdot S2+1 \rightarrow D1$ on
 When input is on, 16- or 32-bit data assigned by source devices S1 and S2 are compared. When S1 data is not equal to S2 data, destination device D1 is turned on. When the condition is not met, D1 is turned off.

CMP< (Compare Less Than)

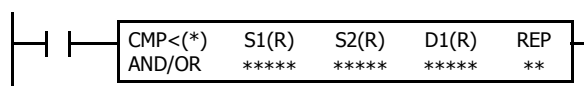

Data type W or I: $S1 < S2 \rightarrow D1$ on
 Data type D, L, or F: $S1 \cdot S1+1 < S2 \cdot S2+1 \rightarrow D1$ on
 When input is on, 16- or 32-bit data assigned by source devices S1 and S2 are compared. When S1 data is less than S2 data, destination device D1 is turned on. When the condition is not met, D1 is turned off.

CMP> (Compare Greater Than)

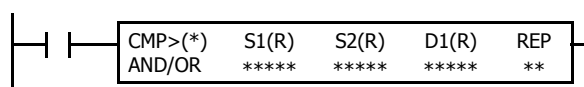

Data type W or I: $S1 > S2 \rightarrow D1$ on
 Data type D, L, or F: $S1 \cdot S1+1 > S2 \cdot S2+1 \rightarrow D1$ on
 When input is on, 16- or 32-bit data assigned by source devices S1 and S2 are compared. When S1 data is greater than S2 data, destination device D1 is turned on. When the condition is not met, D1 is turned off.

CMP<= (Compare Less Than or Equal To)

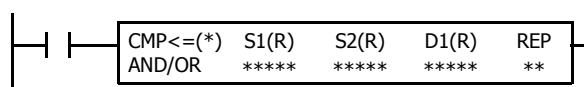

Data type W or I: $S1 \leq S2 \rightarrow D1$ on
 Data type D, L, or F: $S1 \cdot S1+1 \leq S2 \cdot S2+1 \rightarrow D1$ on
 When input is on, 16- or 32-bit data assigned by source devices S1 and S2 are compared. When S1 data is less than or equal to S2 data, destination device D1 is turned on. When the condition is not met, D1 is turned off.

CMP>= (Compare Greater Than or Equal To)

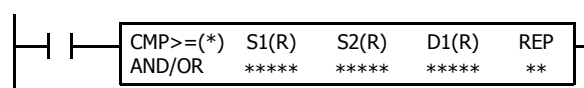

Data type W or I: $S1 \geq S2 \rightarrow D1$ on
 Data type D, L, or F: $S1 \cdot S1+1 \geq S2 \cdot S2+1 \rightarrow D1$ on
 When input is on, 16- or 32-bit data assigned by source devices S1 and S2 are compared. When S1 data is greater than or equal to S2 data, destination device D1 is turned on. When the condition is not met, D1 is turned off.

7: DATA COMPARISON INSTRUCTIONS

Applicable SmartAXIS

| FT1A-12 | FT1A-24 | FT1A-40 | FT1A-48 | FT1A-Touch |
|---------|---------|---------|---------|------------|
| X | X | X | X | X |

Valid Devices

| Device | Function | I | Q | M | R | T | C | D | Constant | Repeat |
|--------------------|-----------------------------|---|---|---|---|---|---|---|----------|--------|
| Repeat Result | Logical AND or OR operation | — | — | — | — | — | — | — | — | — |
| S1 (Source 1) | Data to compare | X | X | X | X | X | X | X | X | 1-99 |
| S2 (Source 2) | Data to compare | X | X | X | X | X | X | X | X | 1-99 |
| D1 (Destination 1) | Comparison output | — | X | ▲ | — | — | — | — | — | 1-99 |

For valid device address ranges, see "Device Addresses" on page 3-1.

When only S1 and/or S2 is repeated, the logical operation type can be selected from AND or OR.

▲ Internal relays M0 through M1277 can be designated as D1. Special internal relays cannot be designated as D1.

When T (timer) or C (counter) is used as S1 or S2, the timer/counter current value (TC or CC) is displayed.

When F (float) data is selected, only data register and constant can be designated as S1 and S2.

When F (float) data is selected and S1 or S2 does not comply with the normal floating-point format, a user program execution error will result, turning on special internal relay M8004 and ERR LED on the SmartAXIS. For user program execution errors, see "User Program Execution Errors" on page 4-13.

Valid Data Types

| | |
|------------------------|---|
| W (word) | X |
| I (integer) | X |
| D (double word) | X |
| L (long) | X |
| F (float) | X |

When a bit device such as I (input), Q (output), M (internal relay), or R (shift register) is assigned as the source, 16 points (word or integer data) or 32 points (double-word or long data) are used. When repeat is assigned for a bit device, the quantity of device bits increases in 16- or 32-point increments.

When a word device such as T (timer), C (counter), or D (data register) is assigned as the source, 1 point (word or integer data) or 2 points (double-word, long, or float data) are used. When repeat is assigned for a word device, the quantity of device words increases in 1- or 2-point increments.

When an output or internal relay is assigned as the destination, only 1 point is used regardless of the selected data type. When repeat is assigned for the destination, outputs or internal relays as many as the repeat cycles are used.

Special Internal Relays M8150, M8151, and M8152 in CMP=

Three special internal relays are available to indicate the comparison result of the CMP= instruction. Depending on the result, one of the three special internal relays turns on.

When $S1 > S2$, M8150 turns on.

When $S1 = S2$, M8151 turns on.

When $S1 < S2$, M8152 turns on.

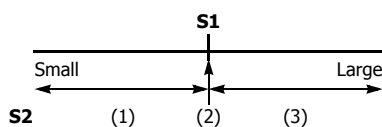

| S2 Value | M8150 | M8151 | M8152 | D1 Status |
|---------------|-----------|-----------|-----------|-----------|
| (1) $S1 > S2$ | ON | OFF | OFF | OFF |
| (2) $S1 = S2$ | OFF | ON | OFF | ON |
| (3) $S1 < S2$ | OFF | OFF | ON | OFF |

When repeat is designated, the comparison result of the last repeat cycle turns on one of the three special internal relays.

When more than one CMP = or ICMP>= instruction is used, M8150, M8151, or M8152 indicates the result of the instruction that was executed last.

Examples: CMP>=

The following examples are described using the CMP≥ instruction. Data comparison operation for all other data comparison instructions is the same for the CMP≥ instruction.

• Data Type: Word

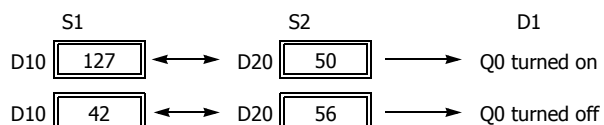
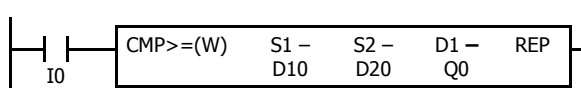

• Data Type: Integer

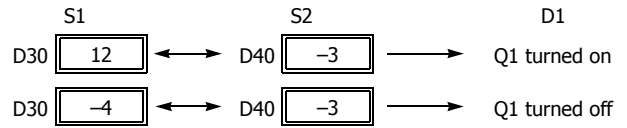
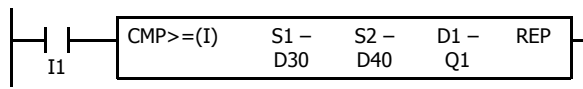

• Data Type: Double Word

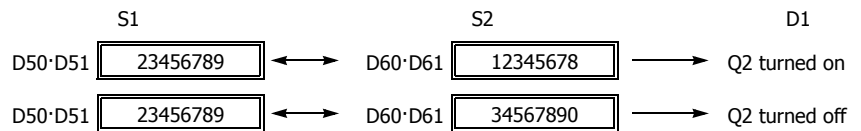
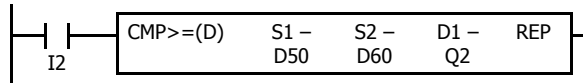

• Data Type: Long

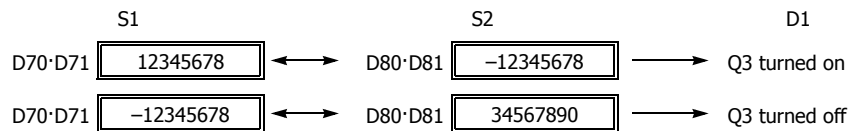
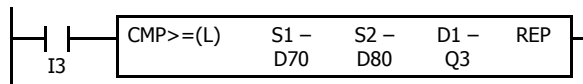

• Data Type: Float

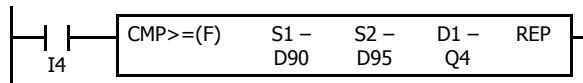

Repeat Operation in the Data Comparison Instructions

The following examples use the CMP \geq instruction of word and double word data. Repeat operation for all other data comparison instructions and other data types is the same as the following examples.

When the repeat operation is enabled, repeated comparison results of CMP instructions can be selected from AND or OR operation, and the result is output to an output or internal relay.

Repeat One Source Device

When only S1 (source) is designated to repeat, source devices (as many as the repeat cycles, starting with the device designated by S1) are compared with the device designated by S2. The comparison results are ANDed or ORed and set to the destination device designated by D1.

• **Data Type: Word (Repeat Logical Operation AND)**

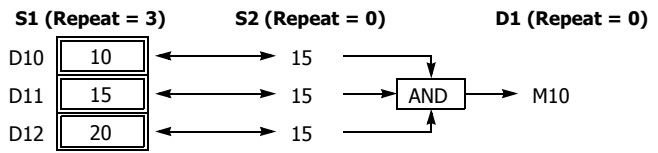
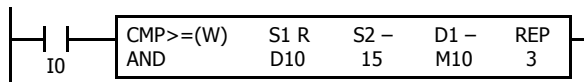

• **Data Type: Word (Repeat Logical Operation OR)**

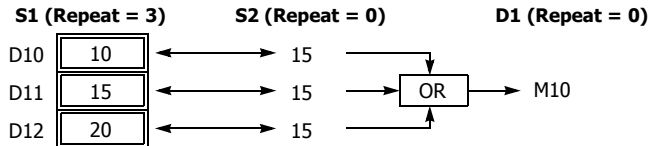
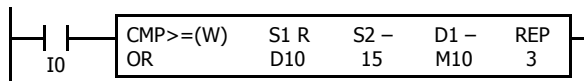

• **Data Type: Double Word (Repeat Logical Operation AND)**

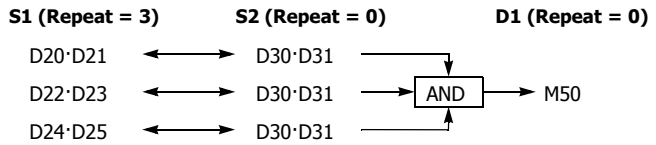
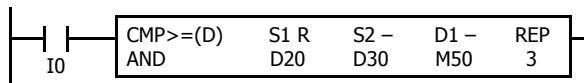

Repeat Two Source Devices

When S1 (source) and S2 (source) are designated to repeat, source devices (as many as the repeat cycles, starting with the devices designated by S1 and S2) are compared with each other. The comparison results are ANDed or ORed and set to the destination device designated by D1.

• **Data Type: Word (Repeat Logical Operation AND)**

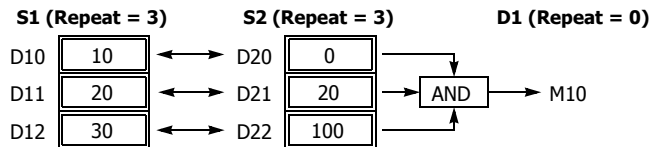
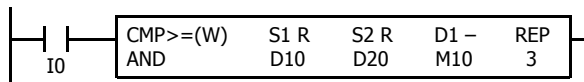

• **Data Type: Word (Repeat Logical Operation OR)**

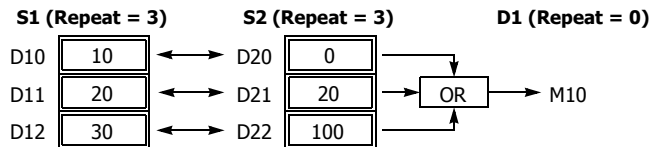
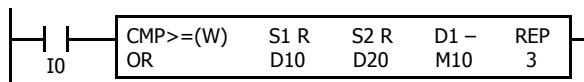

• **Data Type: Double Word (Repeat Logical Operation AND)**

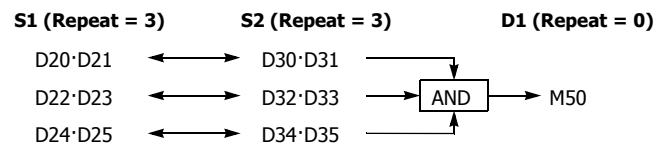
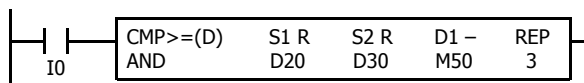

Repeat Source and Destination Devices

When S1, S2 (source), and D1 (destination) are designated to repeat, source devices (as many as the repeat cycles, starting with the devices designated by S1 and S2) are compared with each other. The comparison results are set to destination devices (as many as the repeat cycles, starting with the device designated by D1).

- **Data Type: Word**

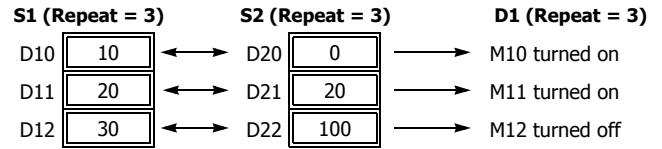
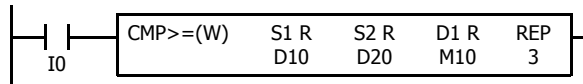

- **Data Type: Double Word**

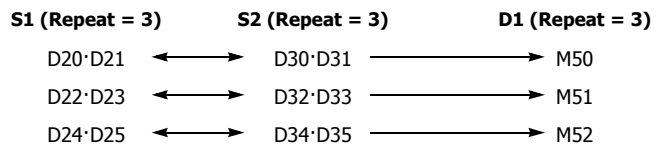
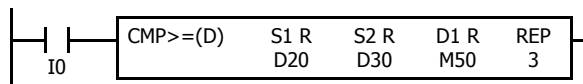

Comparison Output Status

The comparison output is usually maintained while the input to the data comparison instruction is off. If the comparison output is on, the on status is maintained when the input is turned off as demonstrated by this program.

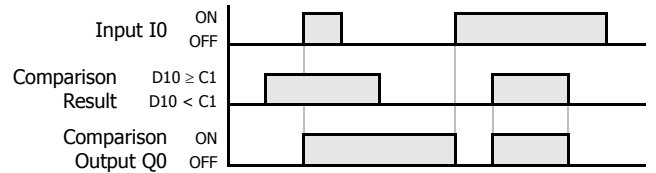
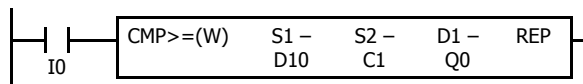

This program turns the output off when the input is off.

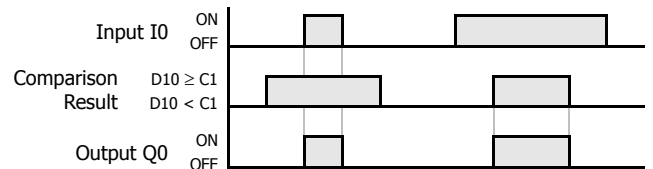
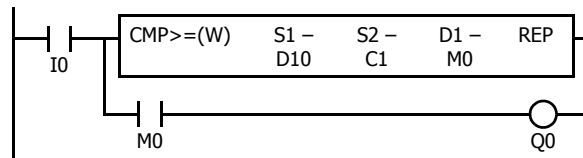

7: DATA COMPARISON INSTRUCTIONS

ICMP>= (Interval Compare Greater Than or Equal To)

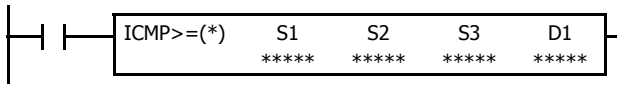

Data type W or I: $S1 \geq S2 \geq S3 \rightarrow D1$ on
 Data type D, L, F: $S1 \cdot S1+1 \geq S2 \cdot S2+1 \geq S3 \cdot S3+1 \rightarrow D1$ on
 When input is on, the 16- or 32-bit data assigned by S1, S2, and S3 are compared. When the condition is met, destination device D1 is turned on. When the condition is not met, D1 is turned off.

Applicable SmartAXIS

| FT1A-12 | FT1A-24 | FT1A-40 | FT1A-48 | FT1A-Touch |
|---------|---------|---------|---------|------------|
| X | X | X | X | X |

Valid Devices

| Device | Function | I | Q | M | R | T | C | D | Constant | Repeat |
|--------------------|-------------------|---|---|---|---|---|---|---|----------|--------|
| S1 (Source 1) | Data to compare | X | X | X | X | X | X | X | X | — |
| S2 (Source 2) | Data to compare | X | X | X | X | X | X | X | X | — |
| S3 (Source 3) | Data to compare | X | X | X | X | X | X | X | X | — |
| D1 (Destination 1) | Comparison output | — | X | ▲ | — | — | — | — | — | — |

For the valid device address range, see "Device Addresses" on page 3-1.

▲ Internal relays M0 through M1277 can be designated as D1. Special internal relays cannot be designated as D1.

When T (timer) or C (counter) is used as S1, S2, or S3, the timer/counter current value (TC or CC) is displayed.

When F (float) data is selected, only data register and constant can be designated as S1, S2, and S3.

When F (float) data is selected and S1, S2, or S3 does not comply with the normal floating-point format, a user program execution error will result, turning on special internal relay M8004 and ERR LED on the SmartAXIS.

When the data of S1 is smaller than that of S3 ($S1 < S3$), a user program execution error will result, turning on special internal relay M8004 and ERR LED on the SmartAXIS. For user program execution errors, see "User Program Execution Errors" on page 4-13.

| | | |
|------------------------|---|--|
| W (word) | X | When a bit device such as I (input), Q (output), M (internal relay), or R (shift register) is assigned as the source, 16 points (word or integer data) or 32 points (double-word or long data) are used. |
| I (integer) | X | |
| D (double word) | X | When a word device such as T (timer), C (counter), or D (data register) is assigned as the source, 1 point (word or integer data) or 2 points (double-word, long, or float data) are used. |
| L (long) | X | |
| F (float) | X | The destination uses only one output or internal relay regardless of the selected data type. |

Special Internal Relays M8150, M8151, and M8152 in ICMP>=

Three special internal relays are available to indicate the comparison result of the ICMP>= instruction. Depending on the result, one of the three special internal relays turns on. S1 must always be greater than or equal to S3 ($S1 \geq S3$).

When $S2 > S1$, M8150 turns on.

When $S2 < S3$, M8151 turns on.

When $S1 > S2 > S3$, M8152 turns on.

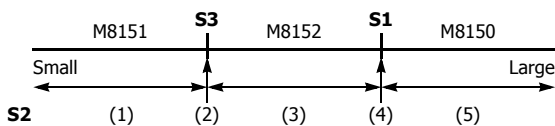

| S2 Value | M8150 | M8151 | M8152 | D1 Status |
|--------------------|-----------|-----------|-----------|-----------|
| (1) $S2 < S3$ | OFF | ON | OFF | OFF |
| (2) $S2 = S3$ | OFF | OFF | OFF | ON |
| (3) $S3 < S2 < S1$ | OFF | OFF | ON | ON |
| (4) $S2 = S1$ | OFF | OFF | OFF | ON |
| (5) $S2 > S1$ | ON | OFF | OFF | OFF |

When more than one ICMP>= or CMP= instruction is used, M8150, M8151, or M8152 indicates the result of the instruction that was executed last.

Example: ICMP>=

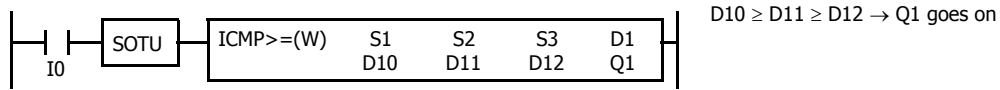

When input I0 is turned on, data of data registers D10, D11, and D12 assigned by source devices S1, S2, and S3 are compared. When the condition is met, internal relay Q1 assigned by destination device D1 is turned on. When the condition is not met, Q1 is turned off.

| | | | | | | | | | | | | | |
|-----|--|---|-----|--|----|-----|--|-------|-------------|-------|-------|-----|-----|
| | S1 | | S2 | | S3 | | D1 | M8150 | M8151 | M8152 | M8004 | | |
| D10 | 17 | > | D11 | 15 | = | D12 | 15 | → | Q1 goes on | OFF | OFF | OFF | OFF |
| D10 | 15 | < | D11 | 18 | < | D12 | 19 | → | Q1 goes off | ON | ON | OFF | ON |

7: DATA COMPARISON INSTRUCTIONS

LC= (Load Compare Equal To)

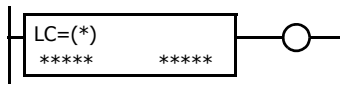

Data type W or I: $S1 = S2$
 Data type D, L, or F: $S1 \cdot S1+1 = S2 \cdot S2+1$
 This instruction constantly compares 16- or 32- bit data assigned by S1 and S2. When S1 data is equal to S2 data, the output to the following instructions is turned on. When the condition is not met, the output is turned off.

LC<> (Load Compare Unequal To)



Data type W or I: $S1 \neq S2$
 Data type D, L, or F: $S1 \cdot S1+1 \neq S2 \cdot S2+1$
 This instruction constantly compares 16- or 32- bit data assigned by S1 and S2. When S1 data is not equal to S2 data, the output to the following instructions is turned on. When the condition is not met, the output is turned off.

LC< (Load Compare Less Than)

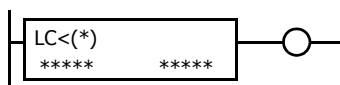

Data type W or I: $S1 < S2$
 Data type D, L, or F: $S1 \cdot S1+1 < S2 \cdot S2+1$
 This instruction constantly compares 16- or 32- bit data assigned by S1 and S2. When S1 data is less than S2 data, the output to the following instructions is turned on. When the condition is not met, the output is turned off.

LC> (Load Compare Greater Than)

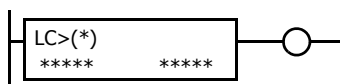

Data type W or I: $S1 > S2$
 Data type D, L, or F: $S1 \cdot S1+1 > S2 \cdot S2+1$
 This instruction constantly compares 16- or 32- bit data assigned by S1 and S2. When S1 data is greater than S2 data, the output to the following instructions is turned on. When the condition is not met, the output is turned off.

LC<= (Load Compare Less Than or Equal To)



Data type W or I: $S1 \leq S2$
 Data type D, L, or F: $S1 \cdot S1+1 \leq S2 \cdot S2+1$
 This instruction constantly compares 16- or 32- bit data assigned by S1 and S2. When S1 data is less than or equal to S2 data, the output to the following instructions is turned on. When the condition is not met, the output is turned off.

LC>= (Load Compare Greater Than or Equal To)

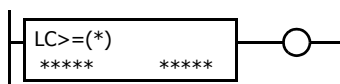

Data type W or I: $S1 \geq S2$
 Data type D, L, or F: $S1 \cdot S1+1 \geq S2 \cdot S2+1$
 This instruction constantly compares 16- or 32- bit data assigned by S1 and S2. When S1 data is greater than or equal to S2 data, the output to the following instructions is turned on. When the condition is not met, the output is turned off.

Applicable SmartAXIS

| FT1A-12 | FT1A-24 | FT1A-40 | FT1A-48 | FT1A-Touch |
|---------|---------|---------|---------|------------|
| X | X | X | X | X |

Valid Devices

| Device | Function | I | Q | M | R | T | C | D | Constant | Repeat |
|---------------|-----------------|---|---|---|---|---|---|---|----------|--------|
| S1 (Source 1) | Data to compare | X | X | X | X | X | X | X | X | — |
| S2 (Source 2) | Data to compare | X | X | X | X | X | X | X | X | — |

For valid device address ranges, see "Device Addresses" on page 3-1.

When T (timer) or C (counter) is used, the timer/counter current value (TC or CC) is displayed.

When F (float) data is selected, only data register and constant can be designated.

When F (float) data is selected and S1 or S2 does not comply with the normal floating-point format, a user program execution error will result, turning on special internal relay M8004 and ERR LED on the SmartAXIS. The output to the following instructions is turned off. For user program execution errors, see "User Program Execution Errors" on page 4-13.

Valid Data Types

| | |
|------------------------|---|
| W (word) | X |
| I (integer) | X |
| D (double word) | X |
| L (long) | X |
| F (float) | X |

When a bit device such as I (input), Q (output), M (internal relay), or R (shift register) is assigned, 16 points (word or integer data) or 32 points (double-word or long data) are used.

When a word device such as T (timer), C (counter), or D (data register) is assigned, 1 point (word or integer data) or 2 points (double-word, long, or float data) are used.

Examples: LC

Ladder Diagram 1

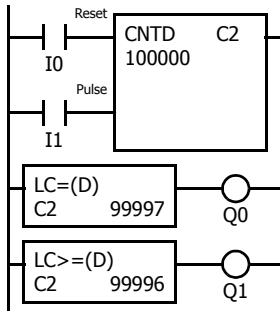

Program List

| Instruction | Data |
|-------------|--------|
| LOD | I0 |
| LOD | I1 |
| CNTD | C2 |
| | 100000 |
| LC=(D) | C2 |
| | 99997 |
| OUT | Q0 |
| LC>=(D) | C2 |
| | 99996 |
| OUT | Q1 |

Timing Chart

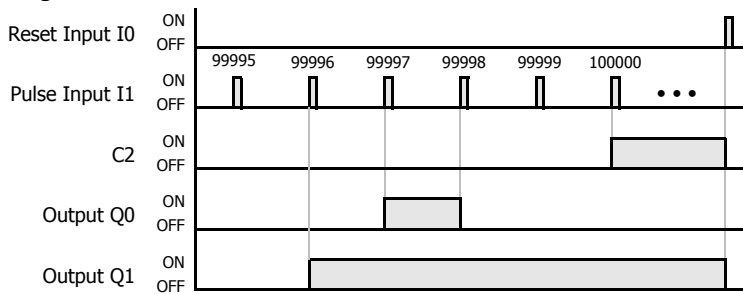

Output Q0 is on when counter C2 current value is 99997.

Output Q1 is turned on when counter C2 current value reaches 99996 and remains on until counter C2 is reset.

Ladder Diagram 2

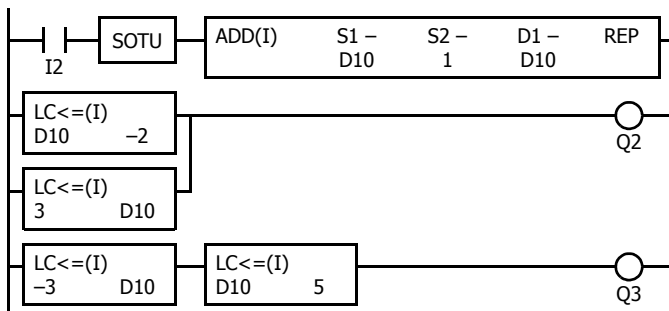

Program List

| Instruction | Data |
|-------------|------|
| LOD | I2 |
| SOTU | |
| ADD(I) | D10 |
| | 1 |
| | D10 |
| LC<=(I) | D10 |
| | -2 |
| LC<=(I) | D10 |
| | 3 |
| | D10 |
| ORLOD | |
| OUT | Q2 |
| LC<=(I) | D10 |
| | -3 |
| LC<=(I) | D10 |
| | 5 |
| ANDLOD | |
| OUT | Q3 |

Timing Chart

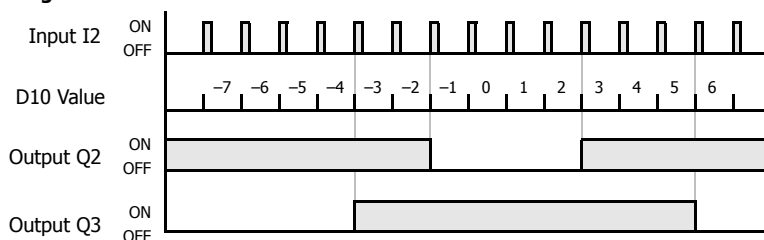

Output Q2 is on when data register D10 is less than or equal to -2 and greater than or equal to 3.

Output Q3 is on while data register D10 is between -3 and 5.

8: BINARY ARITHMETIC INSTRUCTIONS

Introduction

The binary arithmetic instructions make it possible for the user to program computations using addition, subtraction, multiplication, and division. For addition and subtraction devices, internal relay M8003 is used to carry or to borrow.

The ROOT instruction can be used to calculate the square root of the value stored in one or two data registers.

ADD (Addition)

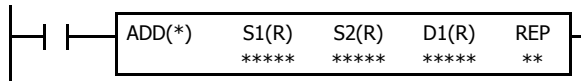

Data type W or I: $S1 + S2 \rightarrow D1, CY$
 Data type D, L, or F: $S1 \cdot S1+1 + S2 \cdot S2+1 \rightarrow D1 \cdot D1+1, CY$

When input is on, 16- or 32-bit data assigned by source devices S1 and S2 are added together. The result is set to destination device D1 and internal relay M8003 (carry or borrow).

SUB (Subtraction)

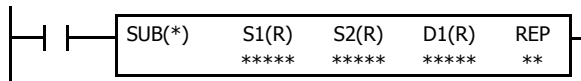

Data type W or I: $S1 - S2 \rightarrow D1, BW$
 Data type D, L, or F: $S1 \cdot S1+1 - S2 \cdot S2+1 \rightarrow D1 \cdot D1+1, BW$

When input is on, 16- or 32-bit data assigned by source device S2 is subtracted from 16- or 32-bit data assigned by source device S1. The result is set to destination device D1 and internal relay M8003 (carry or borrow).

MUL (Multiplication)

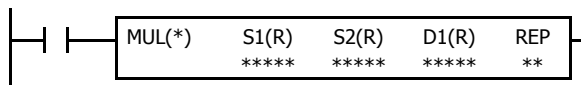

Data type W or I: $S1 \times S2 \rightarrow D1 \cdot D1+1$
 Data type D, L, or F: $S1 \cdot S1+1 \times S2 \cdot S2+1 \rightarrow D1 \cdot D1+1$

When input is on, 16- or 32-bit data assigned by source device S1 is multiplied by 16- or 32-bit data assigned by source device S2. The result is set to destination device D1.

When the result exceeds the valid range for data types D or L, the ERR LED and special internal relay M8004 (user program execution error) are turned on.

DIV (Division)

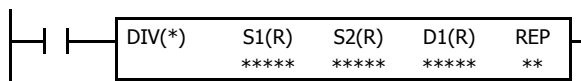

Data type W or I: $S1 \div S2 \rightarrow D1$ (quotient), D1+1 (remainder)
 Data type D or L: $S1 \cdot S1+1 \div S2 \cdot S2+1 \rightarrow D1 \cdot D1+1$ (quotient),
 D1+2·D1+3 (remainder)
 Data type F: $S1 \cdot S1+1 \div S2 \cdot S2+1 \rightarrow D1 \cdot D1+1$ (quotient)

When input is on, 16- or 32-bit data assigned by source device S1 is divided by 16- or 32-bit data assigned by source device S2. The quotient is set to 16- or 32-bit destination device D1, and the remainder is set to the next 16- or 32-bit data. Data type F does not generate a remainder.

When S2 is 0 (dividing by 0), the ERR LED and special internal relay M8004 (user program execution error) are turned on.

A user program execution error also occurs in the following division operations.

Data type I: $-32768 \div (-1)$
 Data type L: $-2147483648 \div (-1)$

8: BINARY ARITHMETIC INSTRUCTIONS

Applicable SmartAXIS

| FT1A-12 | FT1A-24 | FT1A-40 | FT1A-48 | FT1A-Touch |
|---------|---------|---------|---------|------------|
| X | X | X | X | X |

Valid Devices

| Device | Function | I | Q | M | R | T | C | D | Constant | Repeat |
|--------------------|------------------------------|---|---|---|---|---|---|---|----------|--------|
| S1 (Source 1) | Data for calculation | X | X | X | X | X | X | X | X | 1-99 |
| S2 (Source 2) | Data for calculation | X | X | X | X | X | X | X | X | 1-99 |
| D1 (Destination 1) | Destination to store results | — | X | ▲ | X | X | X | X | — | 1-99 |

For valid device address ranges, see "Device Addresses" on page 3-1.

▲ Internal relays M0 through M1277 can be designated as D1. Special internal relays cannot be designated as D1.

When T (timer) or C (counter) is used as S1 or S2, the timer/counter current value (TC or CC) is displayed. When T (timer) or C (counter) is used as D1, the data is written in as a preset value (TP or CP) which can be 0 through 65535.

When F (float) data is selected, only data register and constant can be designated as S1 and S2.

When F (float) data is selected and S1 or S2 does not comply with the normal floating-point format, a user program execution error will result, turning on special internal relay M8004 and ERR LED on the SmartAXIS. For user program execution errors, see "User Program Execution Errors" on page 4-13.

Since the binary arithmetic instructions are executed in each scan while input is on, a pulse input from a SOTU or SOTD instruction should be used.

Valid Data Types

| | | |
|------------------------|---|---|
| W (word) | X | When a bit device such as I (input), Q (output), M (internal relay), or R (shift register) is assigned as the source, 16 points (word or integer data) or 32 points (double-word, long, or float data) are used. When repeat is assigned for a bit device, the quantity of device bits increases in 16- or 32-point increments. |
| I (integer) | X | |
| D (double word) | X | |
| L (long) | X | When a word device such as T (timer), C (counter), or D (data register) is assigned as the source, 1 point (word or integer data) or 2 points (double-word, long, or float data) are used. When repeat is assigned for a word device, the quantity of device words increases in 1- or 2-point increments. |
| F (float) | X | |

Using Carry or Borrow Signals

When the D1 (destination) data exceeds the valid data range as a result of any binary arithmetic operation, a carry or borrow occurs, and special internal relay M8003 is turned on.

| Data Type | Carry/borrow occurs when D1 exceeds the range between |
|------------------------|--|
| W (word) | 0 and 65,535 |
| I (integer) | -32,768 and 32,767 |
| D (double word) | 0 and 4,294,967,295 |
| L (long) | -2,147,483,648 and 2,147,483,647 |
| F (float) | -3.402823×10 ³⁸ and -1.175495×10 ⁻³⁸ 1.175495×10 ⁻³⁸ and 3.402823×10 ³⁸ |

Examples: ADD

• **Data Type: Word**

This example demonstrates the use of a carry signal from special internal relay M8003 to set an alarm signal.

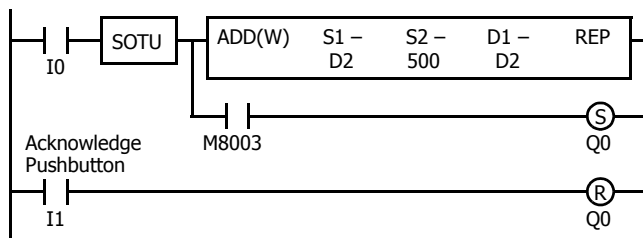

D2 + 500 → D2

When a carry occurs, output Q0 is assigned as a warning indicator.

When the acknowledge pushbutton (input I1) is pressed, the warning indicator is reset.

• **Data Type: Integer**

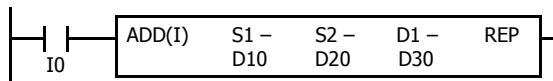

D10 -4 + D20 -11 → D30 -15

• **Data Type: Double Word**

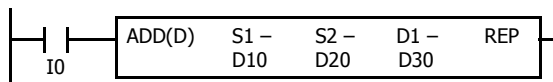

D10·D11 1957400 + D20·D21 4112600 → D30·D31 6070000

• **Data Type: Long**

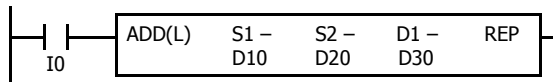

D10·D11 216283 + D20·D21 -964355 → D30·D31 -748072

• **Data Type: Float**

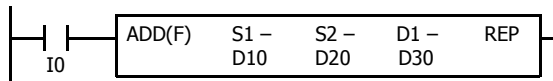

D10·D11 1.414 + D20·D21 3.14 → D30·D31 4.554

Example: SUB

• **Data Type: Word**

The following example demonstrates the use of special internal relay M8003 to process a borrow.

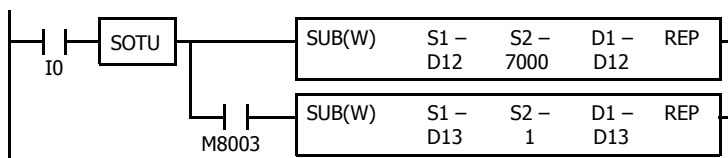

D12 - 7000 → D12

Borrow is processed so that the number of times a borrow occurs is subtracted from D13.

When a borrow occurs, D13 is decremented by one.

Examples: MUL

• Data Type: Word

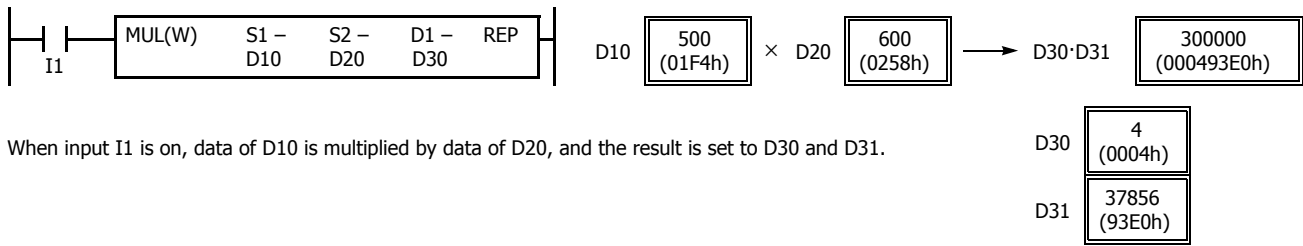

• Data Type: Integer

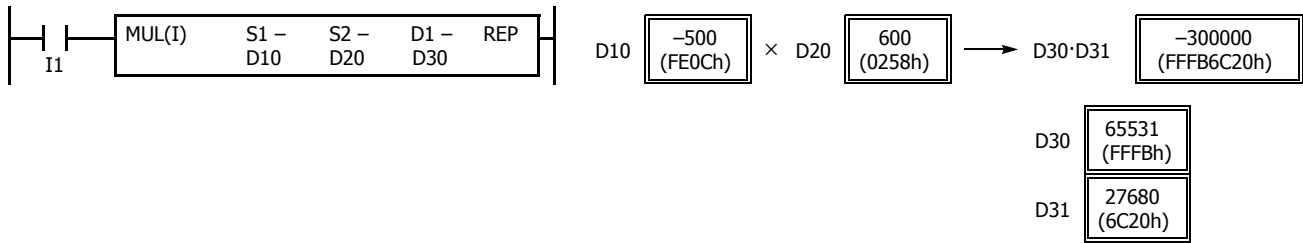

• Data Type: Double Word

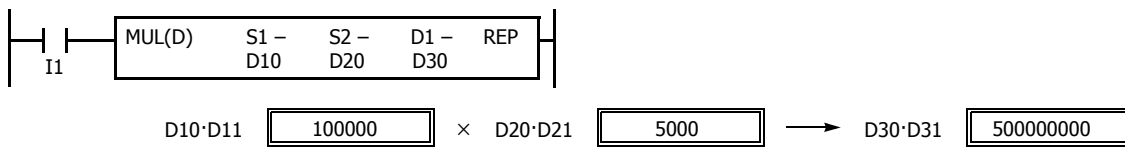

Note: In multiplication of double word data, the lower 32-bit data of the result is set to destination device D1·D1+1.

• Data Type: Long

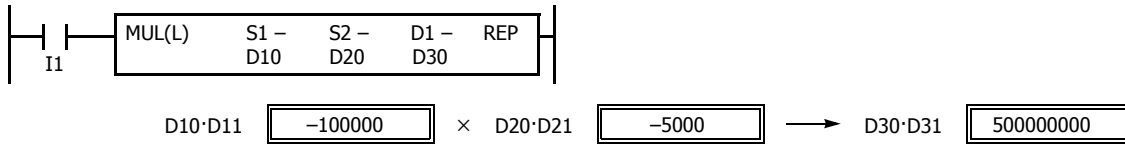

Note: In multiplication of long data, the lower 32-bit data of the result is set to destination device D1·D1+1.

• Data Type: Float

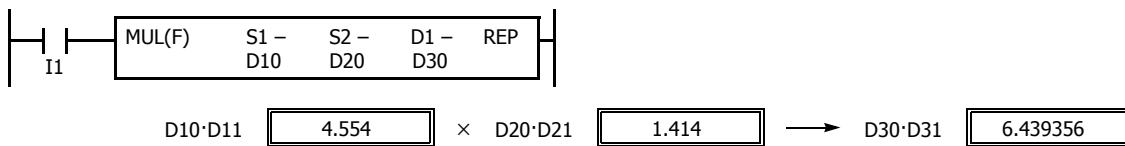

Note: Since the destination uses two word devices in the multiplication operation, data register D999 or D1999 cannot be used as destination device D1. When using a bit device such as internal relay for destination, 32 internal relays are required; so internal relay M1241 or a larger number cannot be used as destination device D1.

Examples: DIV

• **Data Type: Word**

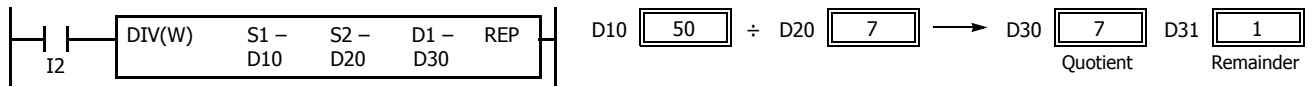

When input I2 is on, D10 data is divided by D20 data. The quotient is set to D30, and the remainder is set to D31.

Note: Since the destination uses two word devices in the division operation of word data, data register D999 or D1999 cannot be used as destination device D1. When using a bit device, such as internal relay for destination, 32 internal relays are required; so M1241 or a larger number cannot be used as destination device D1.

• **Data Type: Integer**

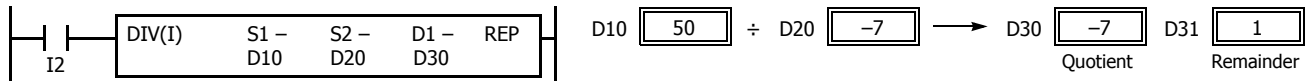

Note: Since the destination uses two word devices in the division operation of integer data, data register D999 or D1999 cannot be used as destination device D1. When using a bit device, such as internal relay for destination, 32 internal relays are required; so M1241 or a larger number cannot be used as destination device D1.

• **Data Type: Double Word**

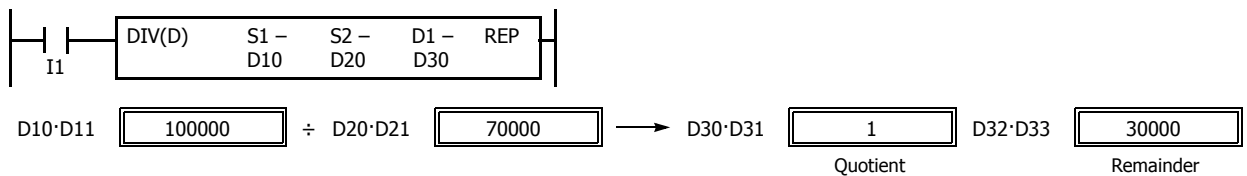

Note: Since the destination uses four word devices in the division operation of double-word data, data registers D997 through D999 or D1997 through D1999 cannot be used as destination device D1. When using a bit device such as internal relay for destination, 64 internal relays are required; so M1201 or a larger number cannot be used as destination device D1.

• **Data Type: Long**

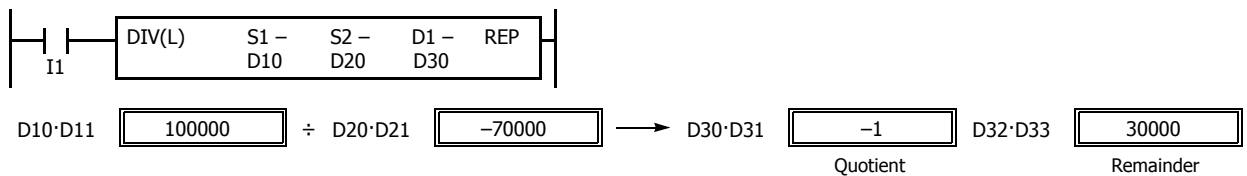

Note: Since the destination uses four word devices in the division operation of long data, data registers D997 through D999 or D1997 through D1999 cannot be used as destination device D1. When using a bit device, such as internal relay for destination, 64 internal relays are required; so M1201 or a larger number cannot be used as destination device D1.

• **Data Type: Float**

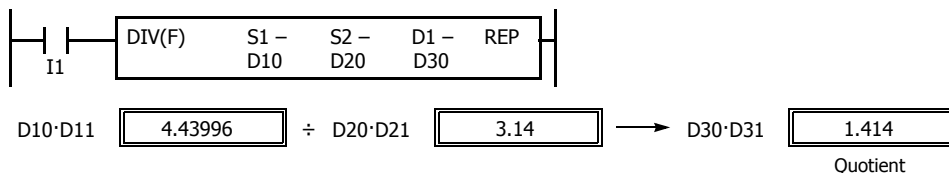

Note: Since the destination uses two word devices in the division operation of float data, data register D999 or D1999 cannot be used as destination device D1.

Repeat Operation in the ADD and SUB Instructions

Source devices S1 and S2 and destination device D1 can be assigned to repeat individually or in combination. When destination device D1 is not set to repeat, the final result is set to destination device D1. When repeat is assigned, as many consecutive devices as the repeat cycles, starting with the designated device, are used. Since the repeat operation works similarly on the ADD (addition) and SUB (subtraction) instructions, the following examples are described using the ADD instruction.

Repeat One Source Device

- **Data Type: Word and Integer**

When only S1 (source) is assigned to repeat, the final result is set to destination device D1.

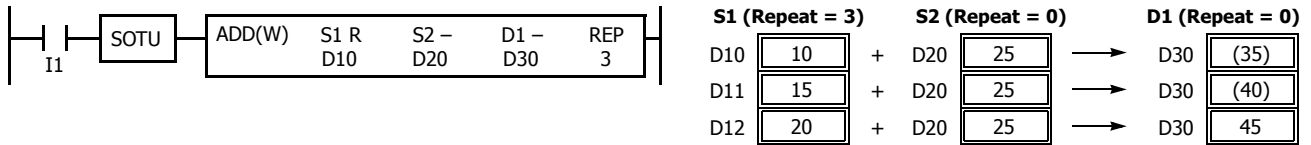

- **Data Type: Double Word, Long, and Float**

When only S1 (source) is assigned to repeat, the final result is set to destination device D1·D1+1.

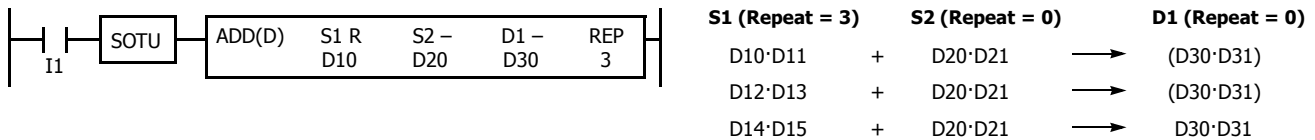

Repeat Destination Device Only

- **Data Type: Word and Integer**

When only D1 (destination) is assigned to repeat, the same result is set to 3 devices starting with D1.

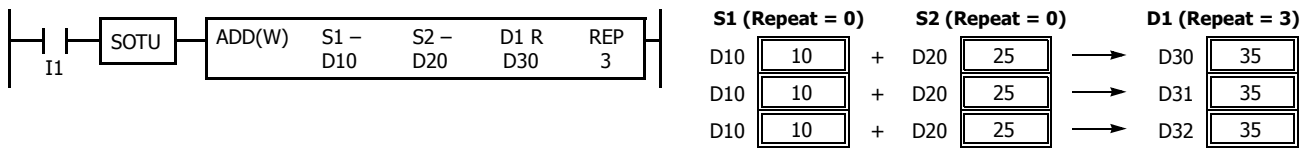

- **Data Type: Double Word, Long, and Float**

When only D1 (destination) is assigned to repeat, the same result is set to 3 devices starting with D1·D1+1.

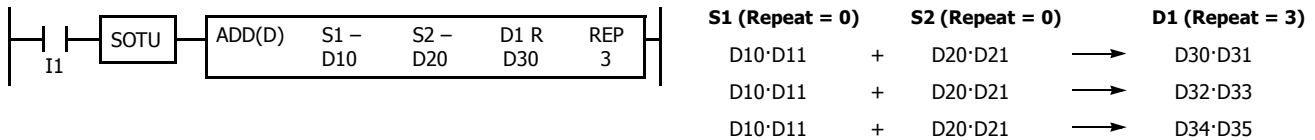

Repeat Two Source Devices

- **Data Type: Word and Integer**

When S1 and S2 (source) are assigned to repeat, the final result is set to destination device D1.

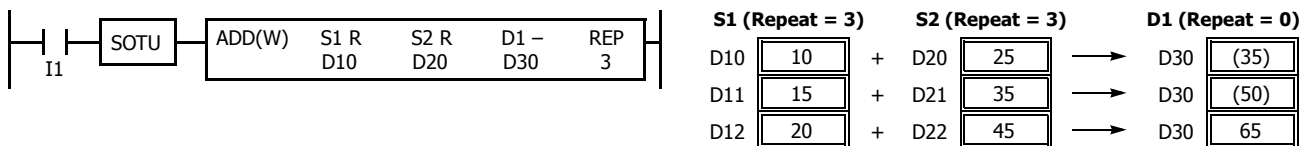

- **Data Type: Double Word, Long, and Float**

When S1 and S2 (source) are assigned to repeat, the final result is set to destination device D1·D1+1.

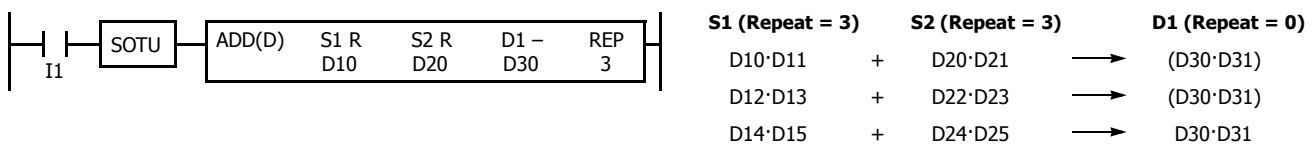

Repeat Source and Destination Devices

- **Data Type: Word and Integer**

When S1 (source) and D1 (destination) are assigned to repeat, different results are set to 3 devices starting with D1.

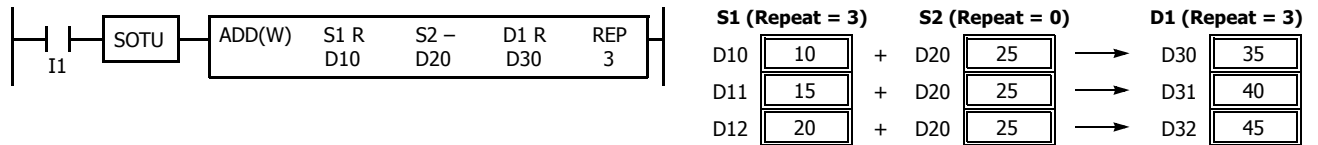

- **Data Type: Double Word, Long, and Float**

When S1 (source) and D1 (destination) are assigned to repeat, different results are set to 3 devices starting with D1·D1+1.

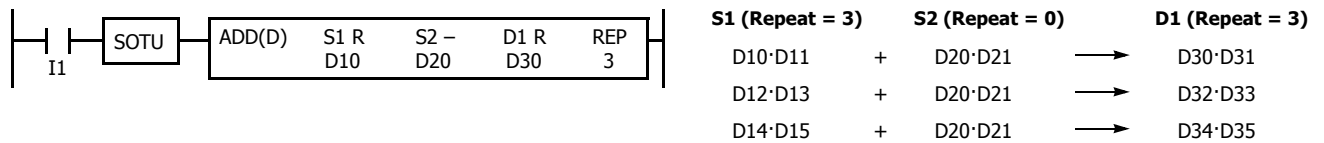

Repeat All Source and Destination Devices

- **Data Type: Word and Integer**

When all devices are assigned to repeat, different results are set to 3 devices starting with D1.

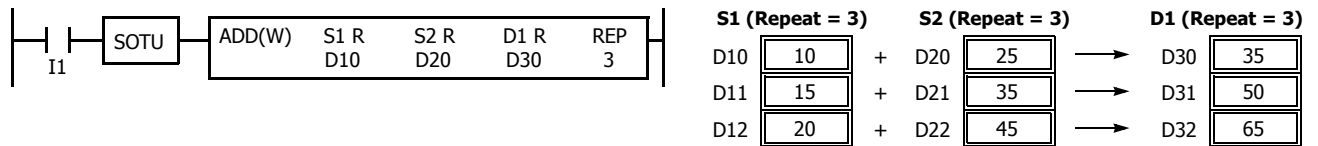

- **Data Type: Double Word, Long, and Float**

When all devices are assigned to repeat, different results are set to 3 devices starting with D1·D1+1.

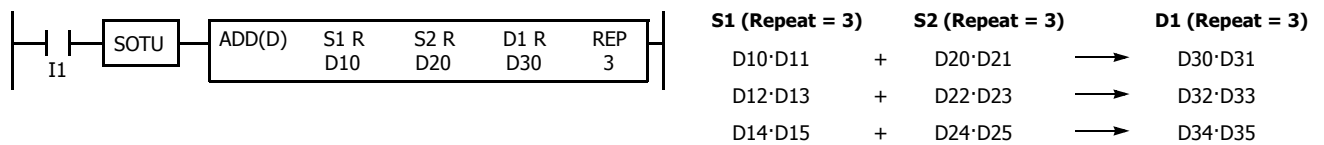

Note: Special internal relay M8003 (carry/borrow) is turned on when a carry or borrow occurs in the last repeat operation. When a user program execution error occurs in any repeat operation, special internal relay M8004 (user program execution error) and the ERR LED are turned on and maintained while operations for other instructions continues.

Repeat Operation in the MUL Instruction

Since the MUL (multiplication) instruction uses two destination devices, the result is stored to destination devices as described below. Source devices S1 and S2 and destination device D1 can be designated to repeat individually or in combination. When destination device D1 is not assigned to repeat, the final result is set to destination device D1 and D1+1. When repeat is designated, consecutive devices as many as the repeat cycles starting with the designated device are used.

Since the repeat operation works similarly on word and integer data, the following examples are described using word data.

Repeat One Source Device

When only S1 (source) is assigned to repeat, the final result is set to destination device D1·D1+1.

- **Data Type: Word and Integer**

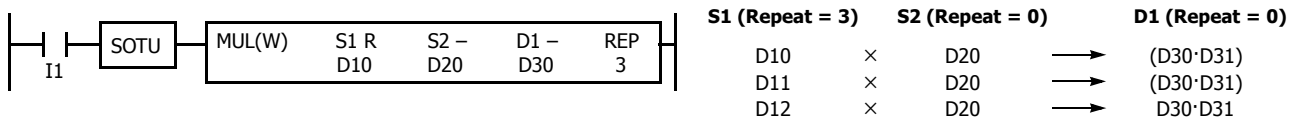

- **Data Type: Double Word, Long, and Float**

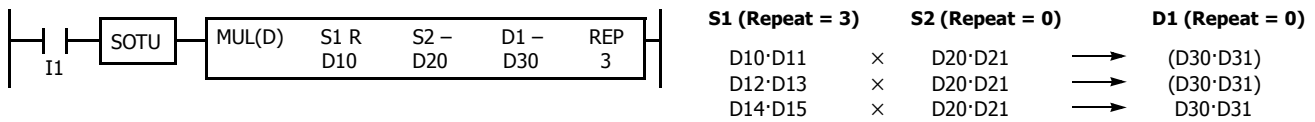

Repeat Destination Device Only

When only D1 (destination) is assigned to repeat, the same result is set to 3 devices starting with D1·D1+1.

- **Data Type: Word and Integer**

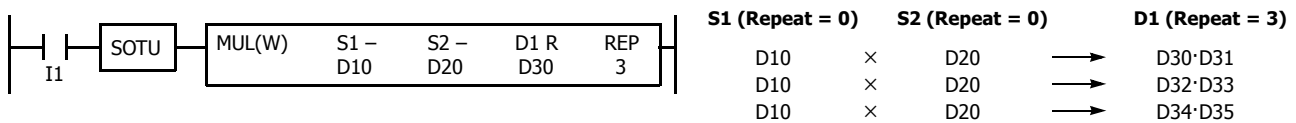

- **Data Type: Double Word, Long, and Float**

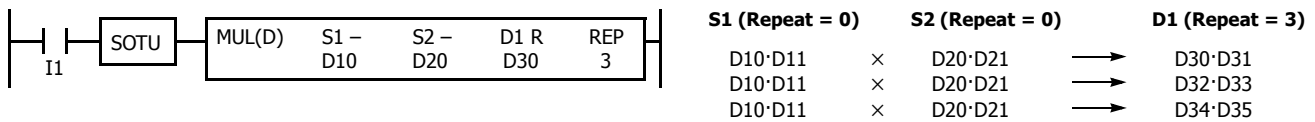

Repeat Two Source Devices

When S1 and S2 (source) are assigned to repeat, the final result is set to destination device D1·D1+1.

- **Data Type: Word and Integer**

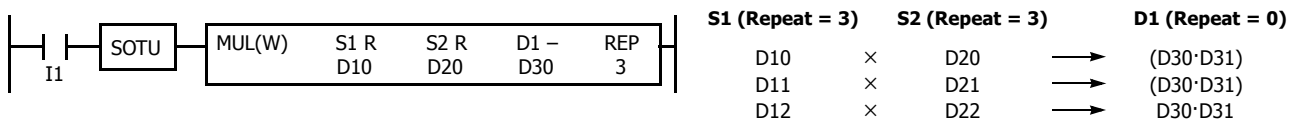

- **Data Type: Double Word, Long, and Float**

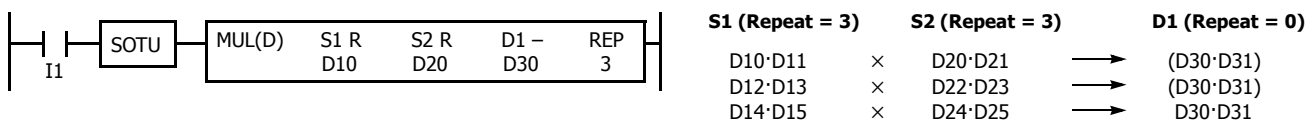

Repeat Source and Destination Devices

When S1 (source) and D1 (destination) are assigned to repeat, different results are set to 3 devices starting with D1·D1+1.

- **Data Type: Word and Integer**

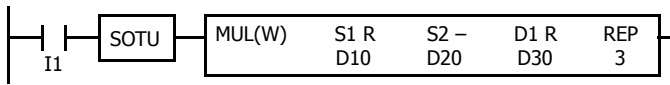

| S1 (Repeat = 3) | S2 (Repeat = 0) | D1 (Repeat = 3) |
|-----------------|-----------------|-----------------|
| D10 | × D20 | → D30·D31 |
| D11 | × D20 | → D32·D33 |
| D12 | × D20 | → D34·D35 |

- **Data Type: Double Word, Long, and Float**

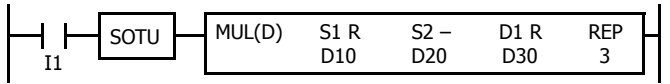

| S1 (Repeat = 3) | S2 (Repeat = 0) | D1 (Repeat = 3) |
|-----------------|-----------------|-----------------|
| D10·D11 | × D20·D21 | → D30·D31 |
| D12·D13 | × D20·D21 | → D32·D33 |
| D14·D15 | × D20·D21 | → D34·D35 |

Repeat All Source and Destination Devices

When all devices are assigned to repeat, different results are set to 3 devices starting with D1·D1+1.

- **Data Type: Word and Integer**

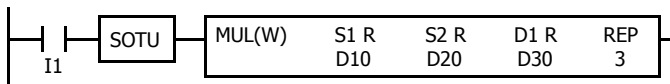

| S1 (Repeat = 3) | S2 (Repeat = 3) | D1 (Repeat = 3) |
|-----------------|-----------------|-----------------|
| D10 | × D20 | → D30·D31 |
| D11 | × D21 | → D32·D33 |
| D12 | × D22 | → D34·D35 |

- **Data Type: Double Word, Long, and Float**

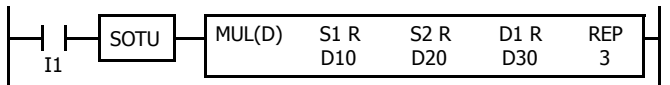

| S1 (Repeat = 3) | S2 (Repeat = 3) | D1 (Repeat = 3) |
|-----------------|-----------------|-----------------|
| D10·D11 | × D20·D21 | → D30·D31 |
| D12·D13 | × D22·D23 | → D32·D33 |
| D14·D15 | × D24·D25 | → D34·D35 |

Repeat Operation in the DIV Instruction

Since the DIV (division) instruction (except float data) uses two destination devices, the quotient and remainder are stored as described below. Source devices S1 and S2 and destination device D1 can be assigned to repeat individually or in combination. When destination device D1 is not assigned to repeat, the final result is set to destination device D1 (quotient) and D1+1 (remainder). When repeat is assigned, assigned as many consecutive devices as the repeat cycles starting with the designated device are used.

Division instructions in float data do not generate remainders and use two consecutive data registers to store quotients. When repeat is assigned for destination of float data, as many consecutive data registers as the repeat cycles are used.

Repeat One Source Device

• **Data Type: Word and Integer**

When only S1 (source) is assigned to repeat, the final result is set to destination devices D1 and D1+1.

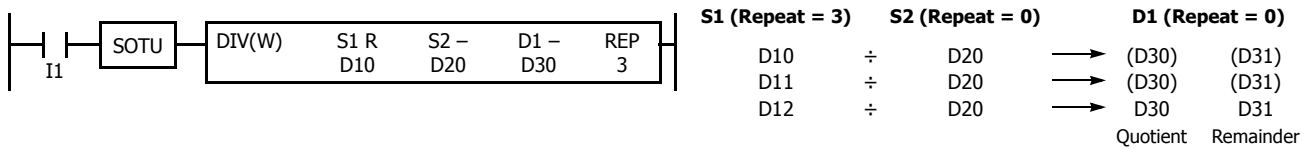

• **Data Type: Double Word and Long**

When only S1 (source) is assigned to repeat, the final result is set to destination devices D1·D1+1 and D1+2·D1+3.

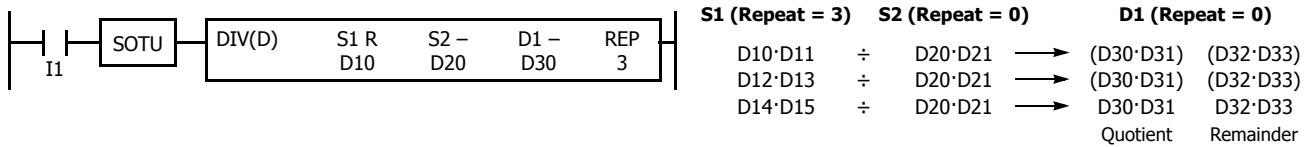

• **Data Type: Float**

When only S1 (source) is assigned to repeat, the final result is set to destination devices D1·D1+1.

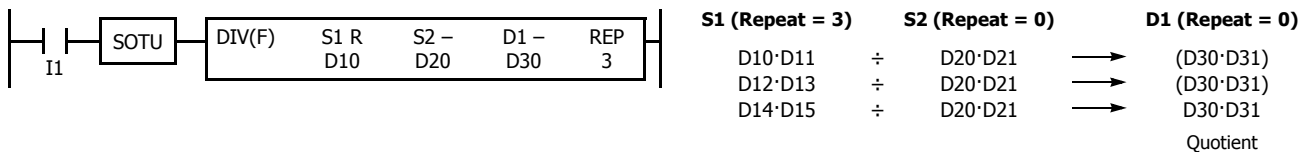

Repeat Destination Device Only

• **Data Type: Word and Integer**

When only D1 (destination) is assigned to repeat, the same result is set to 6 devices starting with D1.

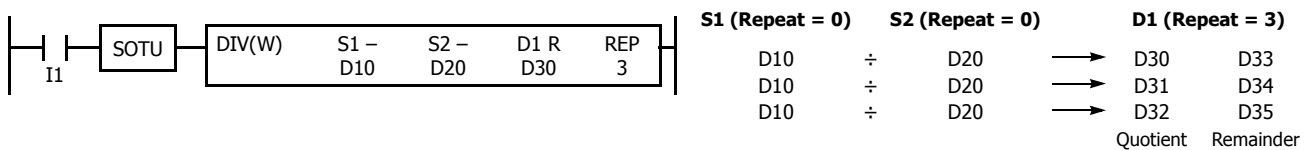

• **Data Type: Double Word and Long**

When only D1 (destination) is assigned to repeat, the same result is set to 6 devices starting with D1·D1+1.

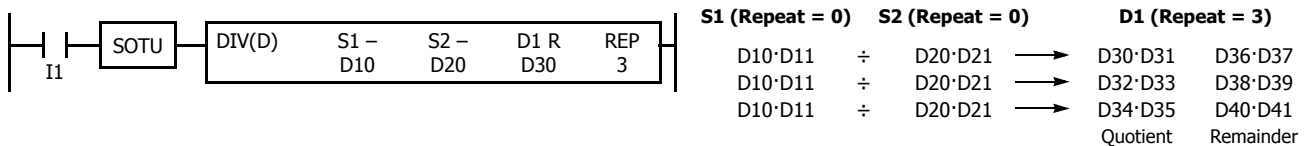

• **Data Type: Float**

When only D1 (destination) is assigned to repeat, the same result is set to 3 devices starting with D1·D1+1.

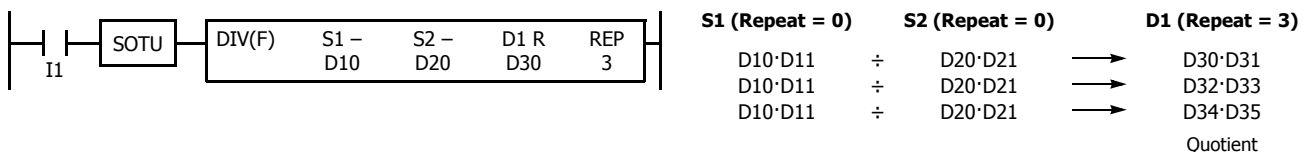

Repeat Two Source Devices

• **Data Type: Word and Integer**

When S1 and S2 (source) are assigned to repeat, the final result is set to destination devices D1 and D1+1.

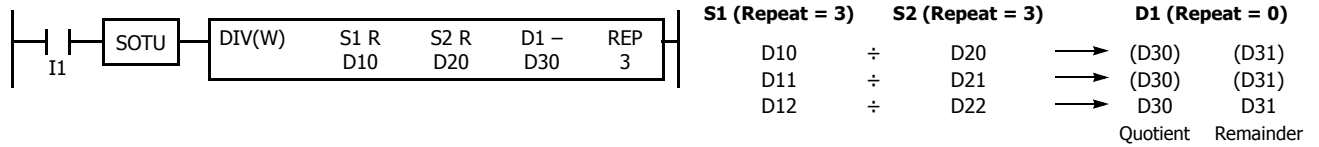

• **Data Type: Double Word and Long**

When S1 and S2 (source) are assigned to repeat, the final result is set to destination devices D1·D1+1 and D1+2·D1+3.

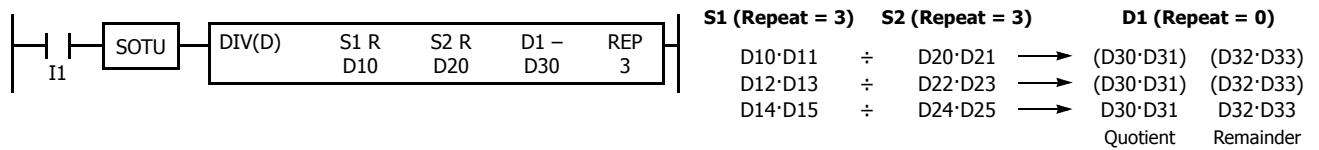

• **Data Type: Float**

When S1 and S2 (source) are assigned to repeat, the final result is set to destination devices D1·D1+1.

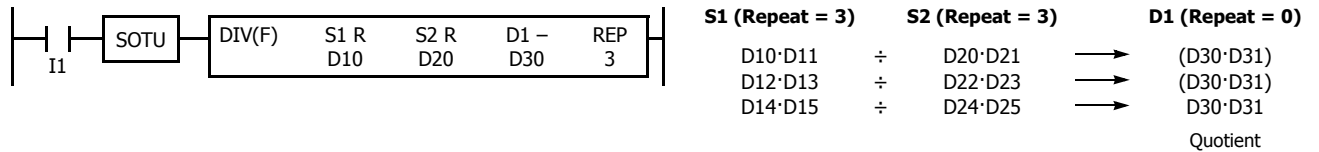

Repeat Source and Destination Devices

• **Data Type: Word and Integer**

When S1 (source) and D1 (destination) are assigned to repeat, different results are set to 6 devices starting with D1.

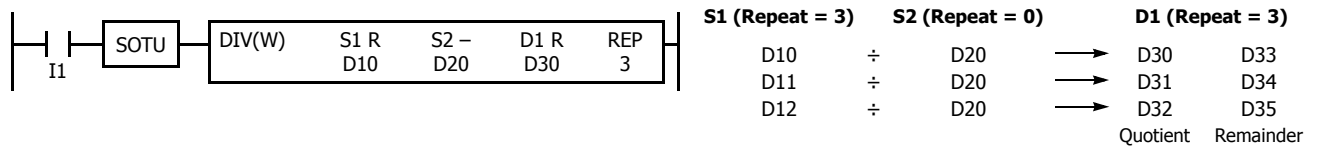

• **Data Type: Double Word and Long**

When S1 (source) and D1 (destination) are assigned to repeat, different results are set to 6 devices starting with D1·D1+1.

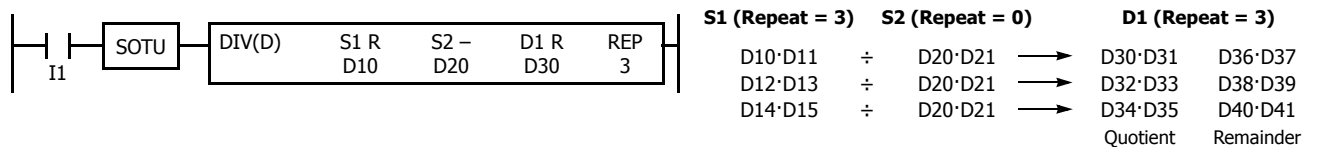

• **Data Type: Float**

When S1 (source) and D1 (destination) are assigned to repeat, different results are set to 3 devices starting with D1·D1+1.

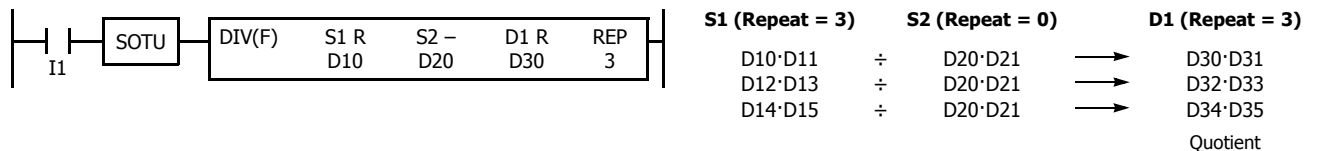

8: BINARY ARITHMETIC INSTRUCTIONS

Repeat All Source and Destination Devices

- **Data Type: Word and Integer**

When all devices are assigned to repeat, different results are set to 6 devices starting with D1.

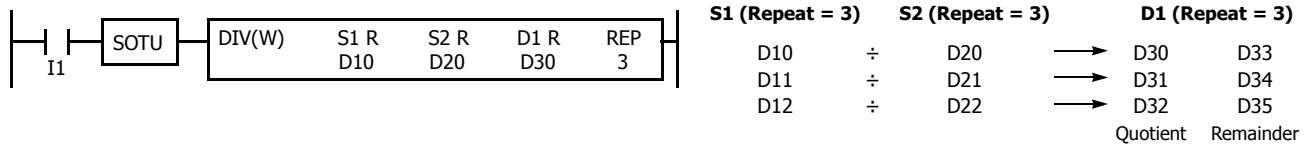

- **Data Type: Double Word and Long**

When all devices are assigned to repeat, different results are set to 6 devices starting with D1·D1+1.

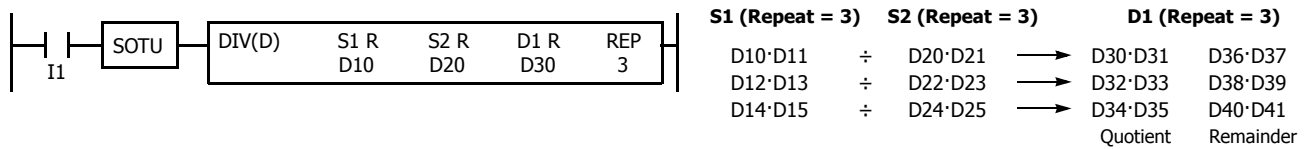

- **Data Type: Float**

When all devices are assigned to repeat, different results are set to 3 devices starting with D1·D1+1.

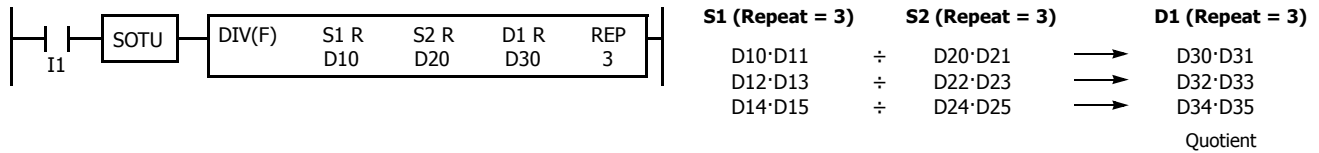

Note: When a user program execution error occurs in any repeat operation, special internal relay M8004 (user program execution error) and the ERR LED are turned on and maintained while operations for other instructions continues.

INC (Increment)

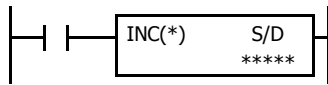

Data type W or I: $S/D + 1 \rightarrow S/D$
 Data type D or L: $S/D \cdot S/D+1 + 1 \rightarrow S/D \cdot S/D+1$

When input is on, one is added to the 16- or 32-bit data assigned by device S/D and the result is stored to the same device.

DEC (Decrement)

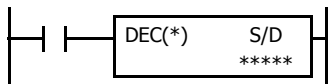

Data type W or I: $S/D - 1 \rightarrow S/D$
 Data type D or L: $S/D \cdot S/D+1 - 1 \rightarrow S/D \cdot S/D+1$

When input is on, one is subtracted from the 16- or 32-bit data assigned by device S/D and the result is stored to the same device.

Applicable SmartAXIS

| FT1A-12 | FT1A-24 | FT1A-40 | FT1A-48 | FT1A-Touch |
|---------|---------|---------|---------|------------|
| X | X | X | X | X |

Valid Devices

| Device | Function | I | Q | M | R | T | C | D | Constant | Repeat |
|--------------------------|--------------------------|---|---|---|---|---|---|---|----------|--------|
| S/D (Source/Destination) | Device to increment data | — | — | — | — | — | — | X | — | — |

For valid device address ranges, see "Device Addresses" on page 3-1.

Since the INC and DEC instructions are executed in each scan while input is on, a pulse input from a SOTU or SOTD instruction should be used.

Valid Data Types

| | |
|------------------------|---|
| W (word) | X |
| I (integer) | X |
| D (double word) | X |
| L (long) | X |
| F (float) | — |

When a word device such as D (data register) is assigned as the source/destination, 1 point (word or integer data) or 2 points (double-word or long data) are used.

Increment beyond Limits

When the S/D value is at its maximum and is incremented by one, the value returns to 0, turning on the carry (M8003).

Decrement beyond Limits

When the S/D value is at its minimum and is decremented by one, the value returns to its maximum value (word or double-word data) or to -1 (integer or long data), turning on the internal relay M8003 (carry or borrow).

Example: INC

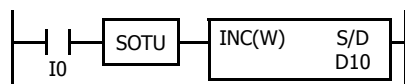

$$D10 \boxed{100} + 1 \rightarrow D10 \boxed{101}$$

When input I0 is turned on, the data of D10 is incremented by one.
 If SOTU is not programmed, the data of D10 is incremented in each scan.

Example: DEC

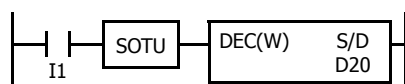

$$D20 \boxed{100} - 1 \rightarrow D20 \boxed{99}$$

When input I1 is turned on, the data of D20 is decremented by one.
 If SOTU is not programmed, the data of D20 is decremented in each scan.

ROOT (Root)

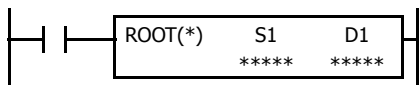

Data type W:

$$\sqrt{S1} \rightarrow D1$$

When input is on, the square root of the device assigned by S1 is extracted and stored to the destination assigned by D1.

The square root is calculated to two decimals, omitting the figures below the second place of decimals, and multiplied by 100.

Data type D:

$$\sqrt{S1 \cdot S1 + 1} \rightarrow D1 \cdot D1 + 1$$

When input is on, the square root of the device assigned by S1·S1+1 is extracted and is stored to the destination assigned by D1·D1+1.

The square root is calculated to two decimals, omitting the figures below the second place of decimals, and multiplied by 100.

Data type F:

$$\sqrt{S1 \cdot S1 + 1} \rightarrow D1 \cdot D1 + 1$$

When input is on, the square root of the device assigned by S1·S1+1 is extracted and is stored to the destination assigned by D1·D1+1.

Applicable SmartAXIS

| FT1A-12 | FT1A-24 | FT1A-40 | FT1A-48 | FT1A-Touch |
|---------|---------|---------|---------|------------|
| X | X | X | X | X |

Valid Devices

| Device | Function | I | Q | M | R | T | C | D | Constant | Repeat |
|--------------------|------------------------------|---|---|---|---|---|---|---|----------|--------|
| S1 (Source 1) | Binary data | — | — | — | — | — | — | X | X | — |
| D1 (Destination 1) | Destination to store results | — | — | — | — | — | — | X | — | — |

For valid device address ranges, see "Device Addresses" on page 3-1.

When F (float) data is selected and source device S1 contains a negative value, a user program execution error will result, turning on special internal relay M8004 and the ERR LED on the SmartAXIS.

When F (float) data is selected and S1 does not comply with the normal floating-point format, a user program execution error will result, turning on special internal relay M8004 and ERR LED on the SmartAXIS.

When a user program execution error occurs, the execution of the instruction is canceled. The value of D1 is left unchanged and the next instruction is executed. For user program execution errors, see "User Program Execution Errors" on page 4-13.

Since the ROOT instruction is executed in each scan while input is on, a pulse input from a SOTU or SOTD instruction should be used.

Valid Data Types

| | |
|-----------------|---|
| W (word) | X |
| I (integer) | — |
| D (double word) | X |
| L (long) | — |
| F (float) | X |

When a word device such as D (data register) is assigned as the source or destination, 1 point (word data) or 2 points (double-word or float data) are used.

Examples: ROOT

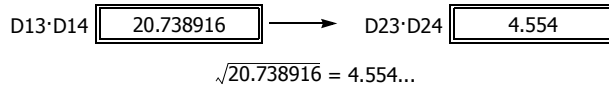
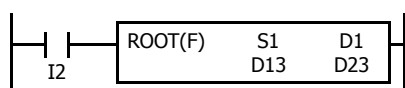
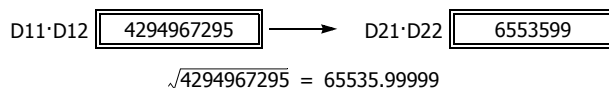
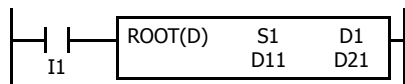
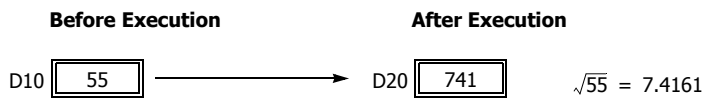
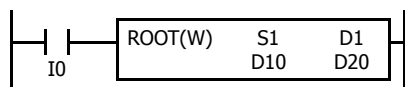

SUM (Sum)

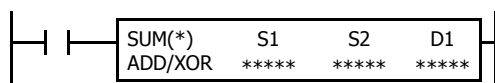

Calculates the total of assigned data, depending on the calculation option.

ADD:

When input is on, N blocks of 16- or 32-bit data starting at device assigned by S1 are added together and the result is stored to the device assigned by D1. S2 specifies the quantity of data blocks.

XOR:

When input is on, N blocks of 16-bit data starting at the device assigned by S1 are XORed and the result is stored to the device assigned by D1. S2 specifies the quantity of data blocks.

Applicable SmartAXIS

| FT1A-12 | FT1A-24 | FT1A-40 | FT1A-48 | FT1A-Touch |
|---------|---------|---------|---------|------------|
| X | X | X | X | X |

Valid Devices

| Device | Function | I | Q | M | R | T | C | D | Constant | Repeat |
|--------------------|-----------------------------------|---|---|---|---|---|---|---|----------|--------|
| S1 (Source 1) | First device address to calculate | — | — | — | — | X | X | X | — | — |
| S2 (Source 2) | Quantity of data blocks | — | — | — | — | — | — | X | X | — |
| D1 (Destination 1) | Destination to store results | — | — | — | — | — | — | X | — | — |

For valid device address ranges, see "Device Addresses" on page 3-1.

When T (timer) or C (counter) is used as S1, the timer/counter current value (TC or CC) is displayed.

When F (float) data is selected, only a data register can be designated as S1.

For source S2, 1 word is always used without regard to the data type.

When F (float) data is selected and S1 does not comply with the normal floating-point format, a user program execution error will result, turning on special internal relay M8004 and ERR LED on the SmartAXIS.

When S2 is 0 or exceeds the correct value range for the selected device, a user program execution error will result, turning on special internal relay M8004 and ERR LED on the SmartAXIS. For user program execution errors, see "User Program Execution Errors" on page 4-13.

Valid Data Types

| Calculation | ADD | XOR |
|-----------------|-----|-----|
| W (word) | X | X |
| I (integer) | X | — |
| D (double word) | X | — |
| L (long) | X | — |
| F (float) | X | — |

When ADD is selected, all data types can be used.

When XOR is selected, only W (word) data can be used.

When a word device such as T (timer), C (counter), or D (data register) is assigned as the source or destination, 1 point (word or integer data) or 2 points (double-word, long, or float data) are used.

Quantity of Source and Destination Devices

Depending on the ADD or XOR operation for W (word) and I (integer) data, the destination uses a different quantity of devices.

| Operation | W (word), I (integer) | D (double word), L (long), F (float) |
|-----------|---|---|
| ADD | S1, S2: 1 word device D1: 2 word devices | S1, D1: 2 word devices S2: 1 word device |
| XOR | S1, S2, D1: 1 word device | — |

8: BINARY ARITHMETIC INSTRUCTIONS

Carry and Borrow

In advanced instructions involving D (double word), L (long), or F (floating point) data, special internal relay M8003 (carry and borrow) is turned on when the execution of the instruction results in the following value.

| Data Type | M8003 | Execution Result |
|-----------------|-------|---|
| D (double word) | 1 | Exceeds the range between 0 to 4,294,967,295 |
| L (long) | 1 | Exceeds the range between -2,147,483,648 to 2,147,483,647 |
| F (float) | 1 | See the figure below. |

Carry and Borrow in Floating-Point Data Processing

When advanced instructions involving floating-point data are executed, special internal relay M8003 (carry and borrow) is updated.

| M8003 | Execution Result | Value |
|-------|------------------|---|
| 1 | ≠ 0 | Overflow (exceeds the range between -3.402823×10^{38} and 3.402823×10^{38}) |
| 1 | 0 | Not zero (within the range between $-1.175495 \times 10^{-38}$ and 1.175495×10^{-38}) |
| 0 | 0 | Zero |

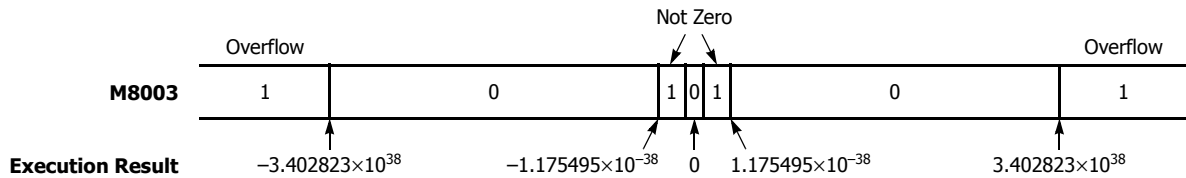

Examples: SUM

- Data Type: Word

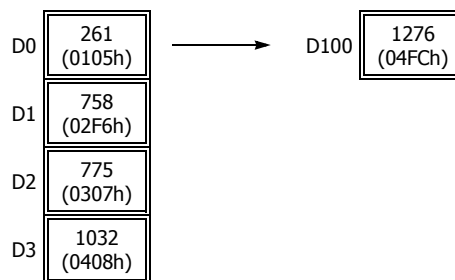
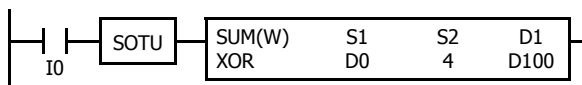
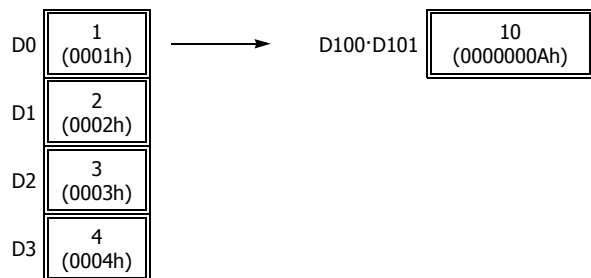
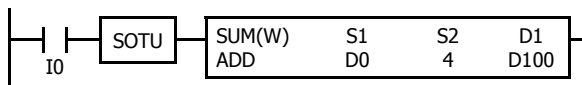

XOR Operation

| | | | |
|-----|------|---------|---------------------|
| | D0 | (0105h) | 0000 0001 0000 0101 |
| | D1 | (02F6h) | 0000 0010 1111 0110 |
| | D2 | (0307h) | 0000 0011 0000 0111 |
| XOR | D3 | (0408h) | 0000 0100 0000 1000 |
| | D100 | (04FCh) | 0000 0100 1111 1100 |

• Data Type: Integer

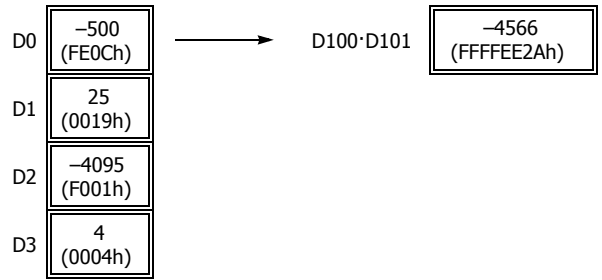
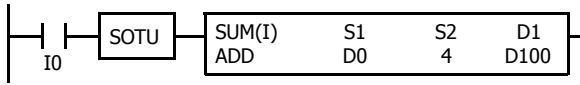

• Data Type: Double Word

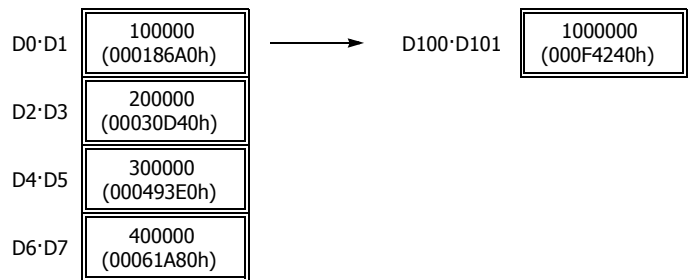
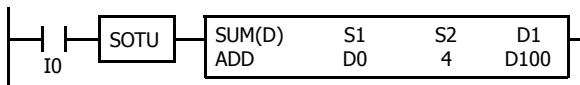

• Data Type: Long

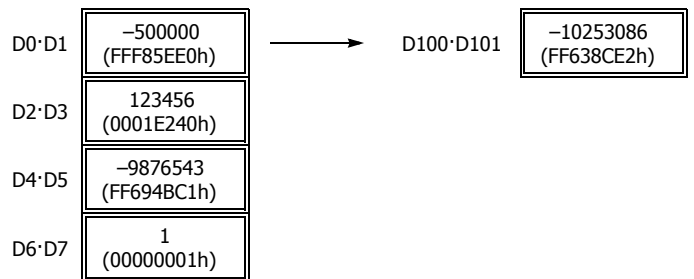
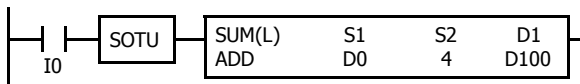

• Data Type: Float

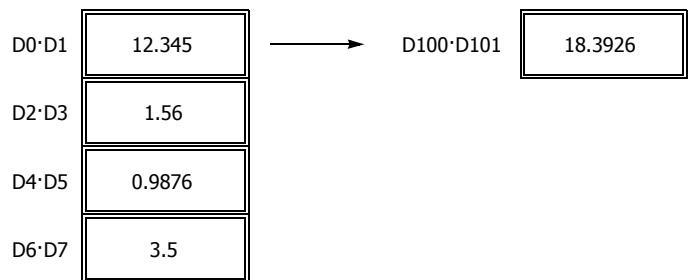
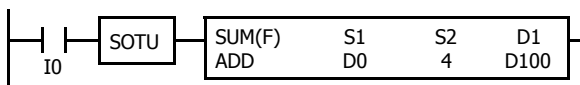

9: BOOLEAN COMPUTATION INSTRUCTIONS

Introduction

Boolean computations use the AND, OR, and exclusive OR statements as carried out by the ANDW, ORW, and XORW instructions in the word or double-word data, respectively.

ANDW (AND Word)

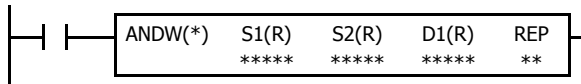

$$S1 \cdot S2 \rightarrow D1$$

When input is on, 16- or 32-bit data assigned by source devices S1 and S2 are ANDed, bit by bit. The result is set to destination device D1.

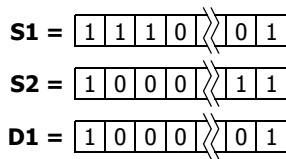

| S1 | S2 | D1 |
|----|----|----|
| 0 | 0 | 0 |
| 0 | 1 | 0 |
| 1 | 0 | 0 |
| 1 | 1 | 1 |

ORW (OR Word)

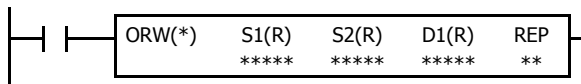

$$S1 + S2 \rightarrow D1$$

When input is on, 16- or 32-bit data assigned by source devices S1 and S2 are ORed, bit by bit. The result is set to destination device D1.

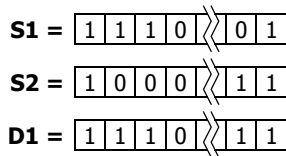

| S1 | S2 | D1 |
|----|----|----|
| 0 | 0 | 0 |
| 0 | 1 | 1 |
| 1 | 0 | 1 |
| 1 | 1 | 1 |

XORW (Exclusive OR Word)

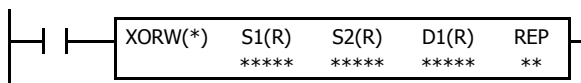

$$S1 \oplus S2 \rightarrow D1$$

When input is on, 16- or 32-bit data assigned by source devices S1 and S2 are exclusive ORed, bit by bit. The result is set to destination device D1.

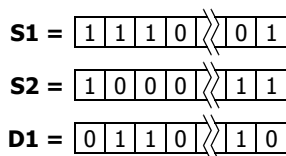

| S1 | S2 | D1 |
|----|----|----|
| 0 | 0 | 0 |
| 0 | 1 | 1 |
| 1 | 0 | 1 |
| 1 | 1 | 1 |

Applicable SmartAXIS

| FT1A-12 | FT1A-24 | FT1A-40 | FT1A-48 | FT1A-Touch |
|---------|---------|---------|---------|------------|
| X | X | X | X | X |

9: BOOLEAN COMPUTATION INSTRUCTIONS

Valid Devices

| Device | Function | I | Q | M | R | T | C | D | Constant | Repeat |
|--------------------|------------------------------|---|---|---|---|---|---|---|----------|--------|
| S1 (Source 1) | Data for computation | X | X | X | X | X | X | X | X | 1-99 |
| S2 (Source 2) | Data for computation | X | X | X | X | X | X | X | X | 1-99 |
| D1 (Destination 1) | Destination to store results | — | X | ▲ | X | X | X | X | — | 1-99 |

For valid device address ranges, see "Device Addresses" on page 3-1.

▲ Internal relays M0 through M1277 can be assigned as D1. Special internal relays cannot be assigned as D1.

When T (timer) or C (counter) is used as S1 or S2, the timer/counter current value (TC or CC) is displayed. When T (timer) or C (counter) is used as D1, the data is written in as a preset value (TP or CP) which can be 0 through 65535.

Since the Boolean computation instructions are executed in each scan while input is on, a pulse input from a SOTU or SOTD instruction should be used.

Valid Data Types

| | | |
|------------------------|---|---|
| W (word) | X | When a bit device such as I (input), Q (output), M (internal relay), or R (shift register) is assigned as the source or destination, 16 points (word data) or 32 points (double-word data) are used. When repeat is assigned for a bit device, the quantity of device bits increases in 16- or 32-point increments. |
| I (integer) | — | |
| D (double word) | X | |
| L (long) | — | When a word device such as T (timer), C (counter), or D (data register) is assigned as the source or destination, 1 point (word data) or 2 points (double-word data) are used. When repeat is assigned for a word device, the quantity of device words increases in 1- or 2-point increments. |
| F (float) | — | |

Example: XORW

To convert optional output status among a series of 10 output points, use the XORW instruction in combination with 10 internal relay points.

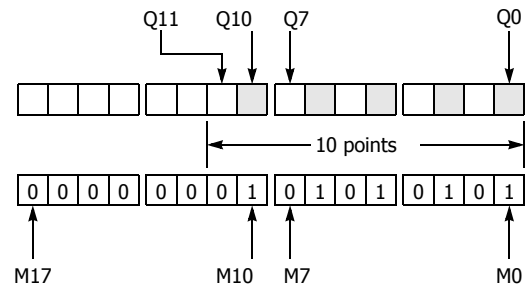

This program will invert the status of the shaded outputs on the left from on to off, and those not shaded from off to on.

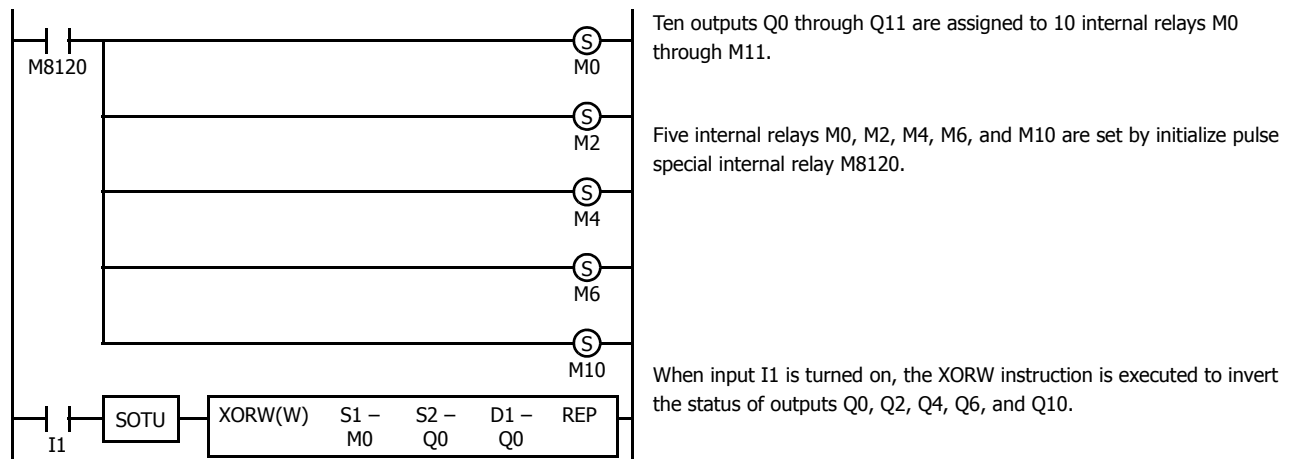

Repeat Operation in the ANDW, ORW, and XORW Instructions

Source devices S1 and S2 and destination device D1 can be assigned to repeat individually or in combination. When destination device D1 is not designated set to repeat, the final result is set to destination device D1. When repeat is assigned, consecutive devices as many as the repeat cycles starting with the designated device are used. Since the repeat operation works similarly on the ANDW (AND word), ORW (OR word), and XORW (exclusive OR word) instructions, the following examples use the ANDW instruction.

Repeat One Source Device

- **Data Type: Word**

When only S1 (source) is assigned to repeat, the final result is set to destination device D1.

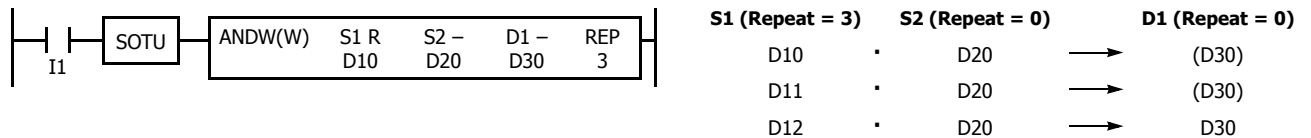

- **Data Type: Double Word**

When only S1 (source) is assigned to repeat, the final result is set to destination device D1·D1+1.

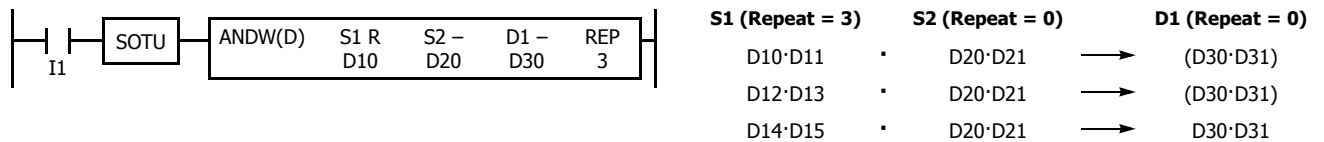

Repeat Destination Device Only

- **Data Type: Word**

When only D1 (destination) is assigned to repeat, the same result is set to 3 devices starting with D1.

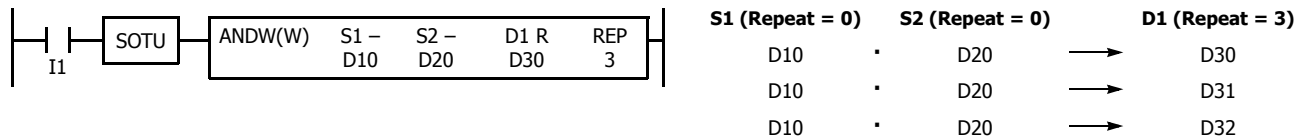

- **Data Type: Double Word**

When only D1 (destination) is assigned to repeat, the same result is set to 3 devices starting with D1·D1+1.

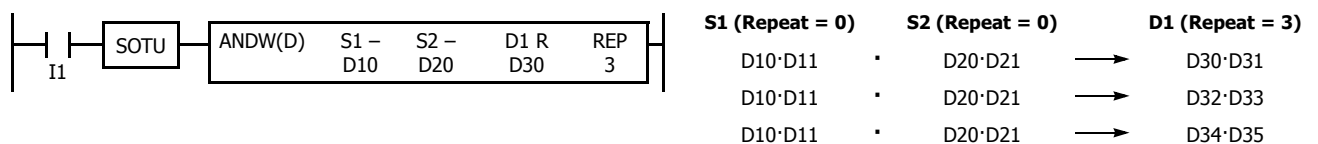

Repeat Two Source Devices

- **Data Type: Word**

When S1 and S2 (source) are assigned to repeat, the final result is set to destination device D1.

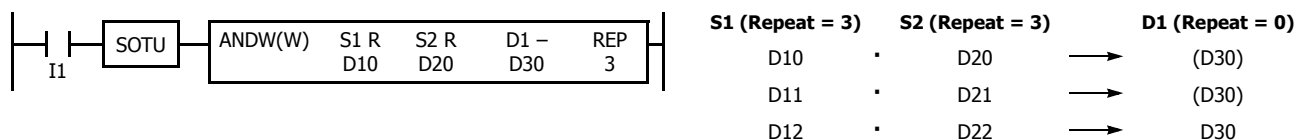

- **Data Type: Double Word**

When S1 and S2 (source) are assigned to repeat, the final result is set to destination device D1·D1+1.

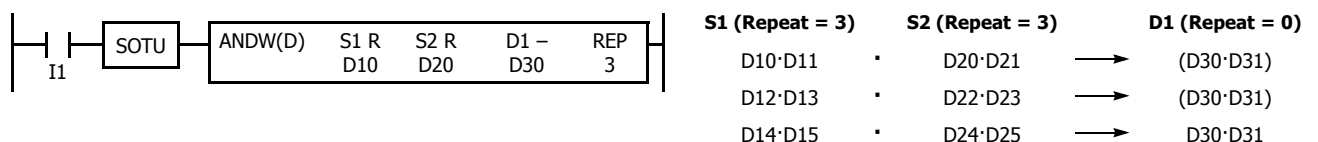

9: BOOLEAN COMPUTATION INSTRUCTIONS

Repeat Source and Destination Devices

• Data Type: Word

When S1 (source) and D1 (destination) are assigned to repeat, different results are set to 3 devices starting with D1.

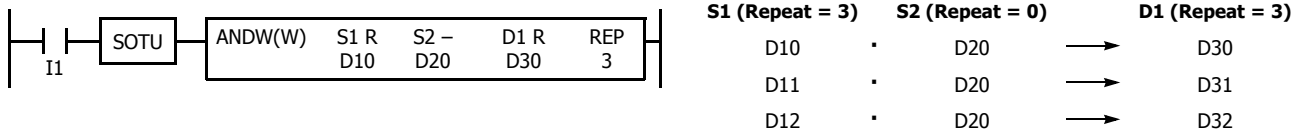

• Data Type: Double Word

When S1 (source) and D1 (destination) are assigned to repeat, different results are set to 3 devices starting with D1·D1+1.

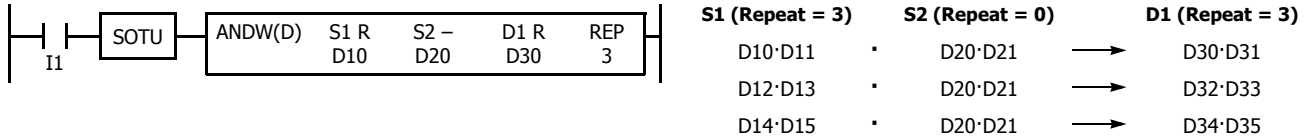

Repeat All Source and Destination Devices

• Data Type: Word

When all devices are assigned to repeat, different results are set to 3 devices starting with D1.

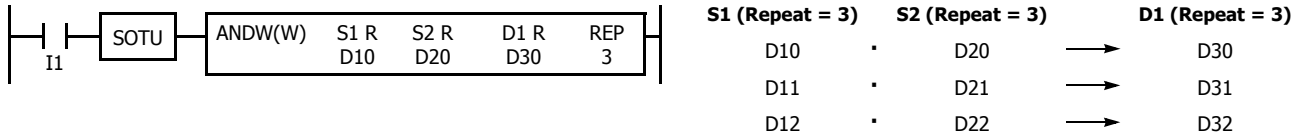

• Data Type: Double Word

When all devices are assigned to repeat, different results are set to 3 devices starting with D1·D1+1.

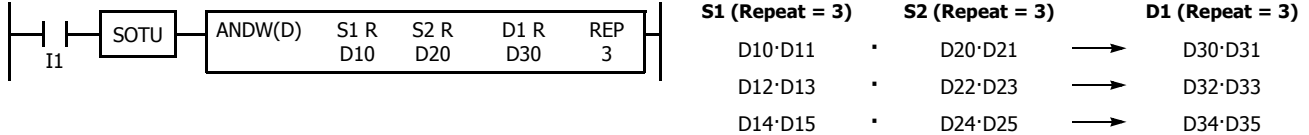

Note: When a user program error occurs in any repeat operation, special internal relay M8004 (user program execution error) and the ERROR LED are turned on and maintained while operations for other instructions continues. For an advanced instruction that has caused a user program execution error due to an error in the source devices, results are not set to any destination.

10: SHIFT / ROTATE INSTRUCTIONS

Introduction

Bit shift instructions are used to shift the data string starting with source device S1 to the left or right by 1 to 15 bits as designated. The data string can be 1 to 65535 bits. The result is set to the source device S1 and special internal relay M8003 (carry or borrow). The LSB or MSB is filled with 0 or 1 as designated.

Bit shift and rotate instructions are used to shift the 16- or 32-bit data string in the designated source device S1 to the left or right by the quantity of bits designated. The result is set to the source device S1 and special internal relay M8003 (carry or borrow).

The BCD left shift instruction shifts the BCD digits in two consecutive data registers to the left.

The word shift instruction is used to move 16-bit data to a destination data register and shifts down the data of subsequent data registers as many as designated.

SFTL (Shift Left)

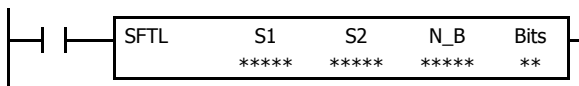

CY ← S1

When input is on, N_B-bit data string starting with source device S1 is shifted to the left by the quantity of bits assigned by device Bits.

The result is set to source device S1, and the last bit status shifted out is set to special internal relay M8003 (carry or borrow). Zero or 1 assigned by source device S2 is set to the LSB.

- S2 = 0, N_B = 16, Bits = 1

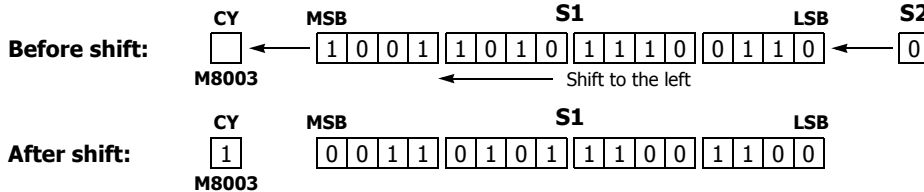

Applicable SmartAXIS

| FT1A-12 | FT1A-24 | FT1A-40 | FT1A-48 | FT1A-Touch |
|---------|---------|---------|---------|------------|
| X | X | X | X | X |

Valid Devices

| Device | Function | I | Q | M | R | T | C | D | Constant | Repeat |
|---------------|-----------------------------------|---|---|---|---|---|---|---|----------|--------|
| S1 (Source 1) | First data for bit shift | — | X | ▲ | X | — | — | X | — | — |
| S2 (Source 2) | Data to shift into the LSB | X | X | X | X | — | — | — | 0 or 1 | — |
| N_B | Number of bits in the data string | — | — | — | — | — | — | X | 1-65535 | — |
| Bits | Quantity of bits to shift | — | — | — | — | — | — | X | 1-15 | — |

For valid device address ranges, see Chapter 5 "Special Functions" - "Device Addresses" in the SmartAXIS Touch User's Manual.

▲ Internal relays M0 through M1277 can be designated as S1. Special internal relays cannot be designated as S1.

Since the SFTL instruction is executed in each scan while input is on, a pulse input from a SOTU or SOTD instruction should be used.

10: SHIFT / ROTATE INSTRUCTIONS

Examples: SFTL

- **N_B = 16 bits**

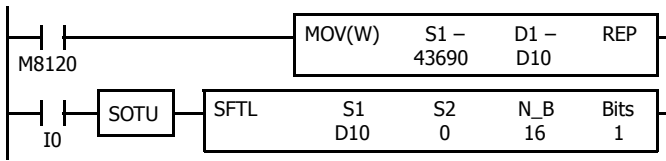

M8120 is the initialize pulse special internal relay.

When the CPU starts operation, the MOV (move) instruction sets 43690 to data register D10.

Each time input I0 is turned on, 16-bit data of data register D10 is shifted to the left by 1 bit as assigned by device Bits. The last bit status shifted out is set to special internal relay M8003 (carry or borrow). Zeros are set to the LSB.

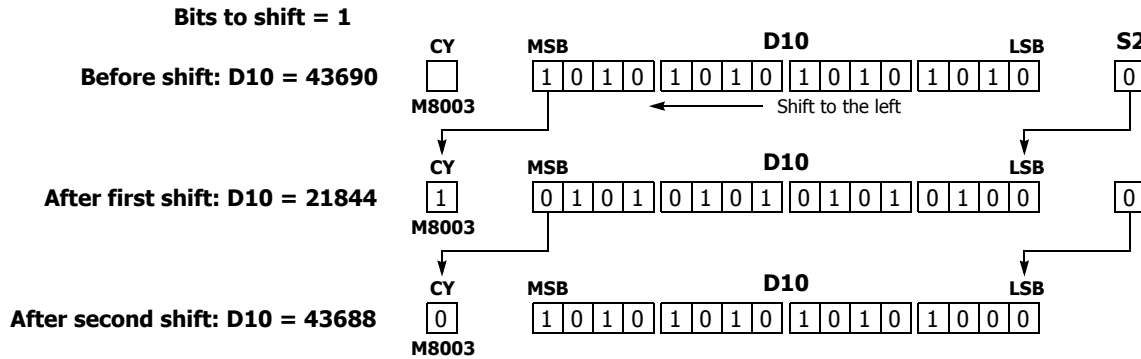

- **N_B = 32 bits**

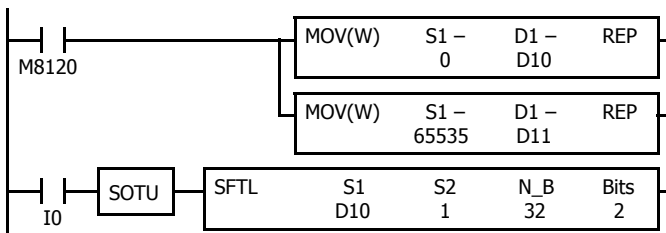

M8120 is the initialize pulse special internal relay.

When the CPU starts operation, the MOV (move) instructions set 0 and 65535 to data registers D10 and D11, respectively.

Each time input I0 is turned on, 32-bit data of data registers D10 and D11 is shifted to the left by 2 bits as assigned by device Bits. D10 is the low word, and D11 is the high word.

The last bit status shifted out is set to a carry (special internal relay M8003). Ones are set to the LSBs.

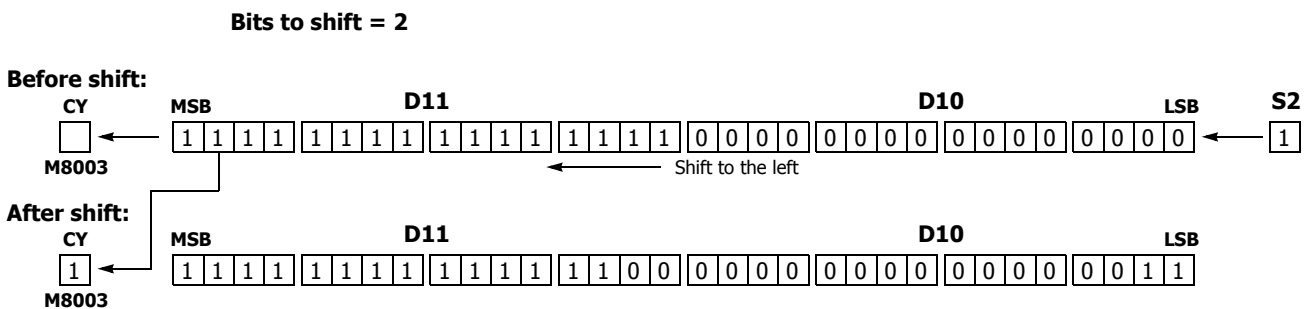

SFTR (Shift Right)

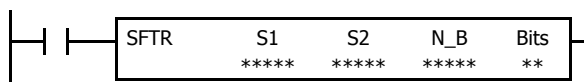

S1 → CY

When input is on, N_B-bit data string starting with source device S1 is shifted to the right by the quantity of bits assigned by device Bits.

The result is set to source device S1, and the last bit status shifted out is set to a carry (special internal relay M8003). Zero or 1 assigned by source device S2 is set to the MSB.

- S2 = 0, N_B = 16, Bits = 1

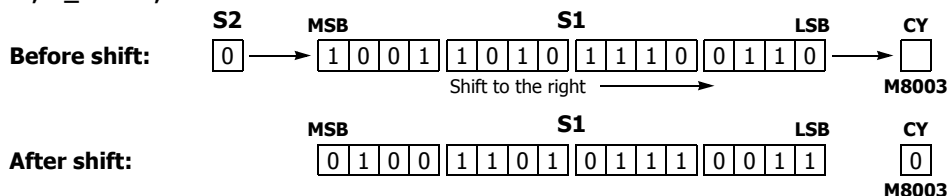

Applicable SmartAXIS

| FT1A-12 | FT1A-24 | FT1A-40 | FT1A-48 | FT1A-Touch |
|---------|---------|---------|---------|------------|
| X | X | X | X | X |

Valid Devices

| Device | Function | I | Q | M | R | T | C | D | Constant | Repeat |
|---------------|-----------------------------------|---|---|---|---|---|---|---|----------|--------|
| S1 (Source 1) | First data for bit shift | — | X | ▲ | X | — | — | X | — | — |
| S2 (Source 2) | Data to shift into the MSB | X | X | X | X | — | — | — | 0 or 1 | — |
| N_B | Number of bits in the data string | — | — | — | — | — | — | X | 1-65535 | — |
| Bits | Quantity of bits to shift | — | — | — | — | — | — | X | 1-15 | — |

For valid device address ranges, see Chapter 5 "Special Functions" - "Device Addresses" in the SmartAXIS Touch User's Manual.

Since the SFTR instruction is executed in each scan while input is on, a pulse input from a SOTU or SOTD instruction should be used.

BCDLS (BCD Left Shift)



When input is on, the 32-bit binary data assigned by S1 is converted into 8 BCD digits, shifted to the left by the quantity of digits assigned by S2, and converted back to 32-bit binary data.

Valid values for each of S1 and S1+1 are 0 through 9999.

The number of digits that can be shifted is 1 through 7.

Zero is set to the lowest digit after each shift.

When S2 = 1 (digits to shift)

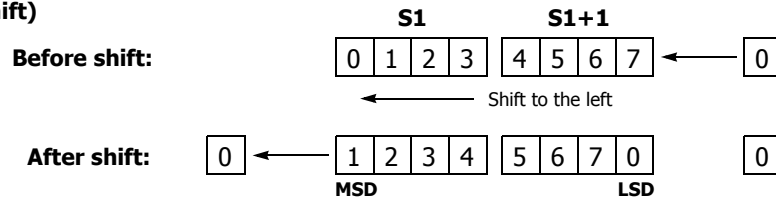

Applicable SmartAXIS

| FT1A-12 | FT1A-24 | FT1A-40 | FT1A-48 | FT1A-Touch |
|---------|---------|---------|---------|------------|
| X | X | X | X | X |

Valid Devices

| Device | Function | I | Q | M | R | T | C | D | Constant | Repeat |
|---------------|-----------------------------|---|---|---|---|---|---|---|----------|--------|
| S1 (Source 1) | Data for BCD shift | — | — | — | — | — | — | X | — | — |
| S2 (Source 2) | Quantity of digits to shift | X | X | X | X | X | X | X | 1-7 | — |

For valid device address ranges, see "Device Addresses" on page 3-1.

When T (timer) or C (counter) is used as S2, the timer/counter current value (TC or CC) is displayed.

The number of digits that can be shifted as S2 are 1 through 7.

Make sure that the source data determined by S1 and S1+1 is between 0 and 9999 for each data register. If either source data is over 9999, a user program execution error will result, turning on special internal relay M8004 and the ERR LED on the SmartAXIS. When S2 is higher than 7, a user program execution error will also result.

When a user program execution error occurs, the execution of the instruction is canceled. The data in S1 and S1+1 is left unchanged and the next instruction is executed. For user program execution errors, see "User Program Execution Errors" on page 4-13.

Valid Data Types

| | | |
|------------------------|---|--|
| W (word) | — | When a word device such as D (data register) is assigned as source S1, 2 points (double-word data) are used. |
| I (integer) | — | When a bit device such as I (input), Q (output), M (internal relay), or R (shift register) is assigned as source S2, 16 points are used. |
| D (double word) | X | |
| L (long) | — | |
| F (float) | — | When a word device such as T (timer), C (counter), or D (data register) is assigned as source S2, 1 point is used. |

10: SHIFT / ROTATE INSTRUCTIONS

Example: BCDLS

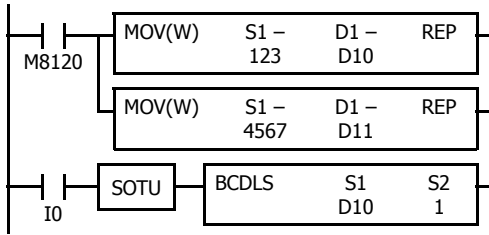

M8120 is the initialize pulse special internal relay.

When the CPU starts operation, the MOV (move) instructions set 123 and 4567 to data registers D10 and D11, respectively.

Each time input I0 is turned on, the 32-bit binary data of data registers D10 and D11 assigned by S1 is converted into 8 BCD digits, shifted to the left by 1 digit as assigned by device S2, and converted back to 32-bit binary data.

Zero is set to the lowest digit after each shift.

When S2 = 1 (digits to shift)

Before shift:

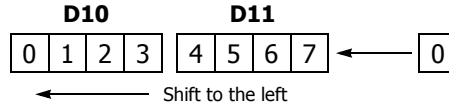

After first shift:

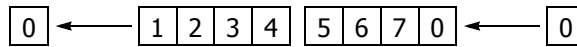

After second shift:

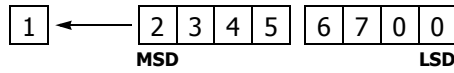

WSFT (Word Shift)

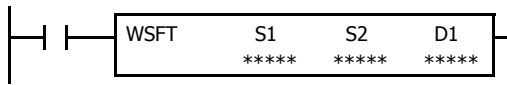

When input is on, N blocks of 16-bit word data, starting with device assigned by D1, are shifted up to the next 16-bit positions. At the same time, the data assigned by device S1 is moved to the device assigned by D1. S2 specifies the quantity of blocks to move.

When S2 = 3 (quantity of blocks to shift)

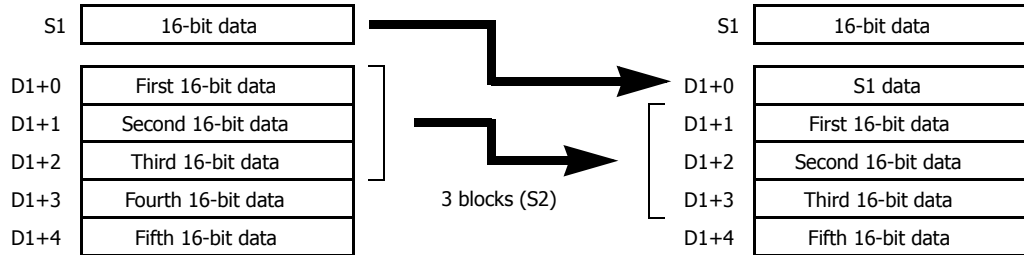

Applicable SmartAXIS

| FT1A-12 | FT1A-24 | FT1A-40 | FT1A-48 | FT1A-Touch |
|---------|---------|---------|---------|------------|
| X | X | X | X | X |

Valid Devices

| Device | Function | I | Q | M | R | T | C | D | Constant | Repeat |
|--------------------|-------------------------------|---|---|---|---|---|---|---|----------|--------|
| S1 (Source 1) | Source data for word shift | X | X | X | X | X | X | X | X | — |
| S2 (Source 2) | Quantity of blocks to shift | X | X | X | X | X | X | X | X | — |
| D1 (Destination 1) | First device address to shift | — | — | — | — | — | — | X | — | — |

For valid device address ranges, see "Device Addresses" on page 3-1.

When T (timer) or C (counter) is used as S1 or S2, the timer/counter current value (TC or CC) is displayed.

Valid Data Types

| | | |
|------------------------|---|--|
| W (word) | X | When a bit device such as I (input), Q (output), M (internal relay), or R (shift register) is assigned as source S1 or S2, 16 points are used. |
| I (integer) | — | |
| D (double word) | — | When a word device such as T (timer), C (counter), or D (data register) is assigned as source S1 or S2, 1 point is used. |
| L (long) | — | |
| F (float) | — | |

Special Internal Relay M8024: BMOV/WSFT Executing Flag

While the BMOV or WSFT is executed, M8024 turns on. When completed, M8024 turns off. If the CPU is powered down while executing BMOV or WSFT, M8024 remains on when the CPU is powered up again.

Example: WSFT



D100 through D102 → D101 through D103

D10 → D100

When input I0 is turned on, data of 3 data registers, starting with D100 assigned by destination device D1, is shifted to the next data registers. Data of data register D10, assigned by source device S1, is moved to D100 assigned by destination device D1.

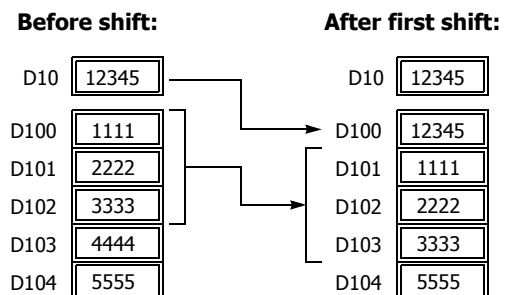

ROTL (Rotate Left)

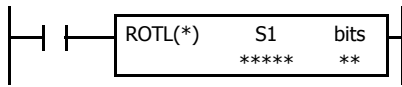

When input is on, 16- or 32-bit data of the assigned source device S1 is rotated to the left by the quantity of bits assigned by device bits.

The result is set to the source device S1, and the last bit status rotated out is set to a carry (special internal relay M8003).

• **Data Type: Word (bits to rotate = 1)**

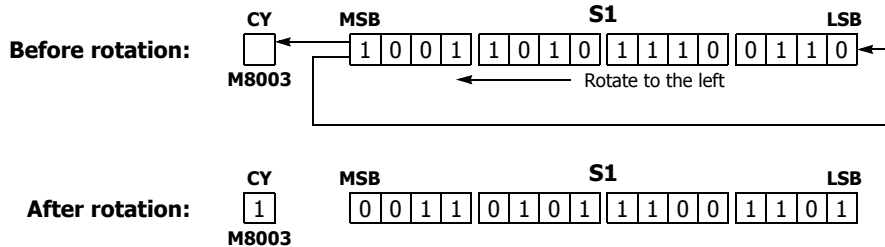

• **Data Type: Double Word (bits to rotate = 1)**

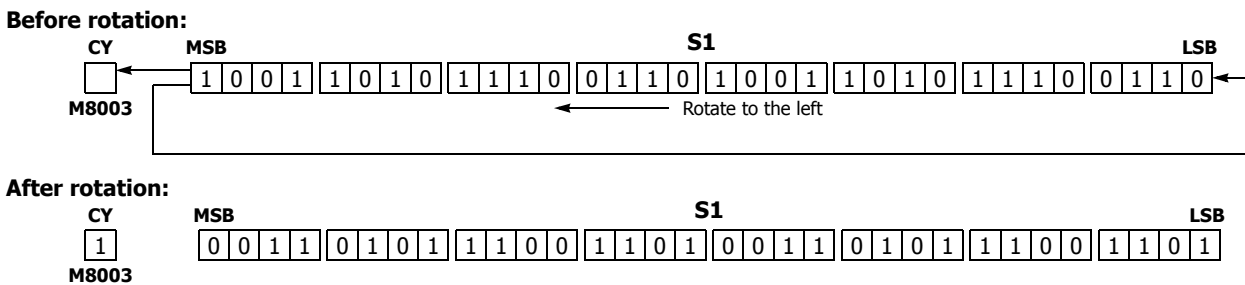

Applicable SmartAXIS

| FT1A-12 | FT1A-24 | FT1A-40 | FT1A-48 | FT1A-Touch |
|---------|---------|---------|---------|------------|
| X | X | X | X | X |

Valid Devices

| Device | Function | I | Q | M | R | T | C | D | Constant | Repeat |
|---------------|----------------------------|---|---|---|---|---|---|---|------------|--------|
| S1 (Source 1) | Data for bit rotation | — | X | ▲ | X | — | — | X | — | — |
| bits | Quantity of bits to rotate | — | — | — | — | — | — | — | 1-15, 1-31 | — |

For valid device address ranges, see "Device Addresses" on page 3-1.

▲ Internal relays M0 through M1277 can be designated as S1. Special internal relays cannot be designated as S1.

The quantity of bits to rotate can be 1 through 15 for word data, or 1 through 31 for double-word data.

Since the ROTL instruction is executed in each scan while input is on, a pulse input from a SOTU or SOTD instruction should be used.

Valid Data Types

| | | |
|------------------------|---|--|
| W (word) | X | When a bit device such as Q (output), M (internal relay), or R (shift register) is assigned as the source, 16 points (word data) or 32 points (double-word data) are used. |
| I (integer) | — | |
| D (double word) | X | When a word device such as D (data register) is assigned as the source, 1 point (word data) or 2 points (double-word data) are used. |
| L (long) | — | |
| F (float) | — | |

Example: ROTL

- Data Type: Word

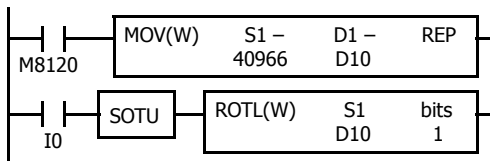

M8120 is the initialize pulse special internal relay.

When the CPU starts operation, the MOV (move) instruction sets 40966 to data register D10.

Each time input I0 is turned on, 16-bit data of data register D10 is rotated to the left by 1 bit as assigned by device bits.

The status of the MSB is set to special internal relay M8003 (carry or borrow).

Bits to rotate = 1

Before rotation: D10 = 40966

After first rotation: D10 = 16397

After second rotation: D10 = 32794

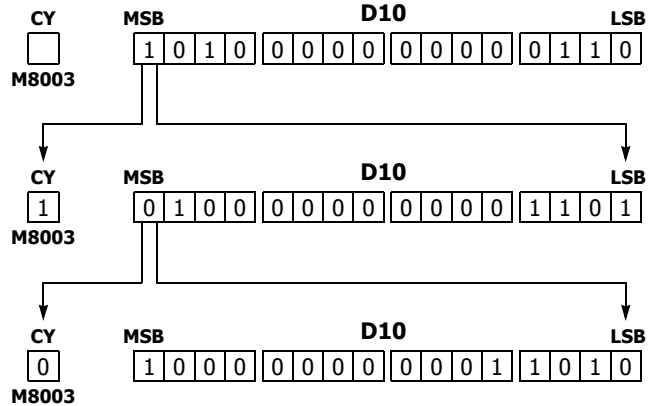

- Data Type: Double Word

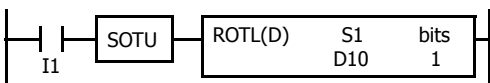

Each time input I1 is turned on, 32-bit data of data registers D10 and D11 is rotated to the left by 1 bit as assigned by device bits.

The status of the MSB is set to special internal relay M8003 (carry or borrow).

Bits to rotate = 1

Before rotation: D10·D11 = 2,684,788,742

After rotation: D10·D11 = 1,074,610,189

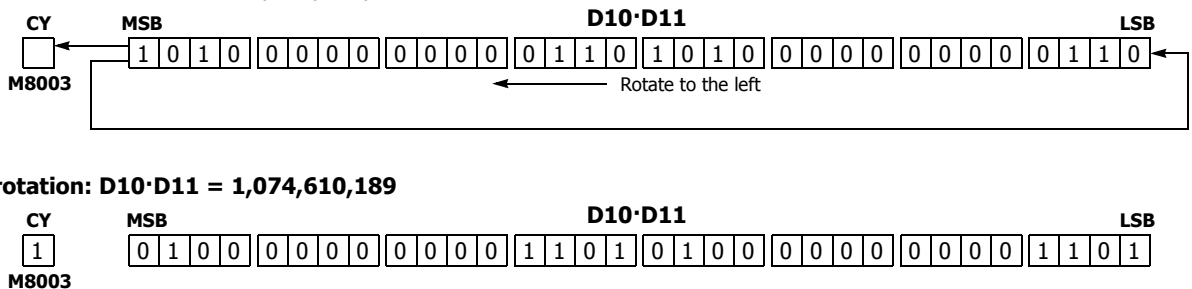

ROTR (Rotate Right)

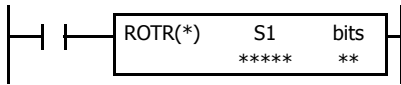

When input is on, 16- or 32-bit data of the assigned source device S1 is rotated to the right by the quantity of bits assigned by device bits.

The result is set to the source device S1, and the last bit status rotated out is set to special internal relay M8003 (carry or borrow).

• **Data Type: Word (bits to rotate = 1)**

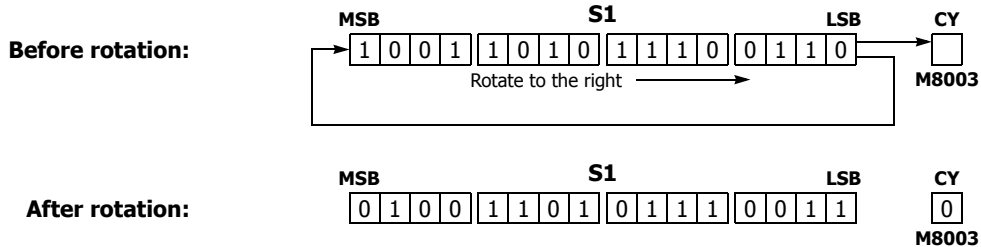

• **Data Type: Double Word (bits to rotate = 1)**

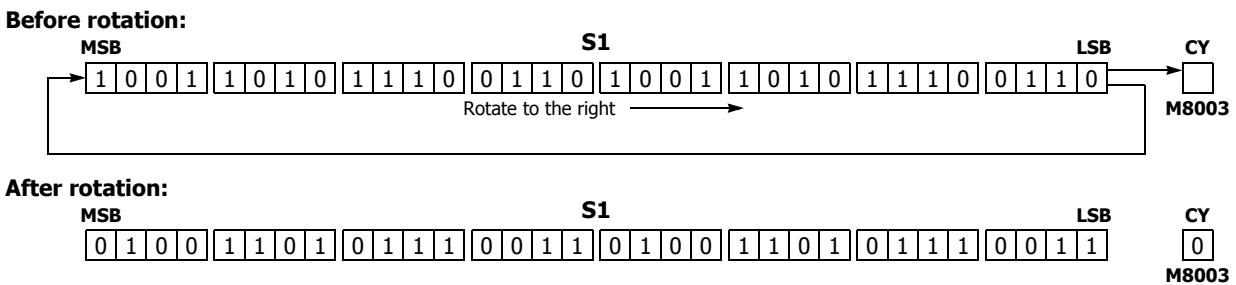

Applicable SmartAXIS

| FT1A-12 | FT1A-24 | FT1A-40 | FT1A-48 | FT1A-Touch |
|---------|---------|---------|---------|------------|
| X | X | X | X | X |

Valid Devices

| Device | Function | I | Q | M | R | T | C | D | Constant | Repeat |
|---------------|----------------------------|---|---|---|---|---|---|---|---------------|--------|
| S1 (Source 1) | Data for bit rotation | — | X | ▲ | X | — | — | X | — | — |
| bits | Quantity of bits to rotate | — | — | — | — | — | — | — | 1-15, 1-31 | — |

For valid device address ranges, see "Device Addresses" on page 3-1.

▲ Internal relays M0 through M1277 can be designated as S1. Special internal relays cannot be designated as S1.

The number of bits that can be rotated is 1 through 15 for word data, or 1 through 31 for double-word data.

Since the ROTR instruction is executed in each scan while input is on, a pulse input from a SOTU or SOTD instruction should be used.

Valid Data Types

| | | |
|------------------------|---|--|
| W (word) | X | When a bit device such as Q (output), M (internal relay), or R (shift register) is assigned as the source, 16 points (word data) or 32 points (double-word data) are used. |
| I (integer) | — | |
| D (double word) | X | When a word device such as D (data register) is assigned as the source, 1 point (word data) or 2 points (double-word data) are used. |
| L (long) | — | |
| F (float) | — | |

Example: ROTR

- Data Type: Word

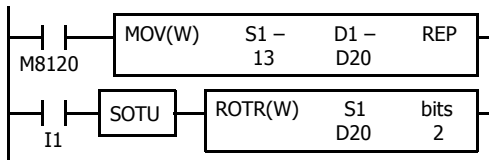

M8120 is the initialize pulse special internal relay.

When the CPU starts operation, the MOV (move) instruction sets 13 to data register D20.

Each time input I1 is turned on, 16-bit data of data register D20 is rotated to the right by 2 bits as assigned by device bits.

The last bit status rotated out is set to special internal relay M8003 (carry or borrow).

Bits to rotate = 2

Before rotation: D20 = 13

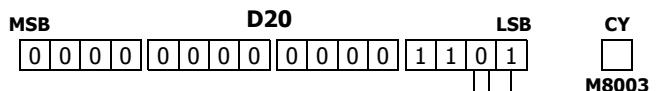

After first rotation: D20 = 16387

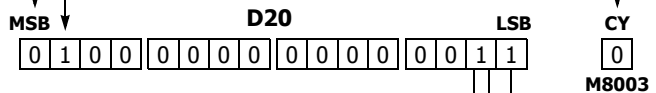

After second rotation: D20 = 53248

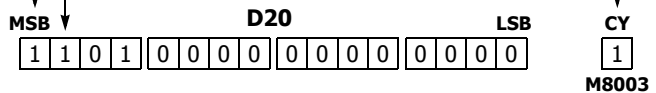

- Data Type: Double Word

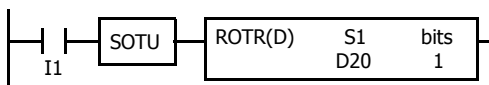

Each time input I1 is turned on, 32-bit data of data registers D20 and D21 is rotated to the right by 1 bit as assigned by device bits.

The last bit status rotated out is set to special internal relay M8003 (carry or borrow).

Bits to rotate = 1

Before rotation: D20·D21 = 851,981

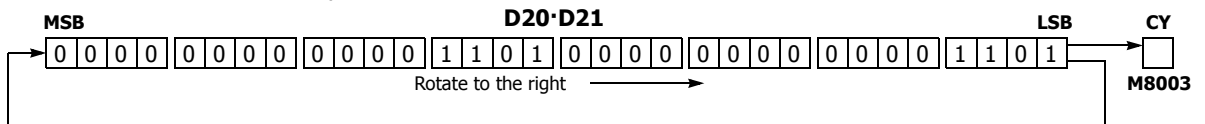

After rotation: D20·D21 = 2,147,909,638

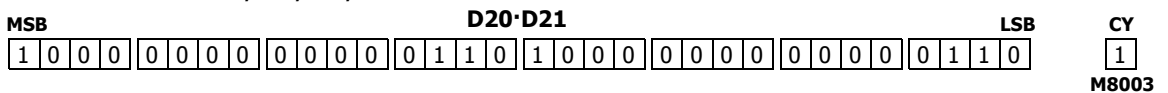

11: DATA CONVERSION INSTRUCTIONS

Introduction

Data conversion instructions convert data to binary, BCD, and ASCII format.

The ENCO (encode), DECO (decode), and BCNT (bit count) instructions processes bit device data.

The ALT (alternate output) instruction turns an output on and off each time an input button is pressed.

The CVDT (convert data) instruction converts data types among W (word), I (integer), D (double word), L (long), and F (float).

The DTDV and DTCB instructions convert data between two one-byte data and one word data. The SWAP exchanges upper and lower byte- or word-data for word- or double-word-data respectively.

HTOB (Hex to BCD)

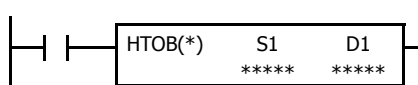

S1 → D1

When input is on, the 16- or 32-bit data assigned by S1 is converted into BCD and stored to the destination assigned by device D1.

Valid values for the source device are 0 through 9999 for word data, and 0 through 9999 9999 for double-word data.

Applicable SmartAXIS

| FT1A-12 | FT1A-24 | FT1A-40 | FT1A-48 | FT1A-Touch |
|---------|---------|---------|---------|------------|
| X | X | X | X | X |

Valid Devices

| Device | Function | I | Q | M | R | T | C | D | Constant | Repeat |
|--------------------|---|---|---|---|---|---|---|---|----------|--------|
| S1 (Source 1) | Binary data to convert | X | X | X | X | X | X | X | X | — |
| D1 (Destination 1) | Destination to store conversion results | — | X | ▲ | X | X | X | X | — | — |

For valid device address ranges, see "Device Addresses" on page 3-1.

▲ Internal relays M0 through M1277 can be designated as D1. Special internal relays cannot be designated as D1.

When T (timer) or C (counter) is used as S1, the timer/counter current value (TC or CC) is displayed. When T (timer) or C (counter) is used as D1, the data is written in as a preset value (TP or CP) which can be 0 through 65535.

Valid values for the source device are 0 through 9999 (270Fh) for word data, and 0 through 9999 9999 (5F5 E0FFh) for double-word data. Make sure that the source designated by S1 is within the valid value range. If the source data exceeds the valid range, a user program execution error will result, turning on special internal relay M8004 and the ERR LED on the SmartAXIS.

When a user program execution error occurs, the execution of the instruction is canceled. The value of D1 is left unchanged and the next instruction is executed. For user program execution errors, see "User Program Execution Errors" on page 4-13.

Since the HTOB instruction is executed in each scan while input is on, a pulse input from a SOTU or SOTD instruction should be used.

Valid Data Types

| | | |
|------------------------|---|---|
| W (word) | X | When a bit device such as I (input), Q (output), M (internal relay), or R (shift register) is assigned as the source, 16 points (word data) or 32 points (double-word data) are used. |
| I (integer) | — | |
| D (double word) | X | When a word device such as T (timer), C (counter), or D (data register) is assigned as the source, 1 point (word data) or 2 points (double-word data) are used. |
| L (long) | — | |
| F (float) | — | |

11: DATA CONVERSION INSTRUCTIONS

Examples: HTOB

- Data Type: Word

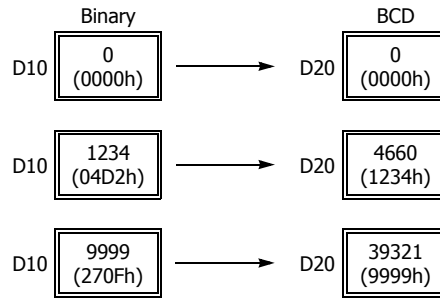
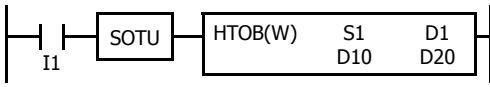

- Data Type: Double Word

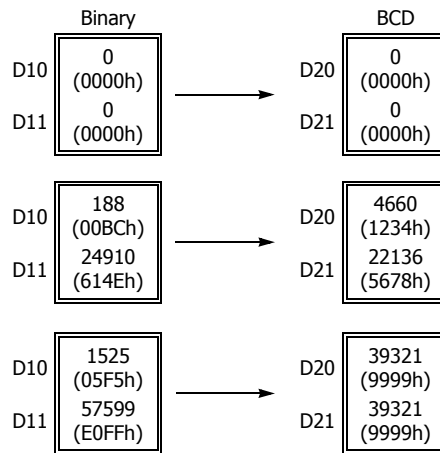
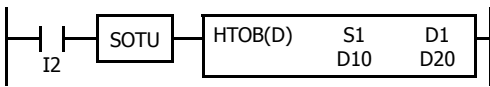

BTOH (BCD to Hex)

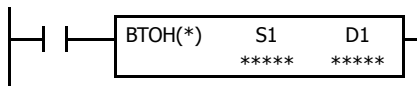

S1 → D1

When input is on, the BCD data assigned by S1 is converted into 16- or 32-bit binary data and stored to the destination assigned by device D1.

Valid values for the source device are 0 through 9999 (BCD) for word data, and 0 through 9999 9999 (BCD) for double-word data.

Applicable SmartAXIS

| FT1A-12 | FT1A-24 | FT1A-40 | FT1A-48 | FT1A-Touch |
|---------|---------|---------|---------|------------|
| X | X | X | X | X |

Valid Devices

| Device | Function | I | Q | M | R | T | C | D | Constant | Repeat |
|--------------------|---|---|---|---|---|---|---|---|----------|--------|
| S1 (Source 1) | BCD data to convert | X | X | X | X | X | X | X | X | — |
| D1 (Destination 1) | Destination to store conversion results | — | X | ▲ | X | X | X | X | — | — |

For valid device address ranges, see "Device Addresses" on page 3-1.

▲ Internal relays M0 through M1277 can be designated as D1. Special internal relays cannot be designated as D1.

When T (timer) or C (counter) is used as S1, the timer/counter current value (TC or CC) is displayed. When T (timer) or C (counter) is used as D1, the data is written in as a preset value (TP or CP) which can be 0 through 65535.

Valid values for the source device are 0 through 9999 (BCD) for word data, and 0 through 9999 9999 (BCD) for double-word data. Make sure that each digit of the source designated by S1 is 0 through 9. If the source data exceeds the valid range, a user program execution error will result, turning on special internal relay M8004 and the ERR LED on the SmartAXIS.

When a user program execution error occurs, the execution of the instruction is canceled. The value of D1 is left unchanged and the next instruction is executed. For user program execution errors, see "User Program Execution Errors" on page 4-13.

Since the BTOH instruction is executed in each scan while input is on, a pulse input from a SOTU or SOTD instruction should be used.

Valid Data Types

| | | |
|------------------------|---|---|
| W (word) | X | When a bit device such as I (input), Q (output), M (internal relay), or R (shift register) is assigned as the source, 16 points (word data) or 32 points (double-word data) are used. |
| I (integer) | — | |
| D (double word) | X | When a word device such as T (timer), C (counter), or D (data register) is assigned as the source, 1 point (word data) or 2 points (double-word data) are used. |
| L (long) | — | |
| F (float) | — | |

11: DATA CONVERSION INSTRUCTIONS

Examples: BTOH

- Data Type: Word

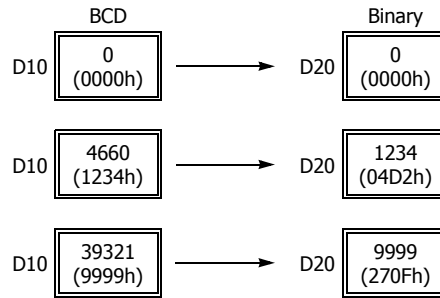
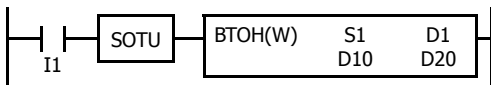

- Data Type: Double Word

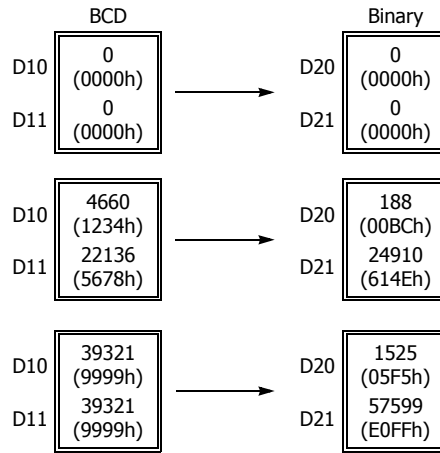
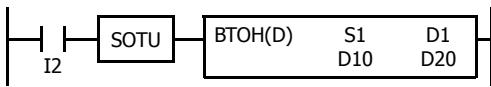

HTOA (Hex to ASCII)

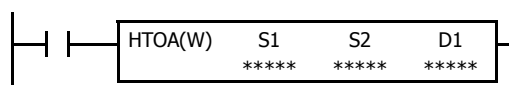

S1 → D1, D1+1, D1+2, D1+3

When input is on, the 16-bit binary data assigned by S1 is read from the lowest digit as many times as the quantity of digits assigned by S2, converted into ASCII data, and stored to the destination starting with the device assigned by D1.

The quantity of digits to convert can be 1 through 4.

Applicable SmartAXIS

| FT1A-12 | FT1A-24 | FT1A-40 | FT1A-48 | FT1A-Touch |
|---------|---------|---------|---------|------------|
| X | X | X | X | X |

Valid Devices

| Device | Function | I | Q | M | R | T | C | D | Constant | Repeat |
|--------------------|---|---|---|---|---|---|---|---|----------|--------|
| S1 (Source 1) | Binary data to convert | X | X | X | X | X | X | X | X | — |
| S2 (Source 2) | Quantity of digits to convert | X | X | X | X | X | X | X | 1-4 | — |
| D1 (Destination 1) | Destination to store conversion results | — | — | — | — | — | — | X | — | — |

For valid device address ranges, see "Device Addresses" on page 3-1.

When T (timer) or C (counter) is used as S1 or S2, the timer/counter current value (TC or CC) is displayed.

The quantity of digits to convert can be 1 through 4. Make sure that the quantity of digits designated by S2 is within the valid range. If the S2 data exceeds the valid range, a user program execution error will result, turning on special internal relay M8004 and the ERR LED on the SmartAXIS.

When a user program execution error occurs, the execution of the instruction is canceled. The value of D1 is left unchanged and the next instruction is executed. For user program execution errors, see "User Program Execution Errors" on page 4-13.

Since the HTOA instruction is executed in each scan while input is on, a pulse input from a SOTU or SOTD instruction should be used.

Valid Data Types

| | | |
|------------------------|---|---|
| W (word) | X | When a bit device such as I (input), Q (output), M (internal relay), or R (shift register) is assigned as the source, 16 points (word data) are used. |
| I (integer) | — | |
| D (double word) | — | When a word device such as T (timer), C (counter), or D (data register) is assigned as the source or destination, 1 point (word data) is used. |
| L (long) | — | |
| F (float) | — | |

11: DATA CONVERSION INSTRUCTIONS

Examples: HTOA

- Quantity of Digits: 4

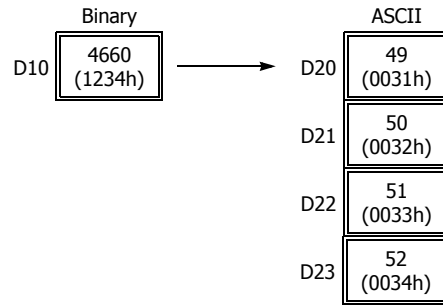
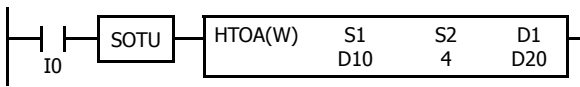

- Quantity of Digits: 3

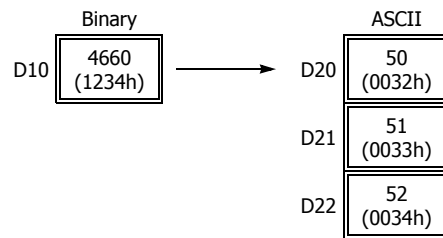
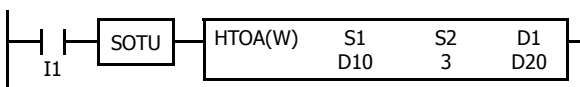

- Quantity of Digits: 2

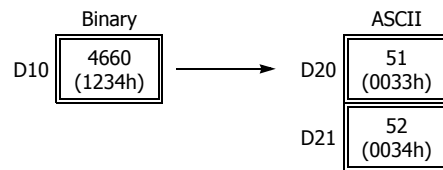
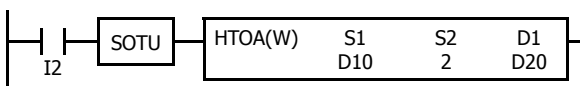

- Quantity of Digits: 1

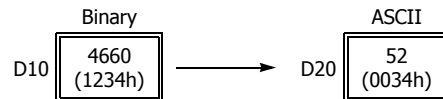
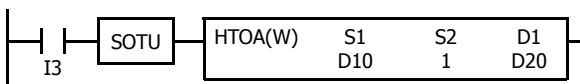

ATOH (ASCII to Hex)

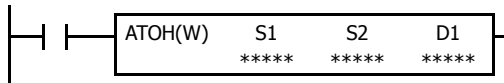

S1, S1+1, S1+2, S1+3 → D1

When input is on, the ASCII data, assigned by S1, is converted into 16-bit binary data. The number of times is determined by the quantity of digits assigned by S2. The data is then stored to the destination assigned by device D1.

Valid values for source data to convert are 30h to 39h and 41h to 46h.

The quantity of digits to convert can be 1 through 4.

Applicable SmartAXIS

| FT1A-12 | FT1A-24 | FT1A-40 | FT1A-48 | FT1A-Touch |
|---------|---------|---------|---------|------------|
| X | X | X | X | X |

Valid Devices

| Device | Function | I | Q | M | R | T | C | D | Constant | Repeat |
|--------------------|---|---|---|---|---|---|---|---|----------|--------|
| S1 (Source 1) | ASCII data to convert | — | — | — | — | — | — | X | — | — |
| S2 (Source 2) | Quantity of digits to convert | X | X | X | X | X | X | X | 1-4 | — |
| D1 (Destination 1) | Destination to store conversion results | — | X | ▲ | X | X | X | X | — | — |

For valid device address ranges, see "Device Addresses" on page 3-1.

▲ Internal relays M0 through M1277 can be designated as D1. Special internal relays cannot be designated as D1.

When T (timer) or C (counter) is used as S2, the timer/counter current value (TC or CC) is displayed. When T (timer) or C (counter) is used as D1, the data is written in as a preset value (TP or CP) which can be 0 through 65535.

Valid values for source S1 data to convert are 30h to 39h and 41h to 46h. Make sure that the values for each source designated by S1 and the quantity of digits designated by S2 are within the valid range. If the S1 or S2 data exceeds the valid range, a user program execution error will result, turning on special internal relay M8004 and the ERR LED on the SmartAXIS.

When a user program execution error occurs, the execution of the instruction is canceled. The value of D1 is left unchanged and the next instruction is executed. For user program execution errors, see "User Program Execution Errors" on page 4-13.

Since the ATOH instruction is executed in each scan while input is on, a pulse input from a SOTU or SOTD instruction should be used.

Valid Data Types

| | | |
|------------------------|---|--|
| W (word) | X | When a bit device such as I (input), Q (output), M (internal relay), or R (shift register) is assigned as the source or destination, 16 points (word data) are used. |
| I (integer) | — | |
| D (double word) | — | When a word device such as T (timer), C (counter), or D (data register) is assigned as the source or destination, 1 point (word data) is used. |
| L (long) | — | |
| F (float) | — | |

11: DATA CONVERSION INSTRUCTIONS

Examples: ATOH

- Quantity of Digits: 4

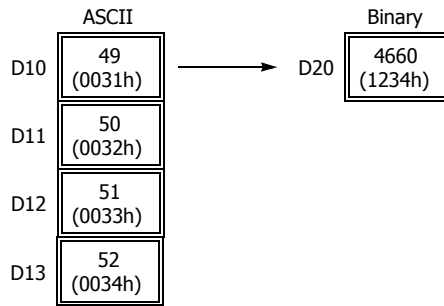
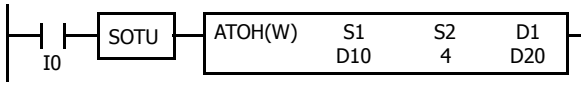

- Quantity of Digits: 3

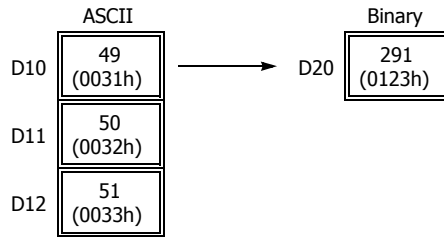
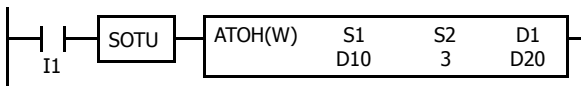

- Quantity of Digits: 2

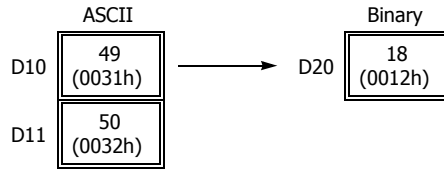
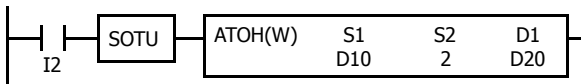

- Quantity of Digits: 1

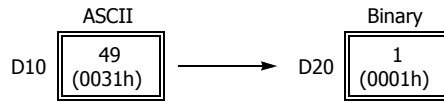
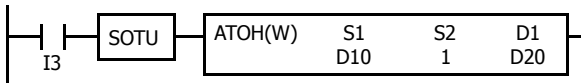

BTOA (BCD to ASCII)

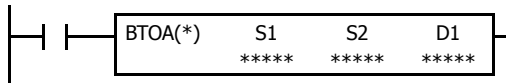

Word data: S1 → D1, D1+1, D1+2, D1+3, D1+4
 Double-word data: S1:S1+1 → D1, D1+1, D1+2, ..., D1+9
 When input is on, the 16- or 32-bit binary data assigned by S1 is converted into BCD, and converted into ASCII data. The data is read from the lowest digit as many times as the quantity of digits assigned by S2. The result is stored to the destination starting with the device assigned by D1.

The number of digits that can be converted is 1 through 5 for word data, and 1 through 10 for double-word data.

Applicable SmartAXIS

| FT1A-12 | FT1A-24 | FT1A-40 | FT1A-48 | FT1A-Touch |
|---------|---------|---------|---------|------------|
| X | X | X | X | X |

Valid Devices

| Device | Function | I | Q | M | R | T | C | D | Constant | Repeat |
|--------------------|---|---|---|---|---|---|---|---|-----------|--------|
| S1 (Source 1) | Binary data to convert | X | X | X | X | X | X | X | X | — |
| S2 (Source 2) | Quantity of digits to convert | X | X | X | X | X | X | X | 1-5, 1-10 | — |
| D1 (Destination 1) | Destination to store conversion results | — | — | — | — | — | — | X | — | — |

For valid device address ranges, see "Device Addresses" on page 3-1.

When T (timer) or C (counter) is used as S1 or S2, the timer/counter current value (TC or CC) is displayed.

The number of digits that can be converted is 1 through 5 for word data, and 1 through 10 for double-word data. Make sure that the quantity of digits designated by S2 is within the valid range. If the S2 data exceeds the valid range, a user program execution error will result, turning on special internal relay M8004 and the ERR LED on the SmartAXIS.

Make sure that the last destination data determined by D1+S2-1 is within the valid device range. If the derived destination device exceeds the valid device range, a user program execution error will result, turning on special internal relay M8004 and ERROR LED on the SmartAXIS.

When a user program execution error occurs, the execution of the instruction is canceled. The value of D1 is left unchanged and the next instruction is executed. For user program execution errors, see "User Program Execution Errors" on page 4-13.

Since the BTOA instruction is executed in each scan while input is on, a pulse input from a SOTU or SOTD instruction should be used.

Valid Data Types

| | | |
|------------------------|---|---|
| W (word) | X | When a bit device such as I (input), Q (output), M (internal relay), or R (shift register) is assigned as the source, 16 points (word data) or 32 points (double-word data) are used. |
| I (integer) | — | |
| D (double word) | X | When a word device such as T (timer), C (counter), or D (data register) is assigned as the source or destination, 1 point (word data) or 2 points (double-word data) are used. |
| L (long) | — | |
| F (float) | — | |

11: DATA CONVERSION INSTRUCTIONS

Examples: BTOA(W)

- Quantity of Digits: 5

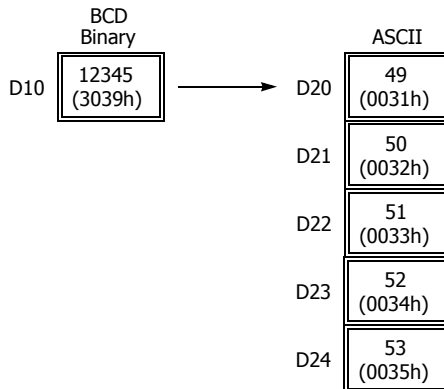
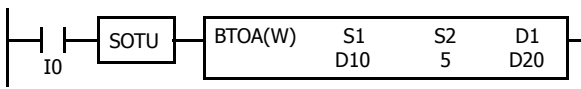

- Quantity of Digits: 4

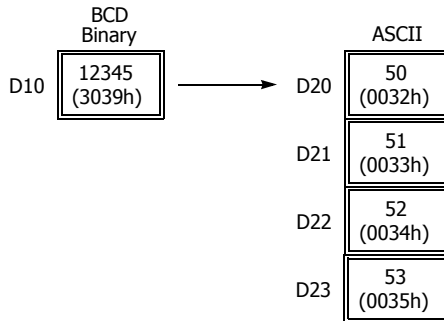
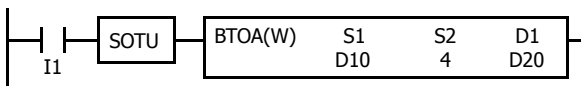

- Quantity of Digits: 3

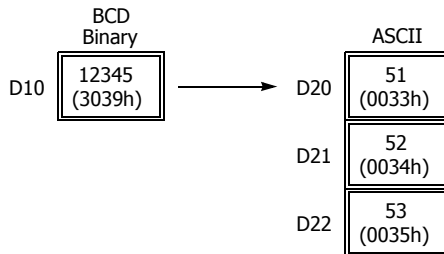
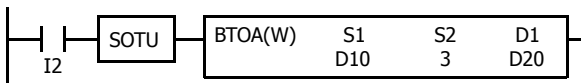

- Quantity of Digits: 2

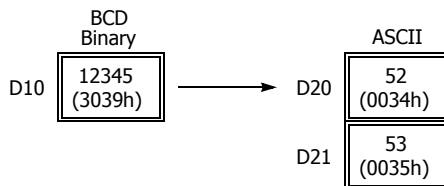
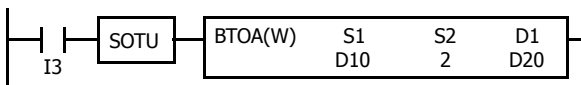

- Quantity of Digits: 1

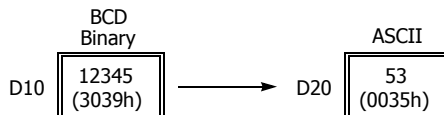
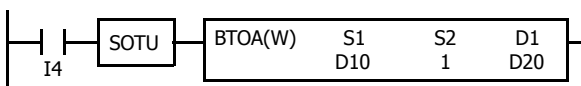

Examples: BTOA(D)

- Quantity of Digits: 10

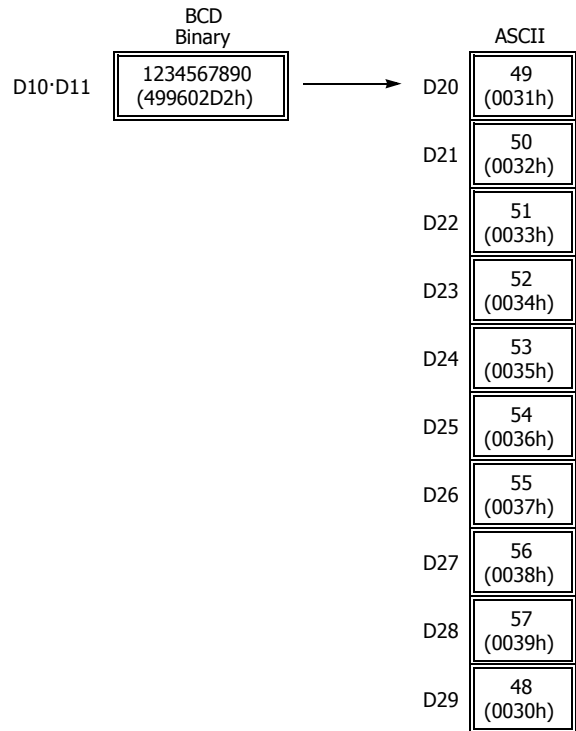
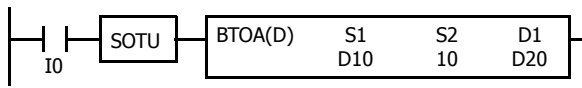

- Quantity of Digits: 6

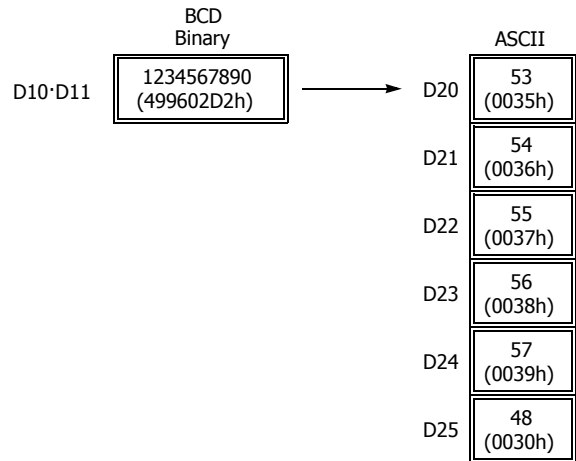
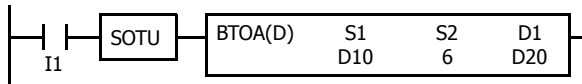

- Quantity of Digits: 3

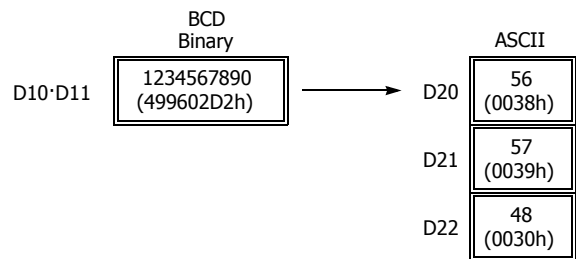
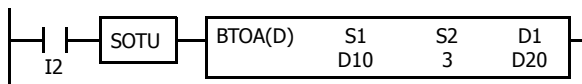

11: DATA CONVERSION INSTRUCTIONS

ATOB (ASCII to BCD)

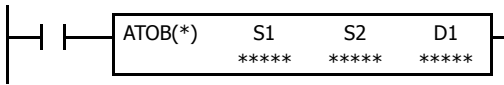

Word data: S1, S1+1, S1+2, S1+3, S1+4 → D1
 Double-word data: S1, S1+1, S1+2, ... , S1+9 → D1·D1+1

When input is on, the ASCII data assigned by S1 as many times as the quantity of digits assigned by S2 is converted into BCD, and converted into 16- or 32-bit binary data. The result is stored to the destination assigned by device D1.

Valid values for source data to convert are 30h through 39h.

The number of digits that can be converted is through 5 for word data, and 1 through 10 for double-word data.

Applicable SmartAXIS

| FT1A-12 | FT1A-24 | FT1A-40 | FT1A-48 | FT1A-Touch |
|---------|---------|---------|---------|------------|
| X | X | X | X | X |

Valid Devices

| Device | Function | I | Q | M | R | T | C | D | Constant | Repeat |
|--------------------|---|---|---|---|---|---|---|---|-----------|--------|
| S1 (Source 1) | ASCII data to convert | — | — | — | — | — | — | X | — | — |
| S2 (Source 2) | Quantity of digits to convert | X | X | X | X | X | X | X | 1-5, 1-10 | — |
| D1 (Destination 1) | Destination to store conversion results | — | X | ▲ | X | X | X | X | — | — |

For valid device address ranges, see "Device Addresses" on page 3-1.

▲ Internal relays M0 through M1277 can be designated as D1.

When T (timer) or C (counter) is used as S2, the timer/counter current value (TC or CC) is displayed. When T (timer) or C (counter) is used as D1, the data is written in as a preset value (TP or CP).

Valid values for source S1 data to convert are 30h through 39h. The number of digits that can be converted is be 1 through 5 for word data, and 1 through 10 for double-word data. Make sure that the values for each source designated by S1 and the quantity of digits designated by S2 are within the valid range. If the S1 or S2 data exceeds the valid range, a user program execution error will result, turning on special internal relay M8004 and the ERR LED on the SmartAXIS.

Make sure that the last source data determined by S1+S2-1 is within the valid device range. If the derived source device exceeds the valid device range, a user program execution error will result, turning on special internal relay M8004 and ERROR LED on the SmartAXIS.

When a user program execution error occurs, the execution of the instruction is canceled. The value of D1 is left unchanged and the next instruction is executed. For user program execution errors, see "User Program Execution Errors" on page 4-13.

Since the ATOB instruction is executed in each scan while input is on, a pulse input from a SOTU or SOTD instruction should be used.

Valid Data Types

| | | |
|------------------------|---|--|
| W (word) | X | When a bit device such as I (input), Q (output), M (internal relay), or R (shift register) is assigned as the source or destination, 16 points (word data) or 32 points (double-word data) are used. |
| I (integer) | — | |
| D (double word) | X | When a word device such as T (timer), C (counter), or D (data register) is assigned as the source or destination, 1 point (word data) or 2 points (double-word data) are used. |
| L (long) | — | |
| F (float) | — | |

Examples: ATOB(W)

- Quantity of Digits: 5

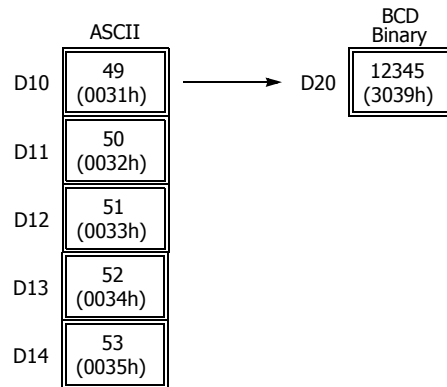
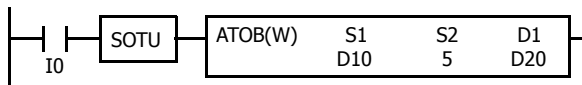

- Quantity of Digits: 4

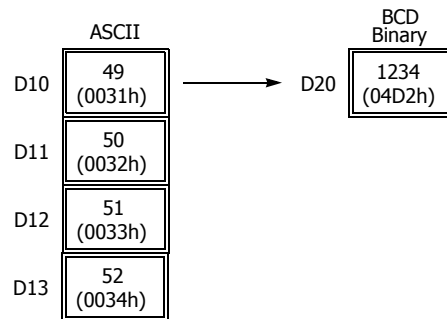
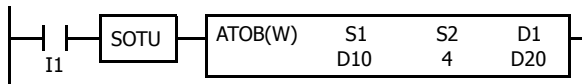

- Quantity of Digits: 3

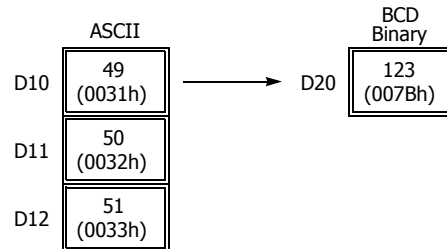
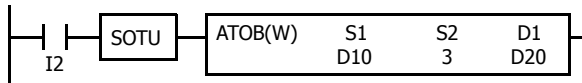

- Quantity of Digits: 2

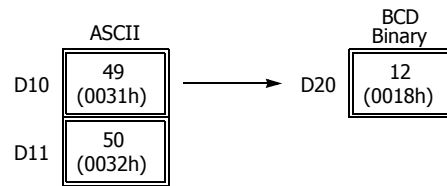
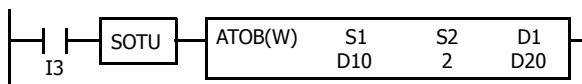

- Quantity of Digits: 1

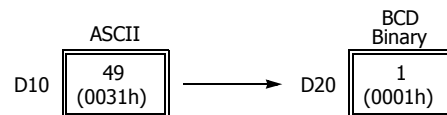
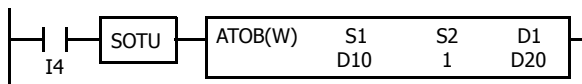

11: DATA CONVERSION INSTRUCTIONS

Examples: ATOB(D)

- Quantity of Digits: 10

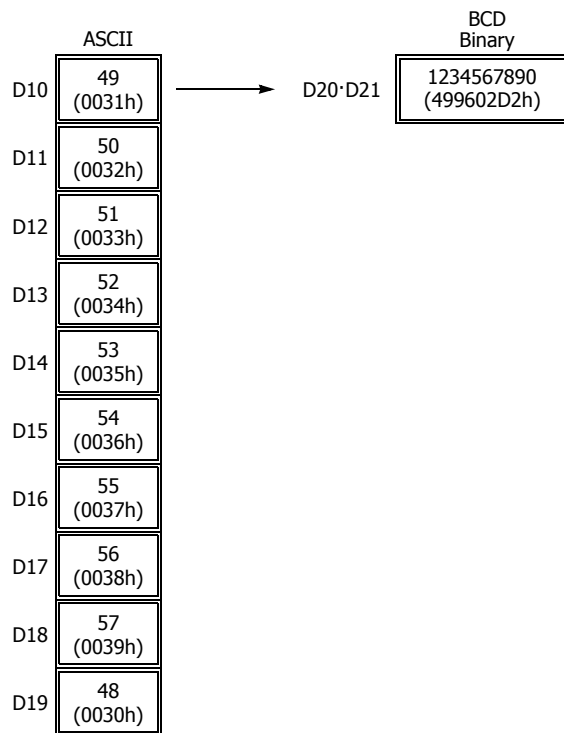
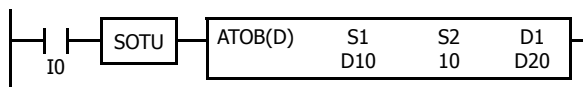

- Quantity of Digits: 6

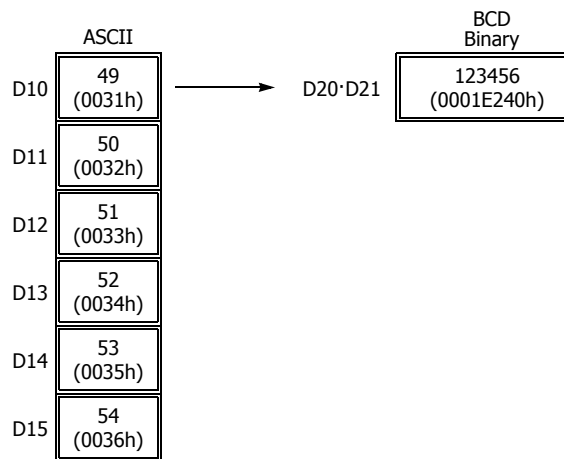
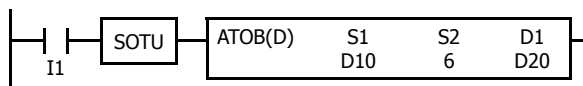

- Quantity of Digits: 3

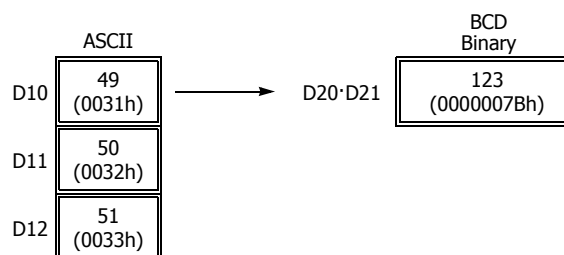
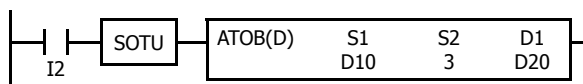

ENCO (Encode)



When input is on, a search begins for the first bit that is set on. The search begins at S1 until the first set (on) point is located. The number of points from S1 to the first set point (offset) is stored to the destination assigned by device D1.

If no point is on in the searched area, 65535 is stored to D1.

Applicable SmartAXIS

| FT1A-12 | FT1A-24 | FT1A-40 | FT1A-48 | FT1A-Touch |
|---------|---------|---------|---------|------------|
| X | X | X | X | X |

Valid Devices

| Device | Function | I | Q | M | R | T | C | D | Constant | Repeat |
|--------------------|-------------------------------------|---|---|---|---|---|---|---|----------|--------|
| S1 (Source 1) | First bit to start search | X | X | X | X | — | — | X | — | — |
| D1 (Destination 1) | Destination to store search results | — | X | ▲ | X | — | — | X | — | — |
| Bits | Quantity of bits searched | — | — | — | — | — | — | — | 1-256 | — |

For valid device address ranges, see "Device Addresses" on page 3-1.

▲ Internal relays M0 through M1277 can be designated as D1. Special internal relays cannot be designated as D1.

Valid values for Bits to designate the quantity of bits searched are 1 through 256. Make sure that the search area designated by S1 plus Bits is within the valid value range. If the source data exceeds the valid range, a user program execution error will result, turning on special internal relay M8004 and the ERR LED on the SmartAXIS.

When a user program execution error occurs, the execution of the instruction is canceled. The value of D1 is left unchanged and the next instruction is executed. For user program execution errors, see "User Program Execution Errors" on page 4-13.

Since the ENCO instruction is executed in each scan while input is on, a pulse input from a SOTU or SOTD instruction should be used.

Examples: ENCO



When input I0 is on, a search begins for a bit that is set on in an array of 64 bits starting at internal relay M4 assigned by device S1.

Since internal relay M30 is the first point that is on, the offset from the first search point is 20, and 20 is stored to data register D100 assigned by device D1.

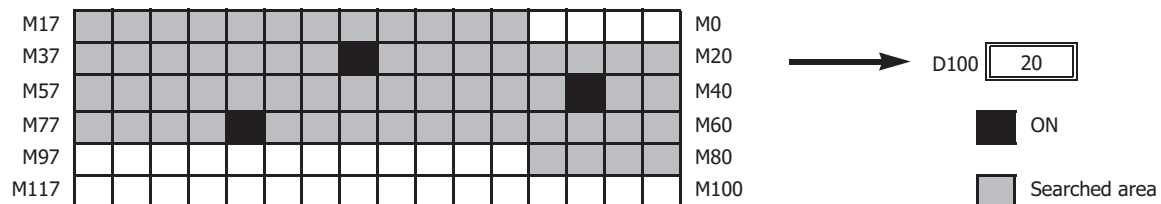

When input I1 is on, a search begins for a bit that is set on in an array of 64 bits starting at bit 0 of data register D10 assigned by device S1.

Since bit 8 of data register D11 is the first point that is on, the offset from the first search point is 24, and 24 is stored to data register D100 assigned by device D1.

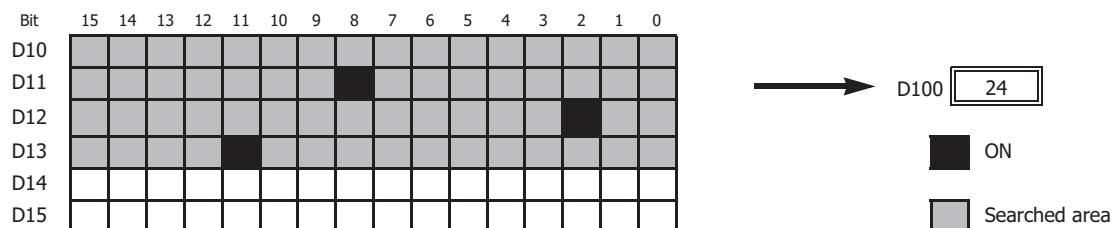

11: DATA CONVERSION INSTRUCTIONS

DECO (Decode)



When input is on, the values contained in devices assigned by S1 and D1 are added together to determine the destination, and the bit is then turned on.

Applicable SmartAXIS

| FT1A-12 | FT1A-24 | FT1A-40 | FT1A-48 | FT1A-Touch |
|---------|---------|---------|---------|------------|
| X | X | X | X | X |

Valid Devices

| Device | Function | I | Q | M | R | T | C | D | Constant | Repeat |
|--------------------|---------------------------|---|---|---|---|---|---|---|----------|--------|
| S1 (Source 1) | Offset | X | X | X | X | — | — | X | 0-255 | — |
| D1 (Destination 1) | First bit to count offset | — | X | ▲ | X | — | — | X | — | — |

For valid device address ranges, see "Device Addresses" on page 3-1.

▲ Internal relays M0 through M1277 can be designated as D1. Special internal relays cannot be designated as D1.

Valid values for the offset designated by source device S1 are 0 through 255. Make sure that the offset designated by S1 and the last bit of destination data determined by the sum of S1 and D1 are within the valid value range. If the offset or destination data exceeds the valid range, a user program execution error will result, turning on special internal relay M8004 and the ERR LED on the SmartAXIS.

When a user program execution error occurs, the execution of the instruction is canceled. The value of D1 is left unchanged and the next instruction is executed. For user program execution errors, see "User Program Execution Errors" on page 4-13.

Since the DECO instruction is executed in each scan while input is on, a pulse input from a SOTU or SOTD instruction should be used.

Examples: DECO

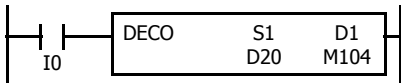

When input I0 is on, the destination bit is determined by adding the value contained in data register D20 assigned by device S1 to internal relay M104 assigned by destination device D1.

Since the 19th bit from internal relay M104 is internal relay M127, the bit is then turned on.

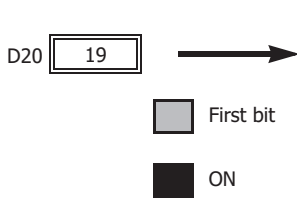

| | | | | | | | | | | | | | | | | | | | | | | |
|------|--|--|--|--|--|--|--|--|--|--|--|--|--|--|--|--|--|--|--|--|------|------|
| M117 | | | | | | | | | | | | | | | | | | | | | M100 | |
| M137 | | | | | | | | | | | | | | | | | | | | | | M120 |
| M157 | | | | | | | | | | | | | | | | | | | | | | M140 |
| M177 | | | | | | | | | | | | | | | | | | | | | | M160 |
| M197 | | | | | | | | | | | | | | | | | | | | | | M180 |
| M217 | | | | | | | | | | | | | | | | | | | | | | M200 |

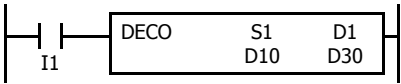

When input I1 is on, the destination bit is determined by adding the value contained in data register D10 assigned by device S1 to data register D30 assigned by destination device D1.

Since the 39th bit from data register D30 bit 0 is data register D32 bit 7, the bit is then turned on.



| Bit | 15 | 14 | 13 | 12 | 11 | 10 | 9 | 8 | 7 | 6 | 5 | 4 | 3 | 2 | 1 | 0 |
|-----|----|----|----|----|----|----|---|---|---|---|---|---|---|---|---|---|
| D30 | | | | | | | | | | | | | | | | |
| D31 | | | | | | | | | | | | | | | | |
| D32 | | | | | | | | | | | | | | | | |
| D33 | | | | | | | | | | | | | | | | |
| D34 | | | | | | | | | | | | | | | | |
| D35 | | | | | | | | | | | | | | | | |

BCNT (Bit Count)

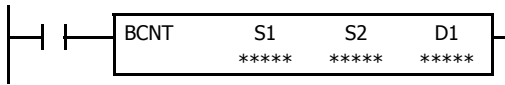

When input is on, a search begins for the total number of bits that are on an array of consecutive bits starting at the point assigned by source device S1. Source device S2 assigns the quantity of bits searched. The quantity of bits which are on is stored to the destination assigned by device D1.

Applicable SmartAXIS

| FT1A-12 | FT1A-24 | FT1A-40 | FT1A-48 | FT1A-Touch |
|---------|---------|---------|---------|------------|
| X | X | X | X | X |

Valid Devices

| Device | Function | I | Q | M | R | T | C | D | Constant | Repeat |
|--------------------|--|---|---|---|---|---|---|---|----------|--------|
| S1 (Source 1) | First bit to start search | X | X | X | X | — | — | X | — | — |
| S2 (Source 2) | Quantity of bits searched | X | X | X | X | X | X | X | 1-256 | — |
| D1 (Destination 1) | Destination to store quantity of ON bits | — | X | ▲ | X | X | X | X | — | — |

For valid device address ranges, see "Device Addresses" on page 3-1.

▲ Internal relays M0 through M1277 can be designated as D1. Special internal relays cannot be designated as D1.

When T (timer) or C (counter) is used as S2, the timer/counter current value (TC or CC) is displayed. When T (timer) or C (counter) is used as D1, the data is written in as a preset value (TP or CP) which can be 0 through 65535.

Valid values for S2 to designate as the number of bits that can be searched is 1 through 256. Make sure that the search area designated by S1 plus S2 is within the valid value range. If the source data exceeds the valid range, a user program execution error will result, turning on special internal relay M8004 and the ERR LED on the SmartAXIS.

When a user program execution error occurs, the execution of the instruction is canceled. The value of D1 is left unchanged and the next instruction is executed. For user program execution errors, see "User Program Execution Errors" on page 4-13.

Since the BCNT instruction is executed in each scan while input is on, a pulse input from a SOTU or SOTD instruction should be used.

Examples: BCNT

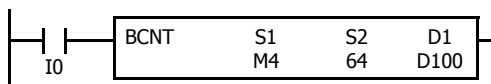

When input is on, a search begins for the total number of bits that are on in an array of 64 bits starting at internal relay M4 assigned by source device S1.

Since 3 bits are on in the searched area, the quantity is stored to data register D100 assigned by destination device D1.

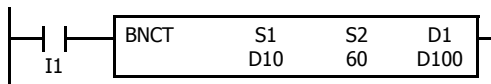
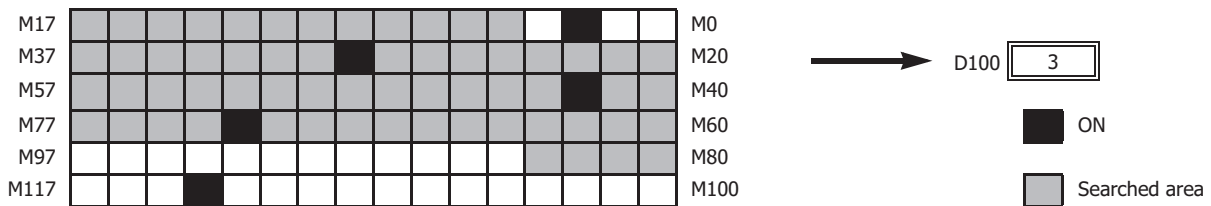

When input I0 is on, a search begins for the total number of bits that are on in an array of 60 bits starting at bit 0 of data register D10 assigned by device S1.

Since 2 bits are on among the 60 bits, 2 is stored to data register D100 assigned by device D1.

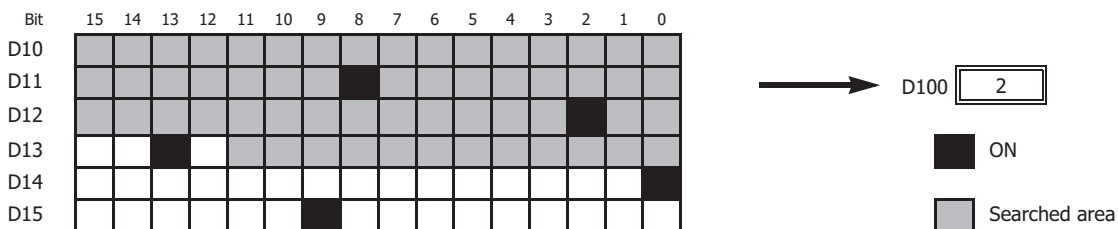

ALT (Alternate Output)

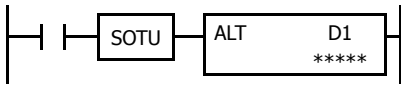

When input is turned on, output, internal relay, or shift register bit assigned by D1 is turned on and remains on after the input is turned off.

When input is turned on again, the assigned output, internal relay, or shift register bit is turned off.

The ALT instruction must be used with a SOTU or SOTD instruction, otherwise the assigned output, internal relay, or shift register bit repeats to turn on and off in each scan.

Applicable SmartAXIS

| FT1A-12 | FT1A-24 | FT1A-40 | FT1A-48 | FT1A-Touch |
|---------|---------|---------|---------|------------|
| X | X | X | X | X |

Valid Devices

| Device | Function | I | Q | M | R | T | C | D | Constant | Repeat |
|--------------------|------------------------|---|---|---|---|---|---|---|----------|--------|
| D1 (Destination 1) | Bit to turn on and off | — | X | X | X | — | — | — | — | — |

For valid device address ranges, see "Device Addresses" on page 3-1.

Since the ALT instruction is executed in each scan while input is on, a pulse input from a SOTU or SOTD instruction must be used. For the SOTU instruction and the SOTD instruction, see "SOTU and SOTD (Single Output Up and Down)" on page 5-26.

Example: ALT

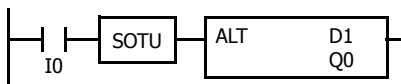

When input I0 is turned on, output Q0 assigned by device D1 is turned on and remains after input I0 is turned off.

When input I0 is turned on again, output Q0 is turned off.

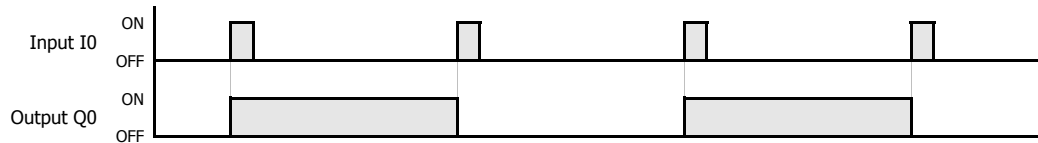

CVDT (Convert Data Type)

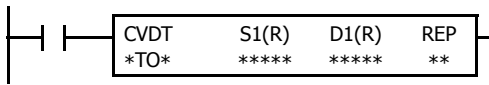

S1 → D1

When input is on, the data type of the 16- or 32-bit data assigned by S1 is converted and stored to the destination assigned by device D1.

Data types can be assigned for the source and destination, separately

| Data Type | W, I | D, L, F |
|-------------|------|---------|
| Source | S1 | S1·S1+1 |
| Destination | D1 | D1·D1+1 |

When the same data type is assigned for both source and destination, the CVDT instruction has the same function as the MOV instruction.

Unless F (float) data is selected for both source and destination, only the integral number is moved, omitting the fraction.

When the source data exceeds the range of destination data, the destination stores a value closest to the source data within the destination data.

Applicable SmartAXIS

| FT1A-12 | FT1A-24 | FT1A-40 | FT1A-48 | FT1A-Touch |
|---------|---------|---------|---------|------------|
| X | X | X | X | X |

Valid Devices

| Device | Function | I | Q | M | R | T | C | D | Constant | Repeat |
|--------------------|--|---|---|---|---|---|---|---|----------|--------|
| S1 (Source 1) | First device address to convert data type | X | X | X | X | X | X | X | X | 1-99 |
| D1 (Destination 1) | First device address to store converted data | — | X | ▲ | X | X | X | X | — | 1-99 |

For valid device address ranges, see "Device Addresses" on page 3-1.

▲ Internal relays M0 through M1277 can be designated as D1. Special internal relays cannot be designated as D1.

When T (timer) or C (counter) is used as S1, the timer/counter current value (TC or CC) is displayed. When T (timer) or C (counter) is used as D1, the data is written in as a preset value (TP or CP) which can be 0 through 65535.

When F (float) data is selected, only data register and constant can be designated as S1 and only data register can be designated as D1.

When F (float) data is selected and S1 or D1 does not comply with the normal floating-point format, a user program execution error will result, turning on special internal relay M8004 and ERR LED on the SmartAXIS.

When a user program execution error occurs, the execution of the instruction is canceled. The value of D1 is left unchanged and the next instruction is executed. For user program execution errors, see "User Program Execution Errors" on page 4-13.

Valid Data Types

| | | |
|------------------------|---|--|
| W (word) | X | When a bit device such as I (input), Q (output), M (internal relay), or R (shift register) is assigned as the source or destination, 16 points (word or integer data) or 32 points (double-word, long, or float data) are used. When repeat is assigned for a bit device, the quantity of device bits increases in 16- or 32-point increments. |
| I (integer) | X | |
| D (double word) | X | |
| L (long) | X | When a word device such as T (timer), C (counter), or D (data register) is assigned as the source or destination, 1 point (word or integer data) or 2 points (double-word, long, or float data) are used. When repeat is assigned for a word device, the quantity of device words increases in 1- or 2-point increments. |
| F (float) | X | |

11: DATA CONVERSION INSTRUCTIONS

Examples: CVDT

- Data Type: Either S1 or D1 is not F (float)**

Unless F (float) data is selected for both source and destination, only the integral number is moved, omitting the fraction.

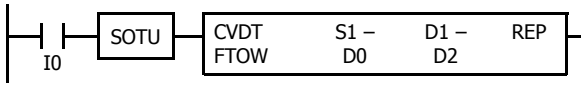

| Device | Data Type | Value |
|-------------|-----------|----------|
| Source | F | 3.141593 |
| Destination | W | 3 |

When input I0 is turned on, 3 is stored to data register D2.

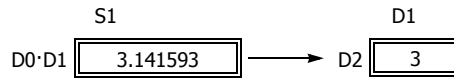

- Data Type: S1 has a larger data range than D1**

When the source data exceeds the range of destination data type, the destination stores a value closest to the source data within the destination data type.

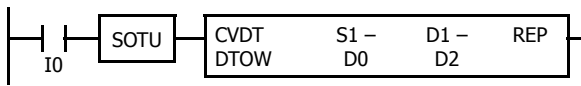

| Device | Data Type | Value |
|-------------|-----------|------------|
| Source | D | 4294967295 |
| Destination | W | 65535 |

When input I0 is turned on, 65535 is stored to data register D2.

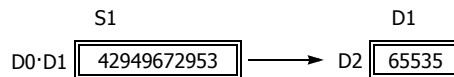

DTDV (Data Divide)

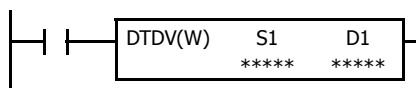

S1 → D1, D1+1

When input is on, the 16-bit binary data assigned by S1 is divided into upper and lower bytes. The upper byte data is stored to the destination assigned by device D1. The lower byte data is stored to the device next to D1.

Applicable SmartAXIS

| FT1A-12 | FT1A-24 | FT1A-40 | FT1A-48 | FT1A-Touch |
|---------|---------|---------|---------|------------|
| X | X | X | X | X |

Valid Devices

| Device | Function | I | Q | M | R | T | C | D | Constant | Repeat |
|--------------------|------------------------------|---|---|---|---|---|---|---|----------|--------|
| S1 (Source 1) | Binary data to divide | X | X | X | X | X | X | X | X | — |
| D1 (Destination 1) | Destination to store results | — | — | — | — | — | — | X | — | — |

For valid device address ranges, see "Device Addresses" on page 3-1.

When T (timer) or C (counter) is used as S1, the timer/counter current value (TC or CC) is displayed.

Destination device D1 uses 2 data registers starting with the device assigned by D1.

Since the DTDV instruction is executed in each scan while input is on, a pulse input from a SOTU or SOTD instruction should be used.

Valid Data Types

| | | |
|------------------------|---|---|
| W (word) | X | When a bit device such as I (input), Q (output), M (internal relay), or R (shift register) is assigned as the source, 16 points (word data) are used. |
| I (integer) | — | |
| D (double word) | — | When a word device such as T (timer), C (counter), or D (data register) is assigned as the source or destination, 1 point (word data) is used. |
| L (long) | — | |
| F (float) | — | |

Example: DTDV

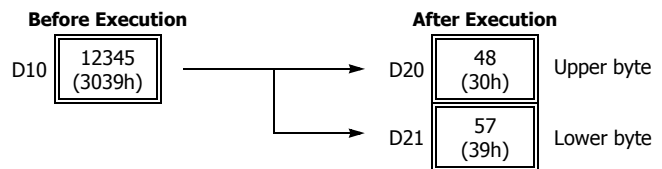
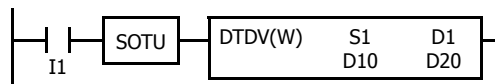

11: DATA CONVERSION INSTRUCTIONS

DTCB (Data Combine)

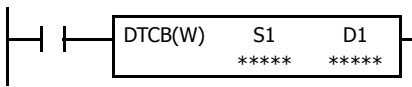

S1, S1+1 → D1

When input is on, the lower-byte data is displayed from 2 consecutive sources starting with device assigned by S1 and combined to make 16-bit data. The lower byte data from the first source device is moved to the upper byte of the destination assigned by device D1, and the lower byte data from the next source device is moved to the lower byte of the destination.

Applicable SmartAXIS

| FT1A-12 | FT1A-24 | FT1A-40 | FT1A-48 | FT1A-Touch |
|---------|---------|---------|---------|------------|
| X | X | X | X | X |

Valid Devices

| Device | Function | I | Q | M | R | T | C | D | Constant | Repeat |
|--------------------|------------------------------|---|---|---|---|---|---|---|----------|--------|
| S1 (Source 1) | Binary data to combine | — | — | — | — | — | — | X | — | — |
| D1 (Destination 1) | Destination to store results | — | X | ▲ | X | X | X | X | — | — |

For valid device address ranges, see "Device Addresses" on page 3-1.

▲ Special internal relays cannot be designated as D1.

When T (timer) or C (counter) is used as D1, the data is written in as a preset value (TP or CP) which can be 0 through 65535.

Source device S1 uses 2 data registers starting with the device assigned by S1.

Since the DTCB instruction is executed in each scan while input is on, a pulse input from a SOTU or SOTD instruction should be used.

Valid Data Types

| | | |
|------------------------|---|--|
| W (word) | X | When a bit device such as I (input), Q (output), M (internal relay), or R (shift register) is assigned as the destination, 16 points (word data) are used. |
| I (integer) | — | |
| D (double word) | — | When a word device such as T (timer), C (counter), or D (data register) is assigned as the source or destination, 1 point (word data) is used. |
| L (long) | — | |
| F (float) | — | |

Example: DTCB

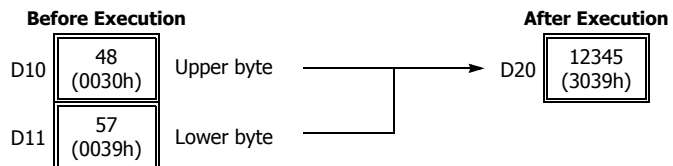

SWAP (Data Swap)

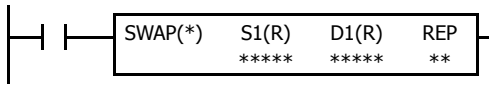

S1 → D1

When input is on, upper and lower byte- or word-data of a word- or double-word-data assigned by S1 are exchanged, and the result is stored to destination assigned by D1.

Applicable SmartAXIS

| FT1A-12 | FT1A-24 | FT1A-40 | FT1A-48 | FT1A-Touch |
|---------|---------|---------|---------|------------|
| X | X | X | X | X |

Valid Devices

| Device | Function | I | Q | M | R | T | C | D | Constant | Repeat |
|--------------------|--|---|---|---|---|---|---|---|----------|--------|
| S1 (Source 1) | Binary data to swap | — | — | — | — | — | — | X | — | 1-99 |
| D1 (Destination 1) | Destination to store conversion result | — | — | — | — | — | — | X | — | 1-99 |

For valid device address ranges, see "Device Addresses" on page 3-1.

Since the SWAP instruction is executed in each scan while input is on, a pulse input from a SOTU or SOTD instruction should be used.

Valid Data Types

| | |
|------------------------|---|
| W (word) | X |
| I (integer) | — |
| D (double word) | X |
| L (long) | — |
| F (float) | — |

When a D (data register) is assigned as the source or destination, 1 point (word data) or 2 points (double-word data) are used. When repeat is assigned, the quantity of device words increases in 1- or 2-point increments.

Examples: SWAP

• Data Type: W (word)

When input I0 is turned on, upper- and lower-byte data of the 16-bit data in data register D10 assigned by source device S1 are exchanged, and the result is stored to data register D20 assigned by destination device D1.

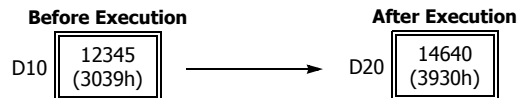
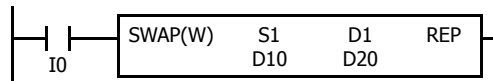

• Data Type: D (double-word)

When input I1 is turned on, upper- and lower-word data of the 32-bit data in data registers D10 and D11 assigned by source device S1 are exchanged, and the result is stored to data registers D20 and D21 assigned by destination device D1.

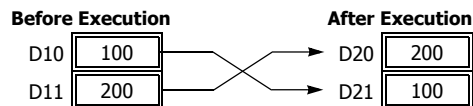
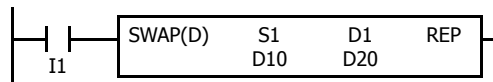

12: WEEK PROGRAMMER INSTRUCTIONS

Introduction

The Week Programmer instructions turn output on or off at a specified interval.

WEEK (Weekly Timer)

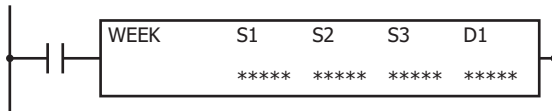

The WEEK instruction compares the specified day of the week, ON time, and OFF time with the current time and outputs that result.

When the input is on, the output specified by D1 is turned on when the day of the week and the time specified by the ON settings match the current day of the week and time.

The output is also turned off when the day of the week and the time specified by the OFF settings match the current day of the week and time.

For example, if the ON settings are Monday 13:00 and the OFF settings are Wednesday 18:00, output D1 turns on and off as follows.

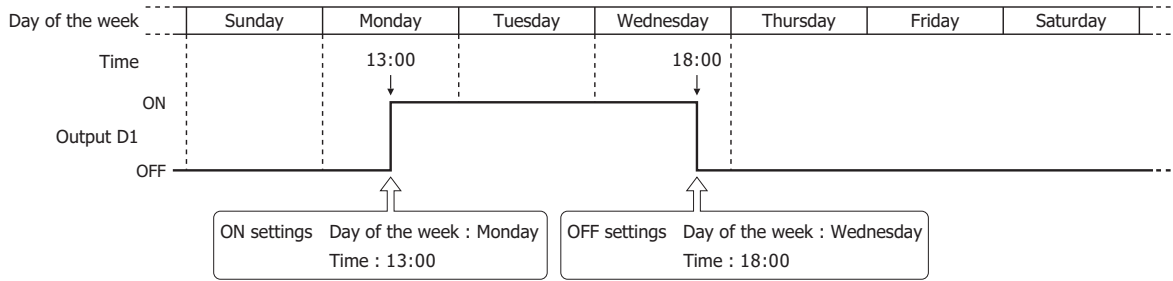

Notes:

- A maximum of 10 WEEK instructions can be used in a user program.
- Normally the output is only updated when the current time and the time for the ON/OFF settings matches, but when the WEEK instruction input changes from off to on, the output state at the current time is determined according to the ON/OFF settings and the output is turned on or off.
- When pulse output is enabled, output is turned on for one scan at the ON settings time. For pulse output, see "6. Pulse Output" on page 12-3 or "6. Pulse Output" on page 12-6.
- When the ON time is set to a value larger than 2359, the OFF time is set to a value larger than 2400, or the lower 2 digits of ON/OFF time is set to a value larger than 59, a user program execution error will occur.
- When the day of the week is not specified, a user program execution error will occur.
- The WEEK instruction cannot be used in an interrupt program. If used, a user program execution error will result, turning on special internal relay M8004 and the ERR LED on the SmartAXIS. For details about the user program execution errors, see "User Program Execution Errors" on page 4-13.

Applicable SmartAXIS

| FT1A-12 | FT1A-24 | FT1A-40 | FT1A-48 | FT1A-Touch |
|---------|---------|---------|---------|------------|
| X | X | X | X | X |

Valid Devices

| Device | Function | I | Q | M | R | T | C | D | Constant | Repeat |
|--------------------|--------------------------|---|---|---|---|---|---|---|----------|--------|
| S1 (Source 1) | Starting data register | — | — | — | — | — | — | ▲ | — | — |
| S2 (Source 2) | Initialization input | — | — | X | — | — | — | — | — | — |
| S3 (Source 3) | Number of parameter tabs | — | — | — | — | — | — | — | X | — |
| D1 (Destination 1) | Output port | — | X | ▲ | — | — | — | — | — | — |

▲ Special data registers cannot be designated as S1. Internal relays M0 through M1277 can be designated as D1. Special internal relays cannot be designated as D1.

Settings

There are two methods to configure the day of the week and the time for the WEEK instruction. Specify the method on the **Device** tab with **Data register settings**.

- Configuring the day of the week and the time as fixed settings
The day of the week and the time for the ON/OFF settings are uniquely determined. The day of the week and the time for the ON/OFF settings cannot be changed while the SmartAXIS is running. For details, see "To configure the day of the week and the time as fixed settings" on page 12-2.
- Configuring the day of the week and the time by specifying data registers
The day of the week and the time for the ON/OFF settings are configured according to the values stored in the specified data registers. The day of the week and the time for the ON/OFF settings can be changed while the SmartAXIS is running. For details, see "To configure the days of the week and the time by specifying data registers" on page 12-5.

To configure the day of the week and the time as fixed settings

The day of the week and the time for the ON/OFF settings are uniquely determined. The day of the week and the time for the ON/OFF settings cannot be changed while the SmartAXIS is running.

• Device tab

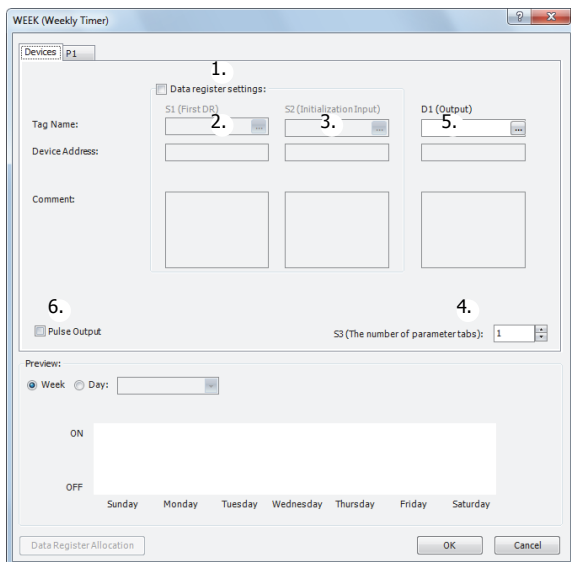

1. Data register settings

This setting determines whether to configure the day of the week and the time as fixed settings or to indirectly specify them with data registers.

To configure the day of the week and the time as fixed settings, clear this check box.

Unselected check box

The day of the week and the time are fixed settings. The day of the week and the time are configured on the parameter tabs. The day of the week and the time cannot be changed while the SmartAXIS is running. For the settings, see "Parameter tab" on page 12-3.

Note: When this check box is selected, the settings for the day of the week and the time are indirectly specified with data registers.

Configure the day of the week and the time by using data registers. The day of the week and the time can be changed while the SmartAXIS is running. For directions specific to data registers, see "To configure the days of the week and the time by specifying data registers" on page 12-5.

2. S1 (source 1): Starting data register

This setting is not configured when configuring the day of the week and the time as fixed settings.

3. S2 (source 2): Initialization input

This setting is not configured when configuring the day of the week and the time as fixed settings.

4. S3 (source 3): Number of parameter tabs

This setting configures the number of parameter tabs. When this value is increased or decreased, the number of parameter tabs displayed on the dialog box increases or decreases. 6 bytes of the user program region are used for each parameter tab. For the settings, see "Parameter tab" on page 12-3.

5. D1 (destination 1): Output

This setting configures the output for the results when the configured day of the week and time and the current day of the week and time are compared.

| Setting | Description |
|----------------|--|
| Tag Name | Specifies the tag name or the device address for each device. |
| Device Address | Shows the device address that corresponds to the tag name. |
| Comment | Shows the comment for the device address. This item can be edited. |

6. Pulse Output

This setting configures the operation for D1 (output). This setting is applied to all parameter tabs.

Selected check box

When the day of the week and the time configured in the ON settings matches the current day of the week and the time, the output is turned on for only one scan.

Unselected check box

The output is turned on and off according to the ON settings and the OFF settings.

• Parameter tab

This tab configures the ON/OFF settings for the output. A maximum of 20 parameter tabs can be configured for one WEEK instruction.

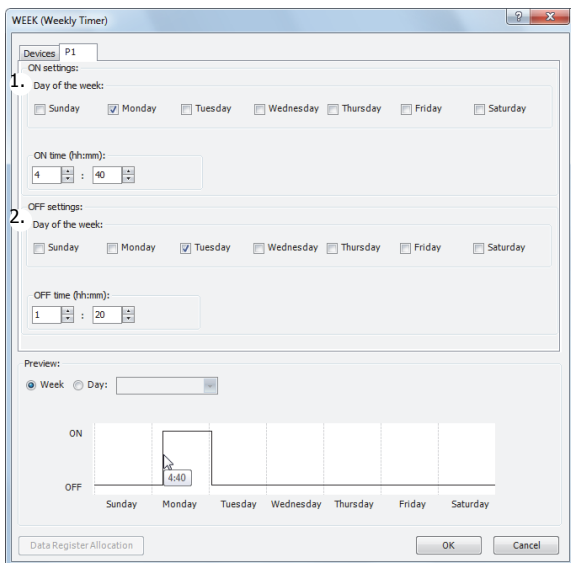

1. ON settings

This section configures the day of the week and the time to turn on the output. The output is turned on at the specified time for the specified day of the week.

| Setting | Description | Range |
|-----------------|--|----------------------------------|
| Day of the week | Specifies the days of the week. | — |
| ON time | Used to enter the time. Set the time in a range from 00:00 to 23:59. | Hour: 0 to 23 Minute: 0 to 59 |

12: WEEK PROGRAMMER INSTRUCTIONS

2. OFF settings

This section configures the day of the week and the time to turn off the output. The output is turned off at the specified time for the specified day of the week.

| Setting | Description | Range |
|-----------------|--|----------------------------------|
| Day of the week | Specifies the days of the week. | — |
| OFF time | Used to enter the time. Set the time in a range from 00:00 to 24:00. | Hour: 0 to 24 Minute: 0 to 59 |

Note: When the time is duplicated in the settings on other tabs, the settings on the tab with the larger tab number are valid.

For example, if **ON time** is 8:00 and **OFF time** is 9:00 on the **P 1** tab and **ON time** is 9:00 and **OFF time** is 10:00 on the **P 2** tab, the 9:00 setting is duplicated on the two tabs and **OFF time** for the **P 1** tab is disabled. In this situation, the output is on from 8:00 to 10:00.

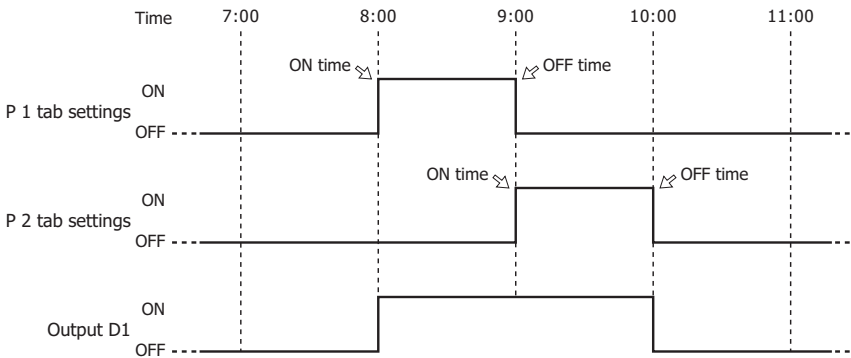

If **ON time** is 9:00 and **OFF time** is 10:00 on the **P 1** tab and **ON time** is 8:00 and **OFF time** is 9:00 on the **P 2** tab, the 9:00 setting is duplicated on the two tabs and **ON time** for the **P 1** tab is disabled. In this situation, the output is on from 8:00 to 9:00.

• Preview

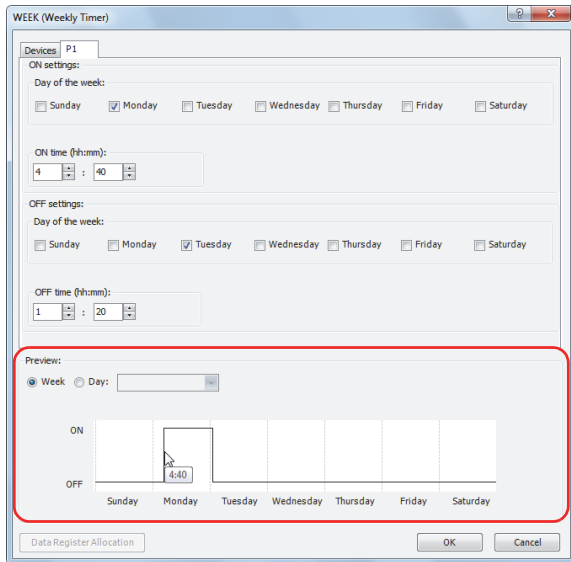

The preview shows the ON/OFF state for the output based on the settings configured on the parameter tabs as a time chart. The preview can be shown as a week or a day.

| Setting | Description |
|---------|--|
| Week | Select this radio button when showing the preview as a week. |
| Day | Select this radio button when showing the preview as a day. |

To configure the days of the week and the time by specifying data registers

The day of the week and the time for the ON/OFF settings are configured according to the values stored in the specified data registers. The day of the week and the time for the ON/OFF settings can be changed while the SmartAXIS is running.

When the day of the week or time in the ON/OFF settings is modified with the WEEK instruction input turned on, the modified data register values are reflected in the ladder program when the current date and time matches the day of the week or time in the ON/OFF settings.

• **Device tab**

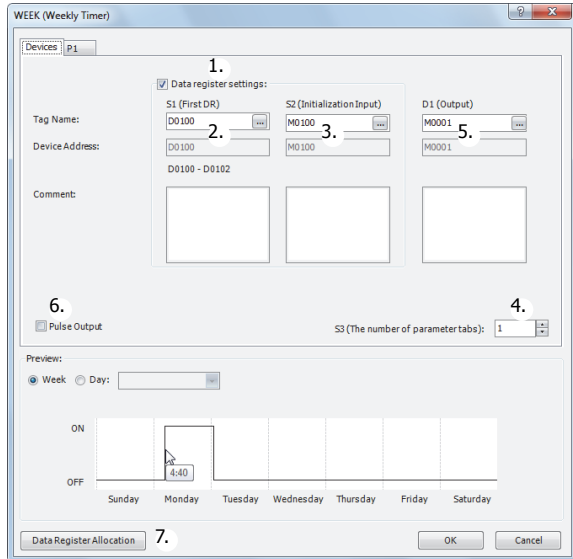

1. Data register settings

This setting selects whether to configure the day of the week and the time as fixed settings or to indirectly specify them with data registers. To configure the day of the week and the time by specifying data registers, select this check box.

Selected check box

The day of the week and the time settings are indirectly specified by data registers. Configure the day of the week and the time by using data registers. The day of the week and the time can be changed while the SmartAXIS is running. For allocating the data register region, see "Data Register Allocation" on page 12-7.

The data registers can be initialized with the days of the week and the times configured on the parameter tabs by turning on the initialization input. For initialization, see "3. S2 (source 2): Initialization input" on page 12-6.

Note: When this check box is not selected, the day of the week and the time are fixed settings. The day of the week and the time are configured on the parameter tabs. The day of the week and the time cannot be changed while the SmartAXIS is running. For fixed settings, see "To configure the day of the week and the time as fixed settings" on page 12-2.

2. S1 (source 1): Starting data register

This setting specifies the start of the data register region to store the days of the week and time settings for the WEEK instruction.

This setting is only used when indirectly specifying the settings for the WEEK instruction with data registers.

| Setting | Description |
|---------------------|--|
| Tag Name | Specifies the tag name or the device address for the device. |
| Device Address | Shows the device address that corresponds to the tag name. |
| Used Data Registers | Shows the range of data registers used to store the settings. This item changes when the device address or the number of parameter tabs changes. |
| Comment | Shows the comment for the device address. This item can be edited. |

For allocating the data register region, see "Parameter tab" on page 12-6.

12: WEEK PROGRAMMER INSTRUCTIONS

3. S2 (source 2): Initialization input

This setting specifies the device to initialize the days of the week and the times stored in the data register region that starts from S1 (source 1).

The values configured on the parameter tabs are stored in the data registers by turning on the initialization input.

This setting is only used when indirectly specifying the settings for the WEEK instruction with data registers.

4. S3 (source 3): Number of parameter tabs

This setting configures the number of parameter tabs.

This setting is shared in common with "To configure the day of the week and the time as fixed settings". See "4. S3 (source 3): Number of parameter tabs" on page 12-3.

5. D1 (destination 1): Output

This setting configures the output for the results when the configured day of the week and time and the current day of the week and time are compared.

This setting is shared in common with "To configure the day of the week and the time as fixed settings". See "5. D1 (destination 1): Output" on page 12-3.

6. Pulse Output

This setting configures the operation for D1 (output). This setting is applied to all parameter tabs and is shared in common with "To configure the day of the week and the time as fixed settings". See "6. Pulse Output" on page 12-3.

7. Data Register Allocation

Click this button to display the Data Register Allocation dialog box. As shown below, a table showing the data registers and their corresponding WEEK instruction settings is displayed on the dialog box (8). Click **Allocate Comments** (9) and you can configure the comments for the data registers that correspond to the names of the settings.

This button is only used when indirectly specifying the settings for the WEEK instruction with data registers.

• Data Register Allocation dialog box

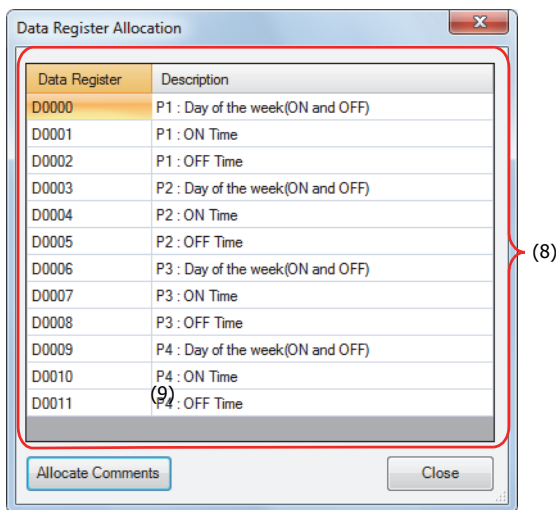

• Parameter tab

This tab configures the ON/OFF settings for the output. A maximum of 20 parameter tabs can be configured for 1 WEEK instruction.

If indirectly specifying the settings for the WEEK instruction with data registers, the settings configured on the parameter tabs are stored in the data registers when the initialization input is turned on.

This setting is shared in common with "To configure the day of the week and the time as fixed settings". See "Parameter tab" on page 12-3.

• Preview

The preview shows the ON/OFF state for the output based on the settings configured on the parameter tabs as a time chart.

This function is shared in common with "To configure the day of the week and the time as fixed settings". See "Preview" on page 12-4.

Data Register Allocation

If indirectly specifying the settings for the WEEK instruction with data registers, the settings are allocated to the data registers as follows.

| Storage destination | Data size (word) | R (Read)/W (Write) | Setting | |
|---------------------|------------------|--------------------|----------|-----------------|
| Start address+0 | 1 | R/W | P 1 tab | Day of the week |
| Start address+1 | 1 | R/W | | ON time |
| Start address+2 | 1 | R/W | | OFF time |
| Start address+3 | 1 | R/W | P 2 tab | Day of the week |
| Start address+4 | 1 | R/W | | ON time |
| Start address+5 | 1 | R/W | | OFF time |
| • | • | • | | • |
| • | • | • | | • |
| • | • | • | | • |
| Start address+57 | 1 | R/W | P 20 tab | Day of the week |
| Start address+58 | 1 | R/W | | ON time |
| Start address+59 | 1 | R/W | | OFF time |

• **Day of the week data register allocation**

The day of the week for the ON settings and the day of the week for the OFF settings are allocated as bits in 1 data register as follows.

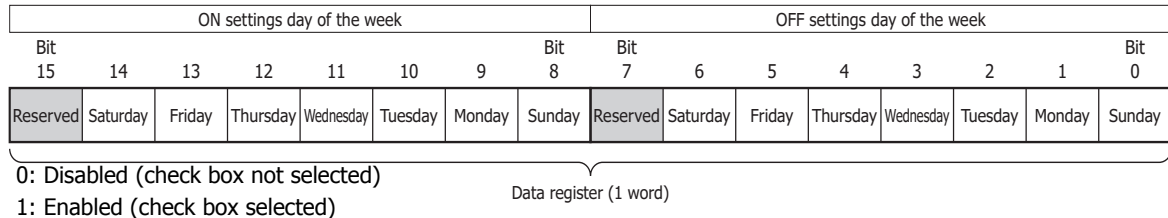

Example day of the week settings

[To configure the output to turn on Monday and to turn off Friday]

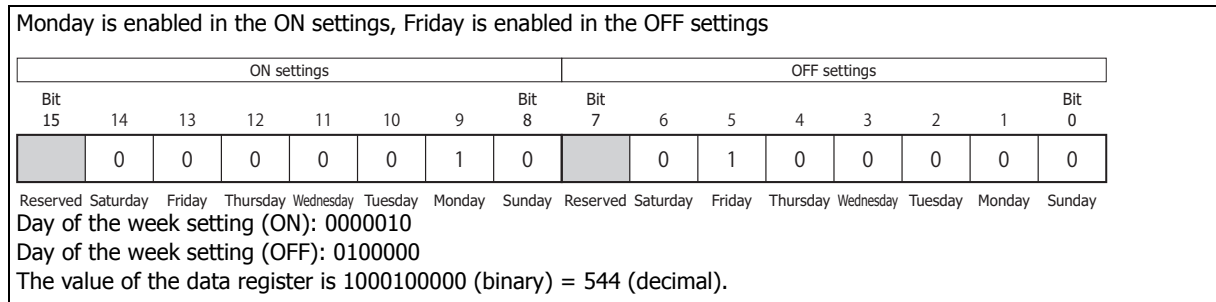

[To configure the output to turn on Monday and Thursday and to turn off Tuesday and Saturday]

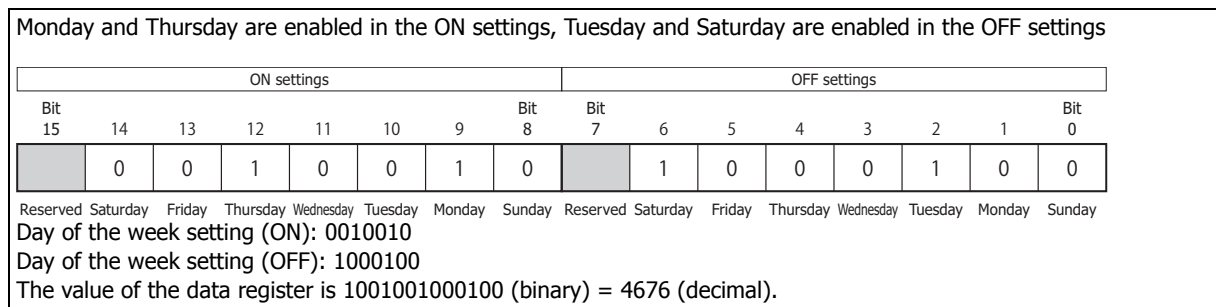

The ON time and the OFF time are stored in the data register as follows.



12: WEEK PROGRAMMER INSTRUCTIONS

Examples: WEEK

[To turn on output Q0 Monday to Friday each week from 8:30 to 17:15]

Parameter tab

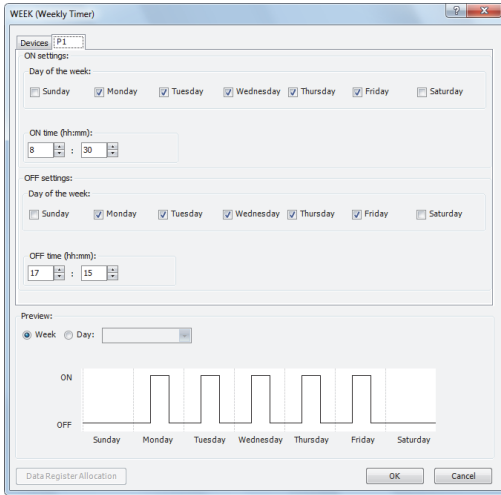

Configure the tab as shown above and set **D1** to Q0.

Ladder program

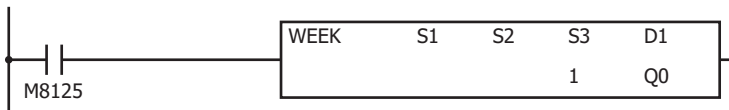

[To turn on output Q0 Tuesday, Wednesday, and Saturday each week from 20:30 to 1:15 the next day]

Parameter tab

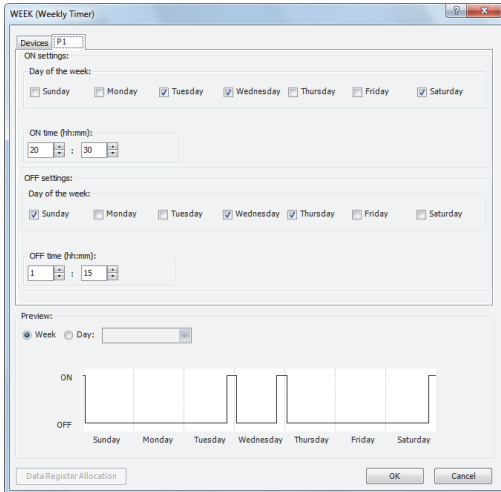

Configure the tab as shown above and set **D1** to Q0.

Ladder program

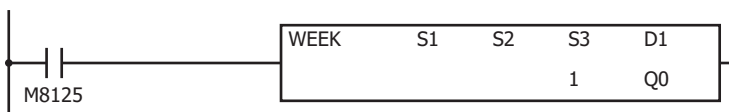

[To turn on output Q0 Monday, Wednesday, and Friday each week from 6:00 to 9:00, 15:00 to 18:00, and 22:00 to 0:00 the next day]

Parameter tab

Configure the settings using three tabs.

On P 1 tab, configure the output to turn on Monday, Wednesday, and Friday from 6:00 to 9:00.

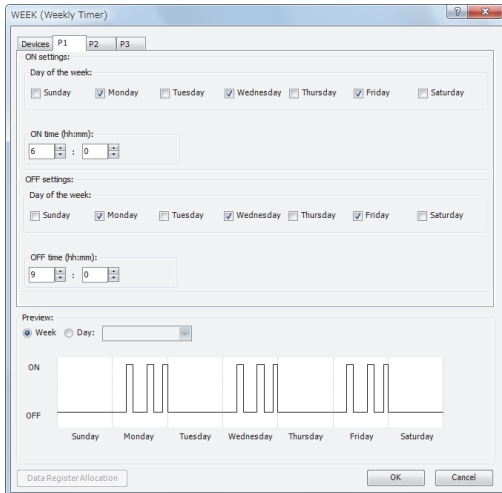

On P 2 tab, configure the output to turn on Monday, Wednesday, and Friday from 15:00 to 18:00.

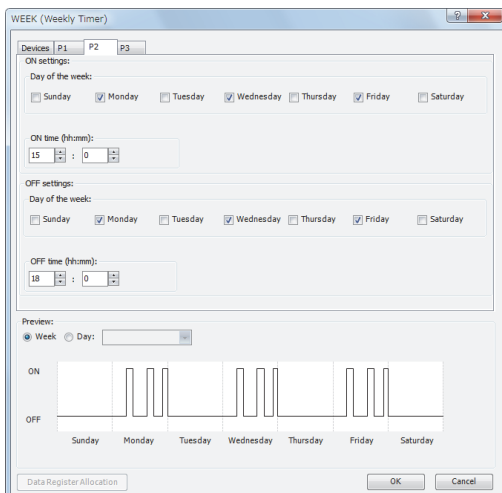

On P 3 tab, configure the output to turn on Monday, Wednesday, and Friday from 22:00 to 0:00 the next day.

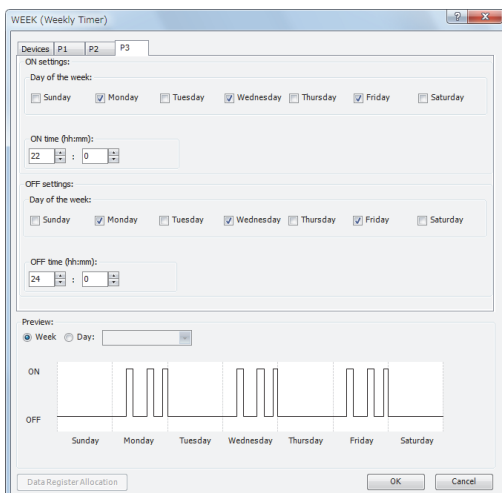

Configure the tabs as shown above and set **D1** to Q0.

12: WEEK PROGRAMMER INSTRUCTIONS

Ladder program

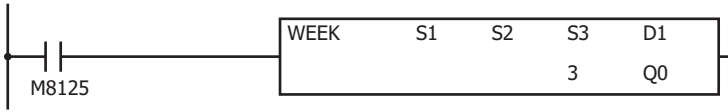

[To indirectly specify the settings with data registers]

This example describes turning on output M100 Monday to Friday each week from 8:30 to 17:15 as an example. Select the **Data register settings** check box and set S1 to D0 and S2 to M0.

Parameter tab

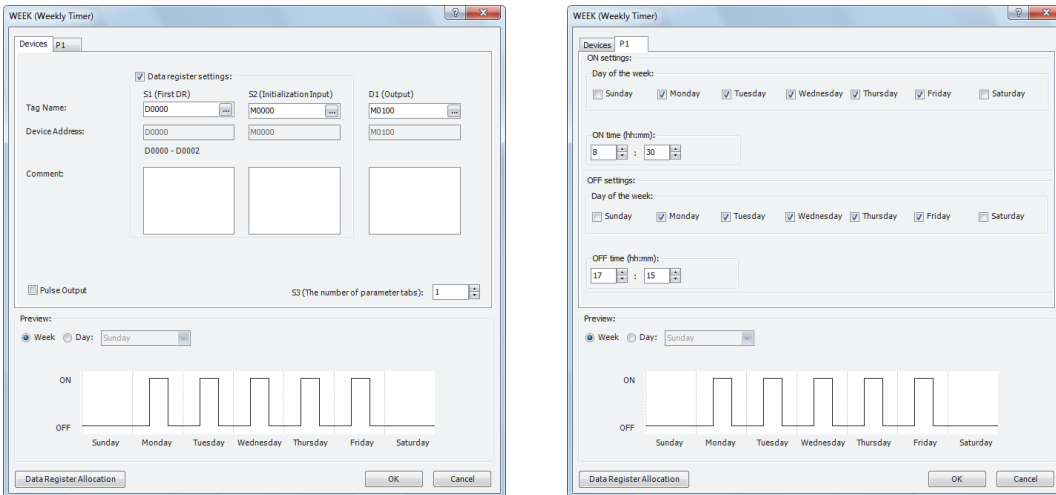

Data register allocation

The settings on the **P 1** tab are allocated to data registers D0 to D2 as shown in the table below. The settings configured on the parameter tab are stored in D0 to D2 by turning on initialization input S2.

| Data register | Setting | Initial setting |
|---------------|---------|---|
| D0 | P 1 tab | Day of the week setting |
| D1 | | ON time |
| D2 | | OFF time |
| | | 15934 (Monday to Friday, both ON settings and OFF settings) |
| | | 830 |
| | | 1715 |

Ladder program

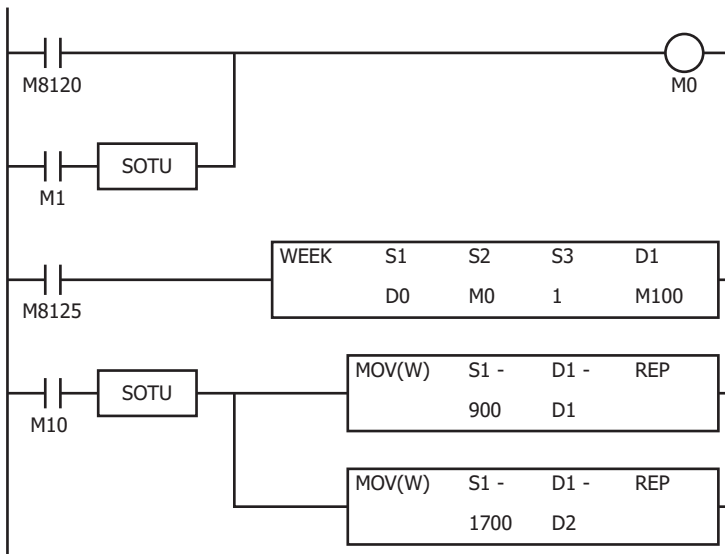

- The initialization input (M1) turns on with the first scan and the initial settings configured on the **P 1** tab are stored in D0 to D2.
- The WEEK instruction starts operating according to the values of data registers D0 to D2.
- When M10 turns on, the ON time (D1) changes to 9:00 and the OFF time (D2) changes to 17:00.
- When M1 turns on, all of the WEEK instruction settings (D0 to D2) return to the initial settings.

YEAR (Yearly Timer)

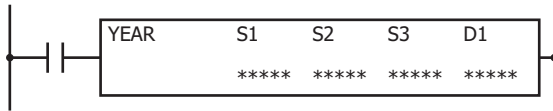

The YEAR instruction compares the specified date with the current date and outputs that result. With this instruction you can specify special dates within a one year period.

When the input is on, the output specified by D1 is turned on when the date specified by the ON settings matches the current date.

The output is turned off when the date specified by the OFF settings matches the current date.

When the ON settings are December 15, 2012 and the OFF settings are January 20, 2013, output D1 turns on and off as follows.

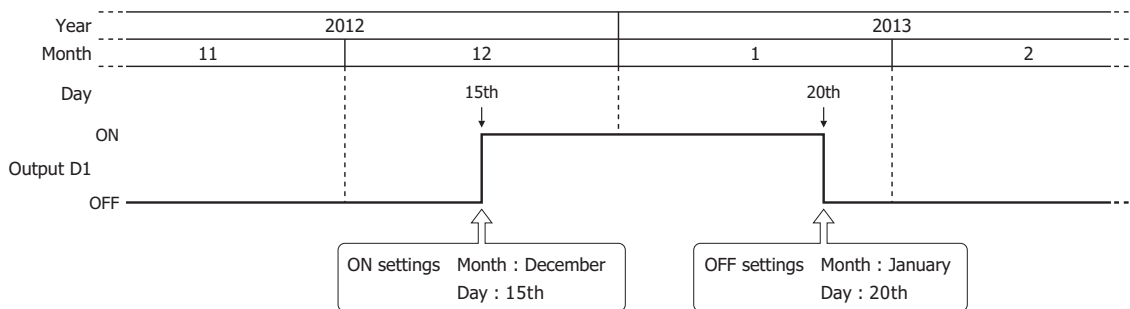

Notes:

- A maximum of 10 YEAR instructions can be used in a user program.
- Normally the output is only updated when the current date and the date for the ON/OFF settings matches, but when the YEAR instruction input changes from off to on, the output state at the current date is determined according to the ON/OFF settings and the output is turned on or off.
For details, see "Timing Chart when the Input Turns On during the Configured Interval" on page 12-21.
- When pulse output is enabled, output is turned on for one scan at the instant (0:00) the date changes to the ON date.
When the YEAR instruction input changes from off to on, the output state at the current date is judged according to the ON/OFF settings, and the output is turned on for 1 scan only.
For pulse output, see "6. Pulse Output" on page 12-13 or "6. Pulse Output" on page 12-17.
- When the year data is outside the range of 2000 to 2099, the month data is outside the range of 1 to 12, the day data is outside the range of 1 to 31, the week data is outside the range of 1 to 5, and the day of the week data is outside the range of 0 to 6, a user program execution error will occur.
- The YEAR instruction cannot be used in an interrupt program.
If used, a user program execution error will result, turning on special internal relay M8004 and the ERR LED on the SmartAXIS. For details about the user program execution errors, see "User Program Execution Errors" on page 4-13.
- When the yearly setting or monthly setting is enabled and a date that does not exist according to the month or year is set for the ON setting or the OFF setting, the output turns on or off on the first day of the next month.

Applicable SmartAXIS

| FT1A-12 | FT1A-24 | FT1A-40 | FT1A-48 | FT1A-Touch |
|---------|---------|---------|---------|------------|
| X | X | X | X | X |

Valid Devices

| Device | Function | I | Q | M | R | T | C | D | Constant | Repeat |
|--------------------|--------------------------|---|---|---|---|---|---|---|----------|--------|
| S1 (Source 1) | Starting data register | — | — | — | — | — | — | ▲ | — | — |
| S2 (Source 2) | Initialization input | — | — | X | — | — | — | — | — | — |
| S3 (Source 3) | Number of parameter tabs | — | — | — | — | — | — | — | X | — |
| D1 (Destination 1) | Output port | — | X | ▲ | — | — | — | — | — | — |

▲ Special data registers cannot be designated as S1. Internal relays M0 through M1277 can be designated as D1. Special internal relays cannot be designated as D1.

Settings

There are two methods to configure dates for the YEAR instruction. Specify the method on the **Device** tab with **Data register settings**.

- Configure the dates as a fixed setting

The dates for the ON/OFF settings are uniquely determined. The dates for the ON/OFF settings cannot be changed while the SmartAXIS is running. For details, see "To configure the dates as a fixed setting" on page 12-12.

- Configuring the dates by specifying data registers

The dates for the ON/OFF settings are configured according to the values stored in the specified data registers. The dates for the ON/OFF settings can be changed while the SmartAXIS is running. For details, see "To configure the dates by specifying data registers" on page 12-16.

To configure the dates as a fixed setting

The dates for the ON/OFF settings are uniquely determined. The dates for the ON/OFF settings cannot be changed while the SmartAXIS is running.

• Device tab

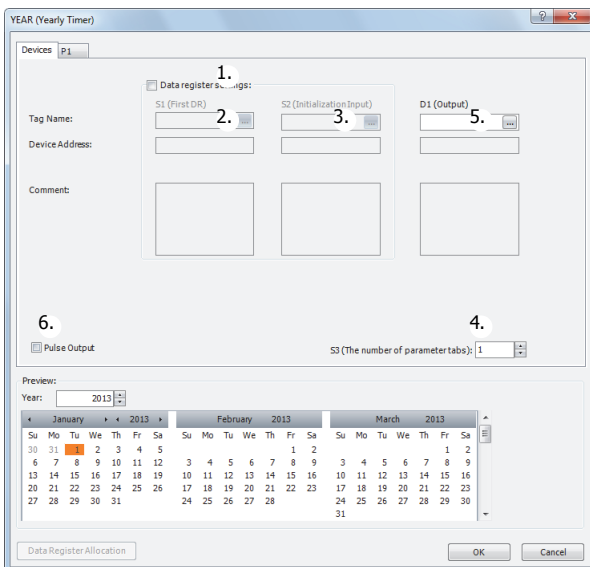

1. Data register settings

This setting selects whether to configure YEAR instruction dates as fixed settings or to indirectly specify them with data registers.

To configure the dates as fixed settings, clear this check box.

Unselected check box

The dates are fixed settings.

The dates are configured on the parameter tabs. The dates cannot be changed while the SmartAXIS is running. For the settings, see "Parameter tab" on page 12-3.

Note: When this check box is selected, the settings for dates are indirectly specified with data registers. Configure the dates by using data registers. The dates can be changed while the SmartAXIS is running. For indirection specification with data registers, see "To configure the dates by specifying data registers" on page 12-16.

2. S1 (source 1): Starting data register

This setting is not configured when configuring the dates as fixed settings.

3. S2 (source 2): Initialization input

This setting is not configured when configuring the dates as fixed settings.

4. S3 (source 3): Number of parameter tabs

This setting configures the number of parameter tabs. When this value is increased or decreased, the number of parameter tabs displayed on the dialog box increases or decreases. 10 bytes of the user program region are used for each parameter tab. For the settings, see "Parameter tab" on page 12-13.

5. D1 (destination 1): Output

This setting configures the output for the results when the configured dates and the current date are compared.

| Setting | Description |
|----------------|--|
| Tag Name | Specifies the tag name or the device address for each device. |
| Device Address | Shows the device address that corresponds to the tag name. |
| Comment | Shows the comment for the device address. This item can be edited. |

6. Pulse Output

This setting configures the operation for D1 (output). This setting is applied to all parameter tabs.

Selected check box

When the current date changes to the date in the ON settings, the output is turned on for only one scan.

Unselected check box

The output is turned on and off according to the ON settings and the OFF settings.

• Parameter tab

This tab configures the settings for the output. A maximum of 20 parameter tabs can be configured for 1 YEAR instruction.

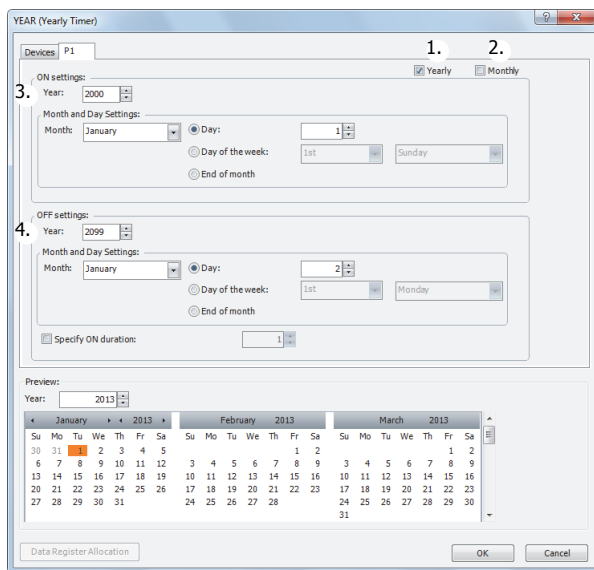

1. Yearly

When **Yearly** is selected, the **Month and Day settings** are valid every year.

At this time, you can configure whether or not to make the **Month and Day settings** valid yearly from a year until another year with **Year**.

2. Monthly

The settings for the selected tab are valid each month. At this time, **Month** is disabled.

12: WEEK PROGRAMMER INSTRUCTIONS

3. ON settings

This section configures the date to turn on the output. The output is turned on at 0:00 on the configured date.

| Setting | | Description | Range |
|-----------------------|-----------------|---|--------------|
| Year | | Specifies the year to turn on the output. | 2000 to 2099 |
| Month and Day Setting | Month | Specifies the month to turn on the output. | 1 to 12 |
| | Day | Specifies the day to turn on the output. | 1 to 31 |
| | Day of the week | Specifies the day as the day of the week to turn on the output. Specify the week in the range of the 1st to the 5th (or the last) week and set the day of the week. | 1 to 6 |
| | End of month | Specify the end of month to turn on the output on the last day of the month. | — |

4. OFF settings

This section configures the date to turn off the output. The output is turned off at 0:00 on the configured date.

| Setting | | Description | Range |
|-----------------------|-----------------|--|--------------|
| Year | | Specifies the year to turn off the output. | 2000 to 2099 |
| Month and Day Setting | Month | Specifies the month to turn off the output. | 1 to 12 |
| | Day | Specifies the day to turn off the output. | 1 to 31 |
| | Day of the week | Specifies the day as the day of the week to turn on the output. Specify the week in the range of the 1st to the 5th (or the last) week and set the day of the week. | 1 to 6 |
| | End of month | Specify the end of month to turn off the output on the last day of the month. | — |
| Specify ON duration | | This item specifies whether or not to turn off the output after the number of specified days from when it was turned on. If this setting is enabled, the OFF settings are disabled. This setting can be set in a range from 1 day to 30 days. | 1 to 30 |

Note: When the date is duplicated in the settings on other tabs, the settings on the tab with the larger tab number are valid.

For example, if the ON date is the 8th of every month and the OFF date is the 16th of every month on the **P 1** tab and the ON date is the 16th of every month and the OFF date is the 22nd of every month on the **P 2** tab, the 16th of every month setting is duplicated on the two tabs and the ON settings for the **P 2** tab are valid. In this situation, the output is on from the 8th to the 22nd of every month.

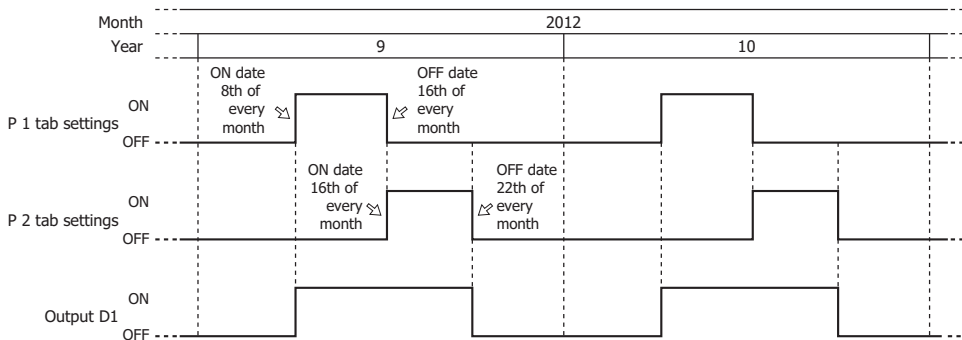

If the ON date is the 16th of every month and the OFF date is the 22nd of every month on the **P 1** tab and the ON date is the 8th of every month and the OFF date is the 16th of every month on the **P 2** tab, the 16th of every month setting is duplicated on the two tabs and the ON settings for the **P 1** tab are disabled. In this situation, the output is on from the 8th to the 16th of every month.

• Preview

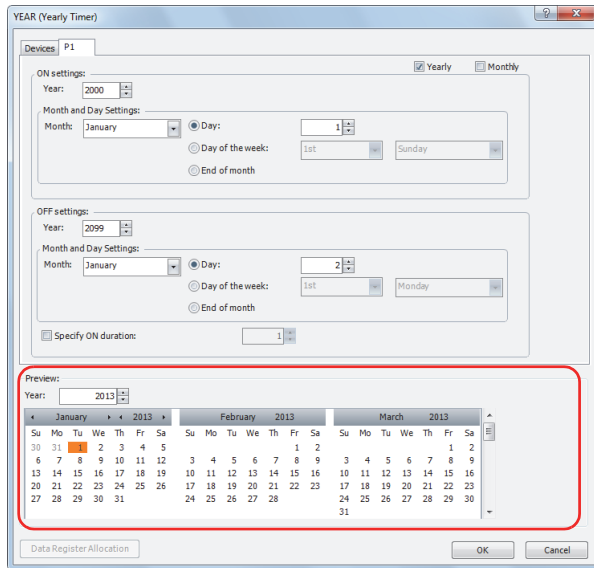

The preview shows the ON/OFF state for the output based on the settings configured on the parameter tabs in a calendar. The dates that are set to ON are highlighted in orange. Three months are shown at one time.

| Setting | Description |
|-----------|--|
| Year | Specifies the year to show in the preview. |
| Scrollbar | You can change the month shown in the preview by moving the scrollbar. |

To configure the dates by specifying data registers

The dates for the ON/OFF settings are configured according to the values stored in the specified data registers.

The dates for the ON/OFF settings can be changed while the SmartAXIS is running.

When the date in the ON/OFF settings is modified with the YEAR instruction input turned on, the modified data register values are reflected in the ladder program when the current date and time matches 0:00 on the date in the ON/OFF settings.

• **Device tab**

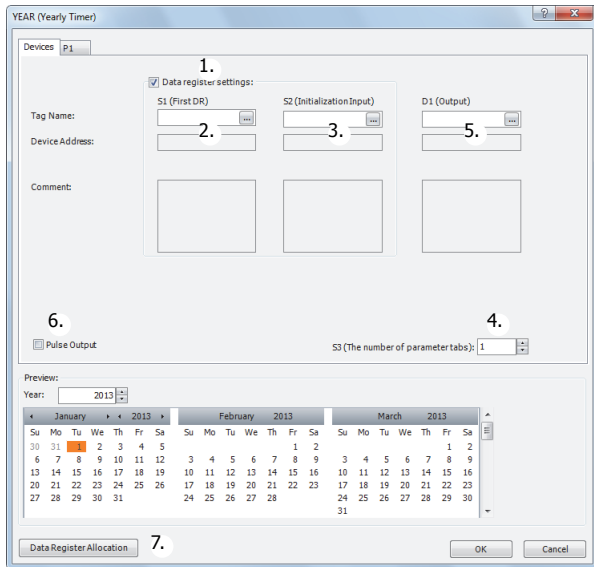

1. Data register settings

This setting selects whether to configure YEAR instruction dates as fixed settings or to indirectly specify them with data registers.

To configure the dates by specifying data registers, select this check box.

Selected check box

The date settings are indirectly specified by data registers. Configure the dates by using data registers. The dates can be changed while the SmartAXIS is running. For allocating the data register region, see "Data Register Allocation" on page 12-18.

The data registers can be initialized with the days of the week and the times configured on the parameter tabs by turning on the initialization input. For initialization, see "3. S2 (source 2): Initialization input" on page 12-16.

Note: When this check box is not selected, the dates are fixed settings. The dates are configured on the parameter tabs. The dates cannot be changed while the SmartAXIS is running. For fixed settings, see "To configure the dates as a fixed setting" on page 12-12.

2. S1 (source 1): Starting data register

This setting specifies the start of the data register region to store the dates for the YEAR instruction.

This setting is only used when indirectly specifying the dates with data registers.

| Setting | Description |
|---------------------|--|
| Tag Name | Specifies the tag name or the device address for the device. |
| Device Address | Shows the device address that corresponds to the tag name. |
| Used Data Registers | Shows the range of data registers used to store the settings. This item changes when the device address or the number of parameter tabs changes. |
| Comment | Shows the comment for the device address. This item can be edited. |

For allocating the data register region, see "Data Register Allocation" on page 12-18.

3. S2 (source 2): Initialization input

This setting specifies the device to initialize the dates stored in the data register region that starts from S1 (source 1).

The values configured on the parameter tabs are stored in the data registers by turning on the initialization input.

This setting is only used when indirectly specifying the settings for the YEAR instruction with data registers.

4. S3 (source 3): Number of parameter tabs

This setting configures the number of parameter tabs.

This setting is shared in common with "To configure the dates as a fixed setting". See "4. S3 (source 3): Number of parameter tabs" on page 12-13.

5. D1 (destination 1): Output

This setting configures the output for the results when the configured dates and the current date are compared.

This setting is shared in common with "To configure the dates as a fixed setting". See "5. D1 (destination 1): Output" on page 12-13.

6. Pulse Output

This setting configures the operation for D1 (output). This setting is applied to all parameter tabs.

This setting is shared in common with "To configure the dates as a fixed setting". See "6. Pulse Output" on page 12-13.

7. Data Register Allocation

Click this button to display the Data Register Allocation dialog box. As shown below, a table of the data registers and their corresponding YEAR instruction settings is displayed on the dialog box (8). Click **Allocate Comments** (9) and you can configure the comments for the data registers that correspond to the names of the settings.

This button is only used when indirectly specifying the settings for the YEAR instruction with data registers.

• **Data Register Allocation dialog box**

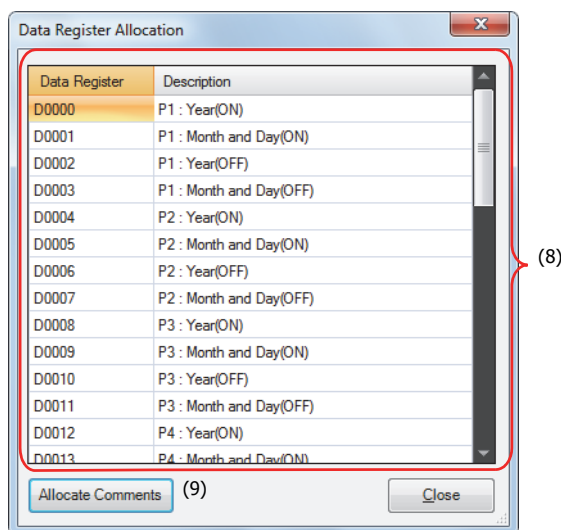

• **Parameter tab**

This tab configures the settings for the output. A maximum of 20 parameter tabs can be configured for 1 YEAR instruction.

If indirectly specifying the settings for the YEAR instruction with data registers, the settings configured on the parameter tabs are stored in the data registers when the initialization input is turned on.

This setting is shared in common with "To configure the dates as a fixed setting". See "Parameter tab" on page 12-13.

• **Preview**

The preview shows the ON/OFF state for the output based on the settings configured on the parameter tabs in a calendar.

This function is shared in common with "To configure the dates as a fixed setting". See "Preview" on page 12-15.

12: WEEK PROGRAMMER INSTRUCTIONS

Data Register Allocation

The settings configured on the parameter tabs are allocated to the data registers as follows.

| Storage destination | Data size (word) | R (Read)/ W (Write) | Setting | | |
|---------------------|------------------|------------------------|----------|-------------|--|
| Start address+0 | 1 | R/W | P 1 tab | ON setting | Year |
| Start address+1 | 1 | R/W | | | Month, Day or Day of the week |
| Start address+2 | 1 | R/W | | OFF setting | Year |
| Start address+3 | 1 | R/W | | | Month, Day or Day of the week (number of days when specified to remain on) |
| Start address+4 | 1 | R/W | P 2 tab | ON setting | Year |
| Start address+5 | 1 | R/W | | | Month, Day or Day of the week |
| Start address+6 | 1 | R/W | | OFF setting | Year |
| Start address+7 | 1 | R/W | | | Month, Day or Day of the week (number of days when specified to remain on) |
| • | • | • | | | • |
| • | • | • | | | • |
| • | • | • | | | • |
| Start address+76 | 1 | R/W | P 20 tab | ON setting | Year |
| Start address+77 | 1 | R/W | | | Month, Day or Day of the week |
| Start address+78 | 1 | R/W | | OFF setting | Year |
| Start address+79 | 1 | R/W | | | Month, Day or Day of the week (number of days when specified to remain on) |

• Month, Day or Day of the week data register allocation

The Month, Day or Day of the week are allocated as bits in 1 data register as follows.

• Month, Day

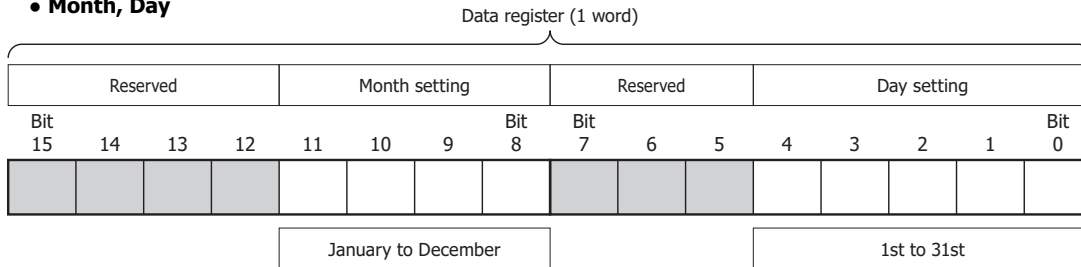

• Month, Week, Day of the week

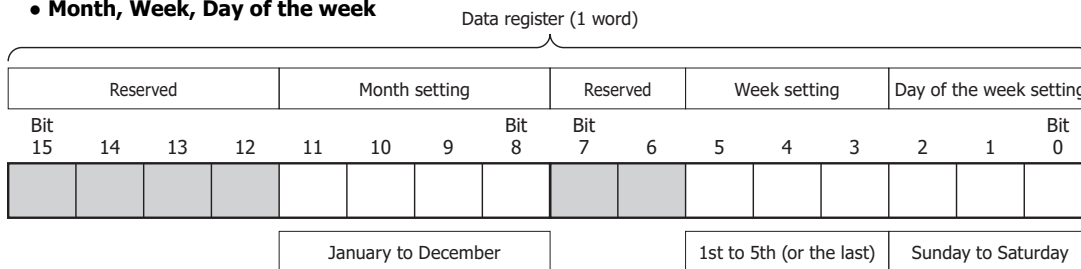

Week setting assignments Day of the week assignments

| (Binary) | (Decimal) | (Binary) | (Decimal) |
|----------|-------------|----------|-----------------|
| 001000 | = 8 : 1st | 000 | = 0 : Sunday |
| 010000 | = 16 : 2nd | 001 | = 1 : Monday |
| 011000 | = 24 : 3rd | 010 | = 2 : Tuesday |
| 100000 | = 32 : 4th | 011 | = 3 : Wednesday |
| 101000 | = 40 : 5th | 100 | = 4 : Thursday |
| 110000 | = 48 : Last | 101 | = 5 : Friday |
| | | 110 | = 6 : Saturday |

• **Month, End of month**

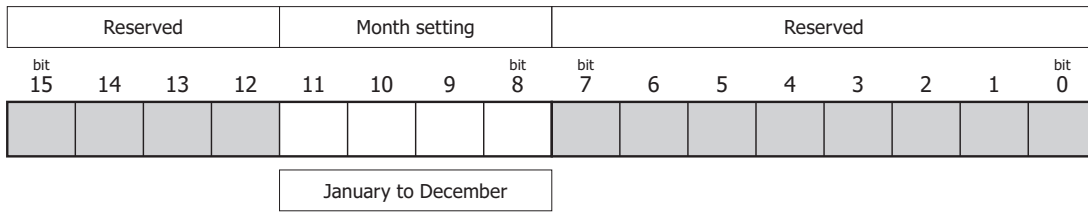

12: WEEK PROGRAMMER INSTRUCTIONS

Example day of the week settings

[When configured to turn on the output on January 1st]

| January 1st | | | | | | | | | | | | | | | |
|-------------|----|----|----|---------------|----|---|-------|----------|---|---|---|-------------|---|---|-------|
| Reserved | | | | Month setting | | | | Reserved | | | | Day setting | | | |
| Bit 15 | 14 | 13 | 12 | 11 | 10 | 9 | Bit 8 | Bit 7 | 6 | 5 | 4 | 3 | 2 | 1 | Bit 0 |
| 0 | 0 | 0 | 0 | 0 | 0 | 0 | 1 | 0 | 0 | 0 | 0 | 0 | 0 | 0 | 1 |

Month setting: 0001 = 1
 Day setting: 00001 = 1
 The value of the data register is 100000001 (binary) = 257 (decimal).

[When configured to turn on the output on December 31st]

| December 31st | | | | | | | | | | | | | | | |
|---------------|----|----|----|---------------|----|---|-------|----------|---|---|---|-------------|---|---|-------|
| Reserved | | | | Month setting | | | | Reserved | | | | Day setting | | | |
| Bit 15 | 14 | 13 | 12 | 11 | 10 | 9 | Bit 8 | Bit 7 | 6 | 5 | 4 | 3 | 2 | 1 | Bit 0 |
| 0 | 0 | 0 | 0 | 1 | 1 | 0 | 0 | 0 | 0 | 0 | 1 | 1 | 1 | 1 | 1 |

Month setting: 1100 = 12
 Day setting: 11111 = 31
 The value of the data register is 110000011111 (binary) = 3103 (decimal).

[When configured to turn on the output on the 1st Monday of January]

| 1st Monday of January | | | | | | | | | | | | | | | |
|-----------------------|----|----|----|---------------|----|---|-------|----------|---|--------------|---|---|-------------------------|---|-------|
| Reserved | | | | Month setting | | | | Reserved | | Week setting | | | Day of the week setting | | |
| Bit 15 | 14 | 13 | 12 | 11 | 10 | 9 | Bit 8 | Bit 7 | 6 | 5 | 4 | 3 | 2 | 1 | Bit 0 |
| 0 | 0 | 0 | 0 | 0 | 0 | 0 | 1 | 0 | 0 | 0 | 0 | 1 | 0 | 0 | 1 |

Month setting: 0001 = 1 (January)
 Week setting: 001 = 1 (1st)
 Day of the week setting: 001 = 1 (Monday)
 The value of the data register is 100001001 (binary) = 265 (decimal).

[When configured to turn on the output on the 4th Thursday of June]

| 4th Thursday of June | | | | | | | | | | | | | | | |
|----------------------|----|----|----|---------------|----|---|-------|----------|---|--------------|---|---|-------------------------|---|-------|
| Reserved | | | | Month setting | | | | Reserved | | Week setting | | | Day of the week setting | | |
| Bit 15 | 14 | 13 | 12 | 11 | 10 | 9 | Bit 8 | Bit 7 | 6 | 5 | 4 | 3 | 2 | 1 | Bit 0 |
| 0 | 0 | 0 | 0 | 0 | 1 | 1 | 0 | 0 | 0 | 1 | 0 | 0 | 1 | 0 | 0 |

Month setting: 0110 = 6 (June)
 Week setting: 100 = 4 (4th)
 Day of the week setting: 100 = 4 (Thursday)
 The value of the data register is 11000100100 (binary) = 1572 (decimal).

[When configured to turn on the output on the Final]

| Final | | | | | | | | | | | | | | | |
|----------|----|----|----|---------------|----|---|-------|----------|---|--------------|---|---|-------------------------|---|-------|
| Reserved | | | | Month setting | | | | Reserved | | Week setting | | | Day of the week setting | | |
| Bit 15 | 14 | 13 | 12 | 11 | 10 | 9 | Bit 8 | Bit 7 | 6 | 5 | 4 | 3 | 2 | 1 | Bit 0 |
| 0 | 0 | 0 | 0 | 0 | 1 | 1 | 0 | 0 | 1 | 1 | 0 | 0 | 1 | 0 | 0 |

Month setting: 0110 = 6 (June)
 Week setting: 110 = 6 (final)
 Day of the week setting: 100 = 4 (Thursday)
 The value of the data register is 11000110100 (binary) = 1588 (decimal).

Timing Chart when the Input Turns On during the Configured Interval

When the input turns on or off during the interval between the ON settings and the OFF settings, and when the input turns on or off after 0:00 on the date configured by the ON settings when pulse output is enabled, the timing chart is as follows.

• **When pulse output is disabled**

When the input is turned on, the current date and the ON and OFF settings are compared and the output turns on or off.

| Settings | |
|--------------|-------------------|
| ON settings | February 15, 2012 |
| OFF settings | February 17, 2012 |
| Output port | Q0 |

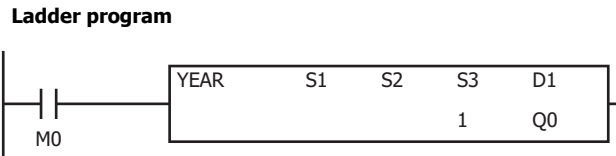

[When the input is on before the day specified by the ON settings]

On February 13, 2012, when the input is turned on, the result of the current date compared with the ON and OFF settings is not within the ON and OFF settings (February 15 to February 17, 2012). Therefore, the output remains off.

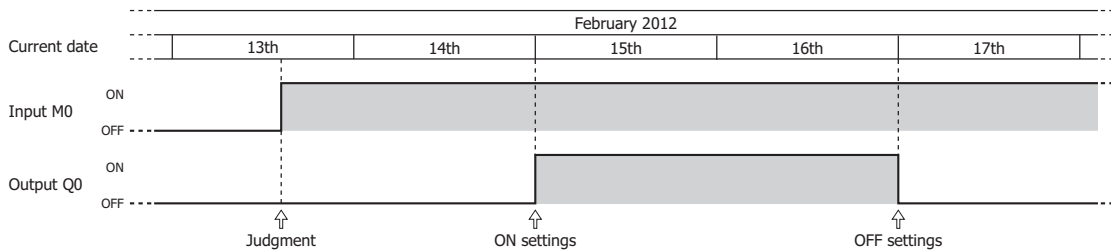

[When the input is turned on or off during the interval between the ON and OFF settings]

On February 15, 2012, when the input is turned on, the result of the current date compared with the ON and OFF settings is within the ON and OFF settings (February 15 to February 17, 2012). Therefore, the output turns on. The output turns off when the input is turned off.

On February 16, 2012, when the input is turned on, the result of the current date compared with the ON and OFF settings is that the output is turned on.

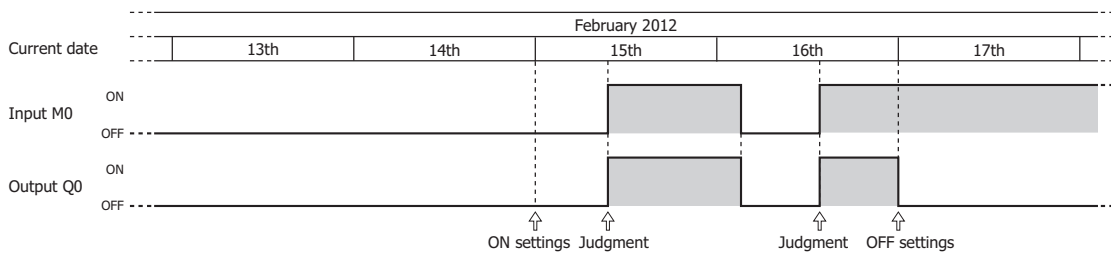

12: WEEK PROGRAMMER INSTRUCTIONS

• When pulse output is enabled

The input is determined to be on or off at 0:00 on the date of the ON settings and the output is turned on. The current date is not compared with the ON settings when the input is turned on.

Settings

| | |
|---------------------|--------------|
| P 1 tab ON settings | July 2, 2012 |
| P 2 tab ON settings | July 4, 2012 |
| Output port | Q0 |

Ladder program

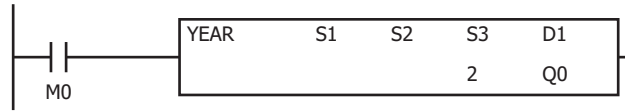

[When the input turns on before the day specified by the ON settings]

The result of the input being determined at 0:00 on July 2, 2012 is to turn on the output for one scan.

The result of the input being determined at 0:00 on July 4, 2012 is to turn on the output for one scan.

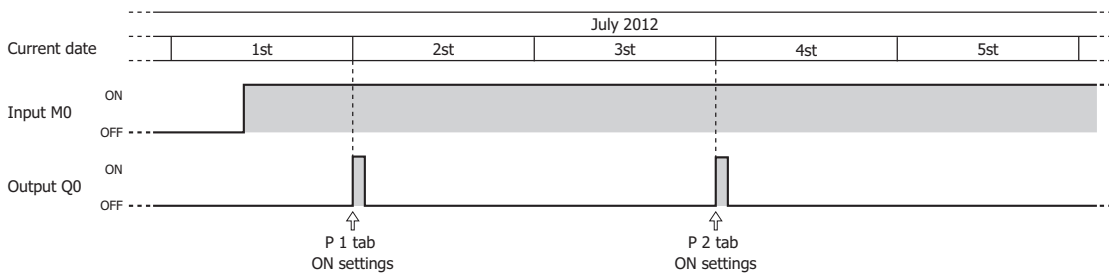

[When the input turns on exactly on the day specified by the ON settings]

When the input turns on at 0:00 on July 2, 2012, the output turns on for one scan.

When the input turns on after 0:00 on July 4, 2012, the output turns on for one scan.

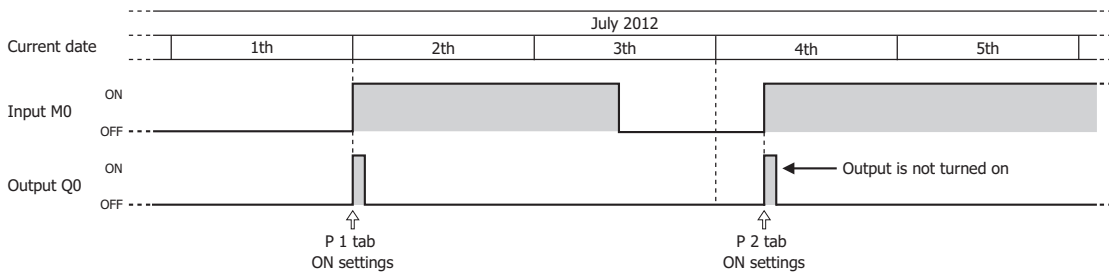

Examples: YEAR

- To configure the dates as fixed settings

[To turn on Q0 from 0:00 on September 1, 2011, to 0:00 on June 25, 2013]

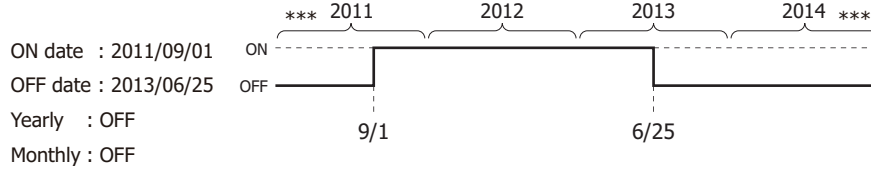

Parameter tab

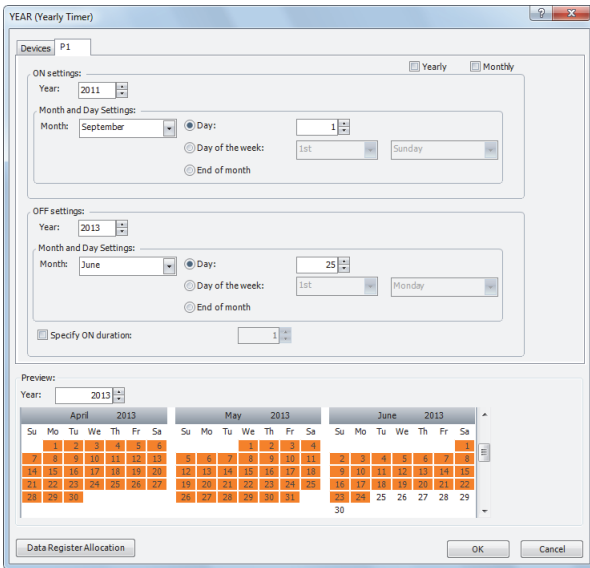

Configure the tab as shown above and set **D1** to Q0.

Ladder program

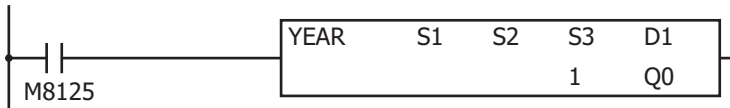

12: WEEK PROGRAMMER INSTRUCTIONS

[To turn on output Q0 from 0:00 on August 12 to 0:00 on August 15 every year]

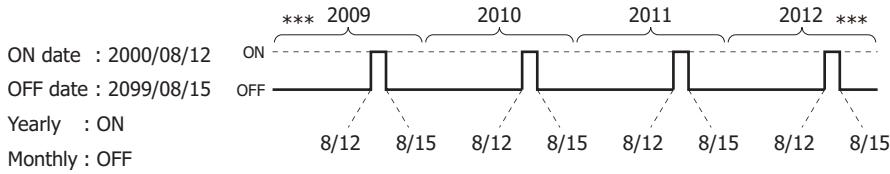

Parameter tab

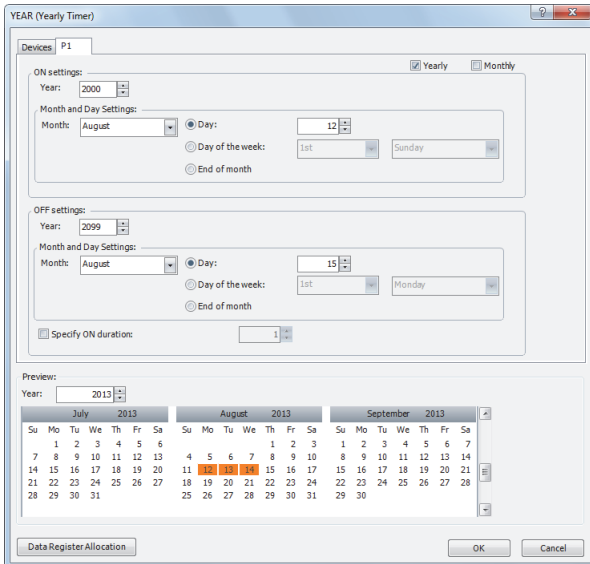

Configure the tab as shown above and set **D1** to Q0.

Ladder program

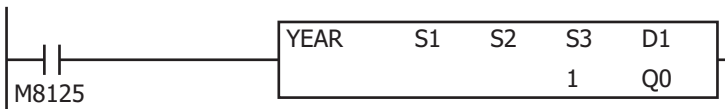

[To turn on output Q0 only on the 2nd Monday of each month from 2000 to 2099]

ON date : 2000/**/2nd Monday
 OFF date : 2099/**/2nd Monday + 1 day
 Yearly : ON
 Monthly : ON

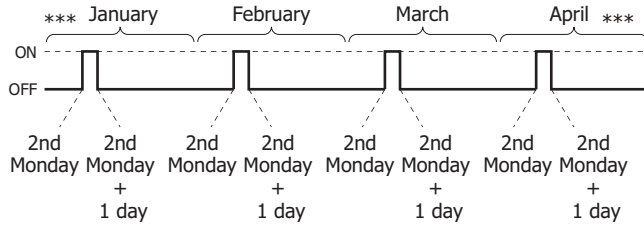

Parameter tab

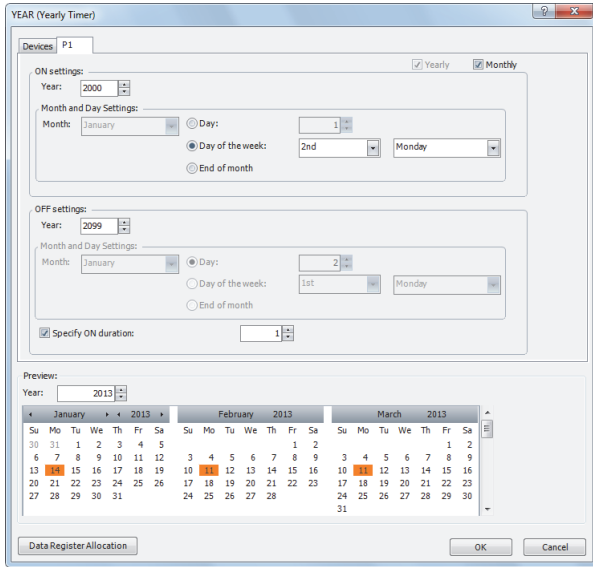

Configure the tab as shown above and set **D1** to Q0.

Ladder program

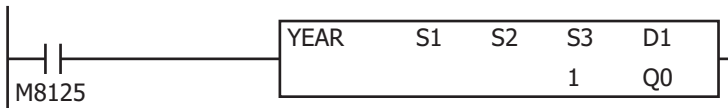

12: WEEK PROGRAMMER INSTRUCTIONS

[To turn on output Q000 on the last day of every month between 2013 and 2020]

ON date : 2013/**/end of month
 OFF date : 2020/**/end of month
 + 1 day

Yearly : ON

Monthly : ON

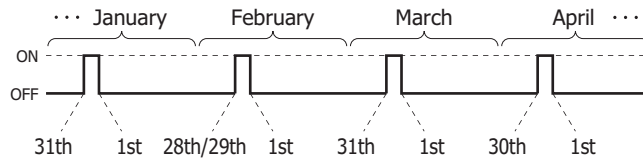

Parameter tab

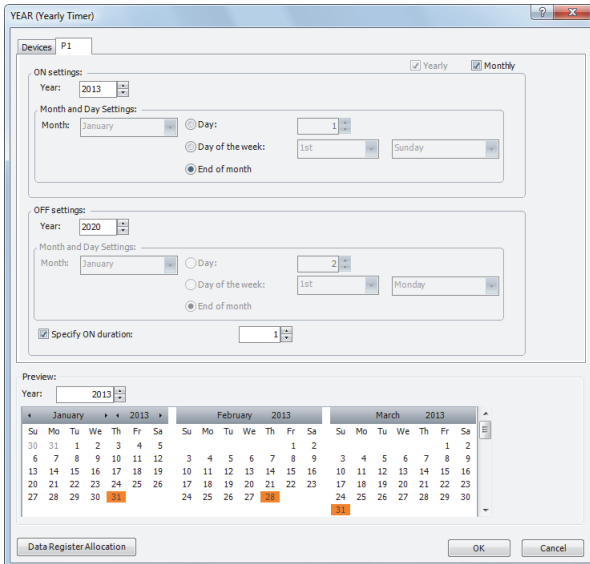

Configure the tab as shown above and set **D1** to Q0.

Ladder program

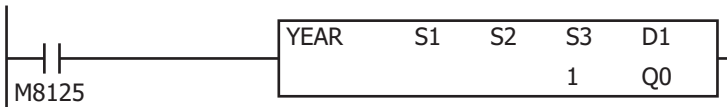

- To configure the dates by specifying data registers

[To turn on M100 from 0:00 on September 1, 2011, to 0:00 on June 25, 2013]

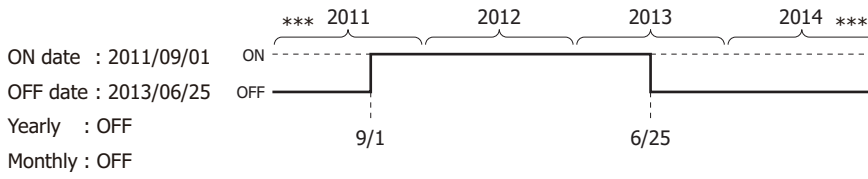

Device tab

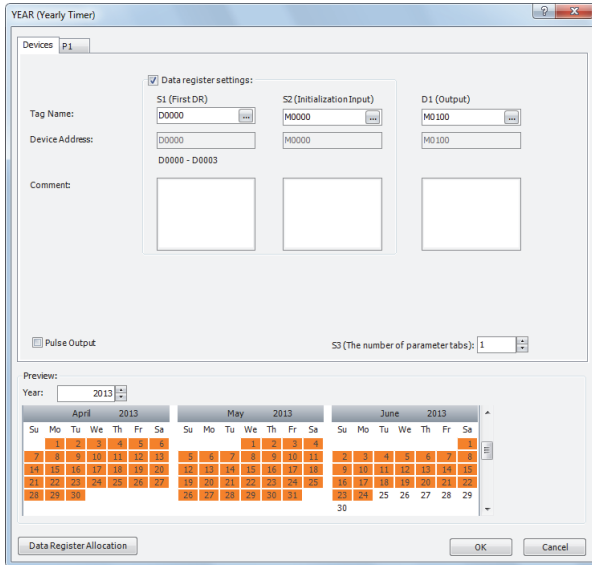

Parameter tab

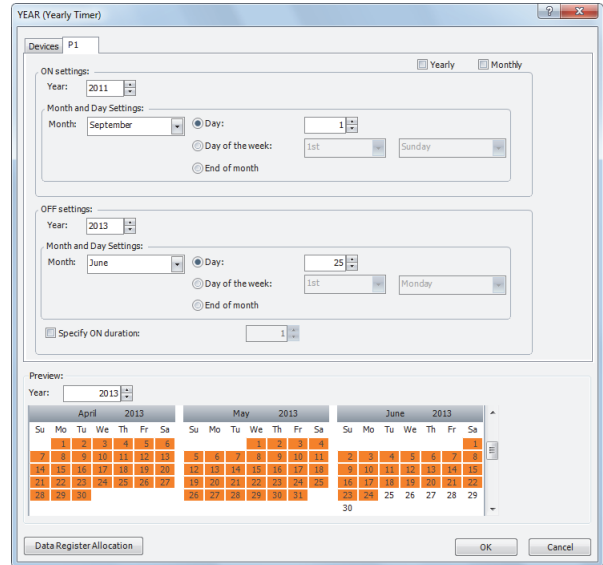

Data register allocation

The settings on the **P 1** tab are allocated to data registers D0 to D3 as shown in the table below. The settings configured on the **P 1** tab are stored in D0 to D3 by turning on initialization input S2.

| Data register | Setting | Initial setting |
|---------------|------------------------|----------------------------------|
| D0 | P 1 tab ON settings | Year: 2011 |
| D1 | | Month, Day: 2305 (September 1st) |
| D2 | OFF settings | Year: 2013 |
| D3 | | Month, Day: 1561 (June 25th) |

Ladder program

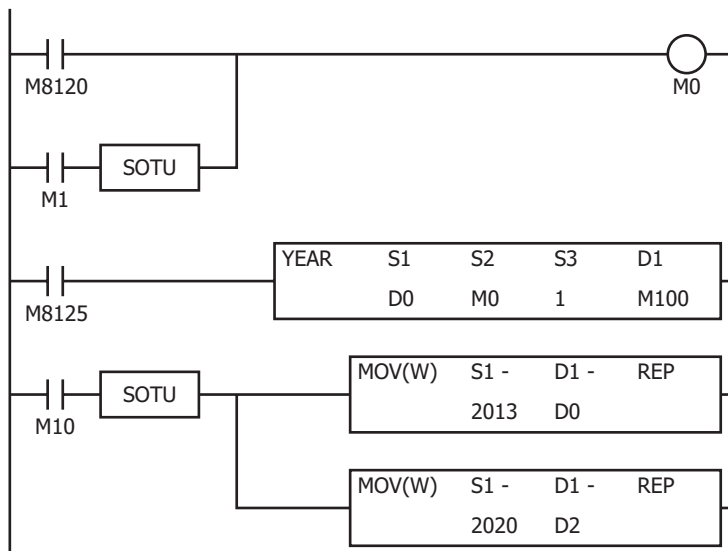

- The initial settings configured on the **P 1** tab are stored in D0 to D3 at the first scan.
- The YEAR instruction starts operating according to the values of data registers D0 to D3.
- When M10 turns on, the ON settings year changes to 2013 (D0) and the OFF settings year changes to 2020 (D2).
- When M1 turns on, all of the YEAR instruction settings (D0 to D3) return to the initial settings.

13: DISPLAY INSTRUCTIONS

Introduction

The display instructions display the specified data such as text and device values on the SmartAXIS LCD.

MSG (Message)

This instruction displays the specified data on the SmartAXIS LCD.

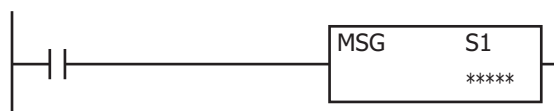

When the input turns on, a message is displayed on the LCD according to the content configured in the MSG instruction dialog box. The following types of data can be displayed.

Device values can be displayed.

- Word device values can be displayed as numeric values according to the specified data type.
For details, see "Insert Word Device" on page 13-4.
- Word device values can be displayed as bar graphs.
For details, see "Insert Bar Graph" on page 13-7.
- Text can be displayed and switched according to the value of a bit device (input/output, internal relay, shift register, timer contact, or counter contact).
For details, see "Insert Bit Device" on page 13-5.

Arbitrary text can be displayed.

- The specified text can be displayed.
For details, see "Edit MSG (Message) dialog box" on page 13-2.

The text display effects can be configured.

- Text can be scrolled, blinked, or inverted.
For details, see "Insert Text with Effect" on page 13-6.

Date/time data can be displayed.

- The current date/time and the date/time when the input to the MSG instruction is turned on can be displayed on the LCD.
For details, see "7. Special Data" on page 13-3.

The language for displayed text can be selected from 9 languages.

- Text can be displayed in 9 languages using 4 types of character sets.
For details, see "MSG Instruction Common Settings" on page 13-8.

The text display settings can be configured.

- The scroll unit, scroll speed, and blinking speed can be configured.
For details, see "MSG Instruction Common Settings" on page 13-8.

Device values can be modified.

- Device values displayed with the MSG instruction can be modified on the SmartAXIS.
For details, see "Modifying Device Values on the SmartAXIS" on page 13-16.

Notes:

- A maximum of 50 MSG instructions can be entered in a user program. Only one MSG instruction message can be displayed on the LCD. S1 for the MSG instruction stores the MSG instruction priority. When the display conditions for multiple MSG instructions are satisfied, the messages are displayed according to the priority set for the MSG instruction.
For MSG instruction priority, see "10. Priority" on page 13-3.
- The MSG instruction cannot be used during an interrupt program. If it is used during an interrupt program, a user program execution error occurs, the execution of the instruction is canceled, and the next instruction is executed.
For user program execution errors, see "User Program Execution Errors" on page 4-13.

Applicable SmartAXIS

| FT1A-12 | FT1A-24 | FT1A-40 | FT1A-48 | FT1A-Touch |
|---------|---------|---------|---------|------------|
| ▲ | ▲ | ▲ | ▲ | — |

▲ For Pro only (The display instructions cannot be used on Lite.)

Valid Devices

| Device | Function | I | Q | M | R | T | C | D | Constant | Repeat |
|---------------|----------|---|---|---|---|---|---|---|----------|--------|
| S1 (Source 1) | Priority | — | — | — | — | — | — | — | X | — |

*1 Special internal relays cannot be used.

13: DISPLAY INSTRUCTIONS

Settings

For the MSG instruction settings, there are settings for the individual MSG instruction and settings that are common to all the MSG instructions.

Note: Settings that are common to all the MSG instructions are modified in the Function Area Settings dialog box of WindLDR. For details, see "MSG Instruction Common Settings" on page 13-8.

■MSG Instruction Individual Settings

The settings for the individual MSG instruction, such as texts and devices to display and the priority, can be configured in the Edit MSG instruction dialog box.

Edit MSG (Message) dialog box

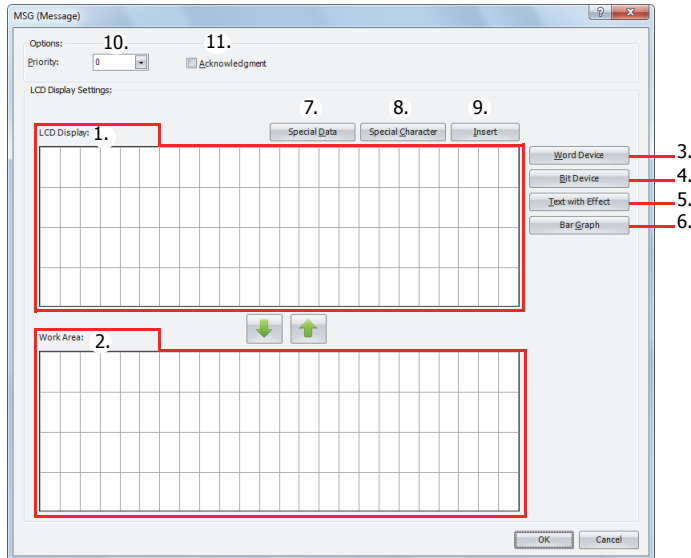

1. LCD Screen

The screen displayed on the SmartAXIS LCD when the MSG instruction is executed can be configured in this area. Enter characters at the cursor position using the keyboard. The character input method (insert/overwrite) is changed by clicking **Insert** (9).

Note: Text entered on the LCD Screen (1) with the keyboard cannot be set to scroll, blink, or invert. To scroll, blink, or invert the text, enter the text with **Text with Effects** (5) and configure the display options. For details on inserting text with effects, see "Insert Text with Effect" on page 13-6.

2. Work Area

This area is used when editing the LCD screen. This area is for temporarily relocating text and device data.

Text and device data be moved between the LCD Screen and the Work Area with  or .

When the dialog is closed, the work area data is discarded.

3. Word Device

Inserts a word device at the cursor position. The value of the specified word device is displayed on the SmartAXIS LCD. For details, see "Insert Word Device" on page 13-4.

4. Bit Device

Inserts a bit device in the area specified by the cursor. Two different items of text can be switched between and displayed on the SmartAXIS LCD according to the value of the specified bit device. For details, see "Insert Bit Device" on page 13-5.

5. Text with Effects

Inserts text in the area specified by the cursor. The specified text is displayed on the SmartAXIS LCD. For details, see "Insert Text with Effect" on page 13-6.

6. Bar Graph

Inserts a bar graph in the area specified by the cursor. The value of the specified device is displayed as a bar graph on the SmartAXIS LCD. For details, see "Insert Bar Graph" on page 13-7.

7. Special Data

Special data such as the current date and time can be entered at the cursor position. Select the data to enter on the special data list window popped up when **Special Data** is pressed. Size of the area used on the LCD screen varies based on the selected special data.

| Special data | Display | | Occupied Area (Lines x columns) |
|--|--------------|--|------------------------------------|
| | Display type | Display example (January 1, 2012, 13:30) | |
| Current date | YYYY/MM/DD | 2012/01/01 | 1 x 10 |
| Current time | HH:MM | 13:30 | 1 x 5 |
| Date the input to the MSG instruction is turned on | YYYY/MM/DD | 2012/01/01 | 1 x 10 |
| Time the input to the MSG instruction is turned on | HH:MM | 13:30 | 1 x 5 |

8. Special Character

A special character can be entered at the cursor position. Select the character to enter on the special characters list window popped up when **Special Character** is pressed. The special characters that can be used are as follows.

| Special characters list | | | | | | | |
|-------------------------|---|---|---|----|----|---|---|
| ▼ | ▲ | ◀ | ▶ | °C | °F | ° | ± |



9. Insert/Overwrite

Selects insert or overwrite as the character input mode. Click this button to switch the input mode.

10. Priority

The priority of the MSG instruction can be configured between 0 to 49. 0 is the highest priority and 49 is the lowest priority.

- The same priority cannot be set for multiple MSG instructions.
- When inputs to two or more MSG instructions turns on, the message of the MSG instruction with the highest priority is displayed, out of all the MSG instructions with inputs that are on.
- When the MSG instruction input with the highest priority changes from on to off, the message for the MSG instruction with the next highest priority is displayed (the priority is checked when the input changes).
- If **Acknowledgement** (11) is enabled for the MSG instruction with the highest priority, even after the input changes from on to off, the same message is kept displayed. The message for the MSG instruction with the next highest priority is displayed when the SmartAXIS module  (OK) button is pressed.

Note: When you press the  (up) or  (down) button on the SmartAXIS, the messages are switched between the MSG instructions that have inputs that are on. Messages are also switched when the acknowledgement for the MSG instruction is enabled.

```
Motor 5
STOP AT
10:12
!! ACTION !!
```

Example: Message output in Priority 30



```
Motor 2
3000
hours
!! MAINTENANCE !!
```

Example: Message output in Priority 10

```
Running
2012/OCT/01/MON
09:00:12
```

Date and current time

11. Acknowledgment

When acknowledgement is enabled, the message is kept displayed even after the input to the MSG instruction is turned off. The message is closed when  (OK) button on the SmartAXIS is pressed, and then the message for the MSG instruction with the next highest priority is displayed, out of all the MSG instructions with inputs that are on at that time. If the input to the MSG instruction is on, the message is not closed even when the  (OK) button is pressed.

13: DISPLAY INSTRUCTIONS

Insert Word Device

The value of the specified word device can be displayed on the SmartAXIS LCD.

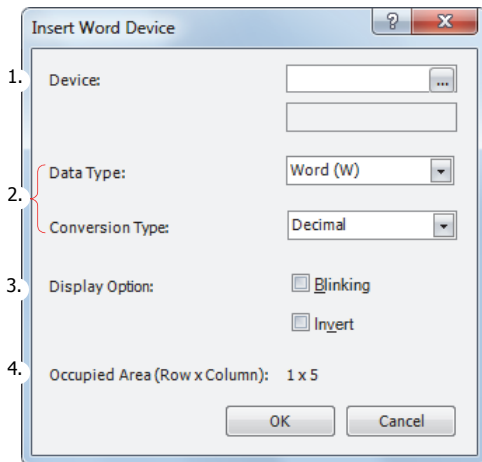

1. Device

Enter the device to display.

Valid Devices

| | |
|------------------------|-------------------|
| W (word) | TC, TP, CC, CP, D |
| I (integer) | D |
| D (double word) | CC, CP, D |
| L (long) | D |
| F (float) | D |

2. Data Type and Conversion Type

Select the display type for the specified device. The size of the area used on the LCD screen varies based on the specified data type and conversion type.

| Data Type | Conversion Type | Occupied Area | Example on LCD |
|-----------------|-----------------|---------------|----------------|
| W (word) | Decimal | 5 | 65535 |
| | Hexadecimal | 4 | FFFF |
| I (integer) | Decimal | 6 | -32768 |
| D (double word) | Decimal | 10 | 4294967295 |
| | Hexadecimal | 8 | FFFFFFFF |
| L (long) | Decimal | 11 | -2147483648 |
| F (float) | Decimal | 13 | -3.402823E+38 |

3. Display Options

Configure the options to blink or invert the value of the specified device. For the blinking speed, see "MSG Instruction Common Settings" on page 13-8.

| Display Options | Description |
|-----------------|---|
| Blinking | Blinks the value of the specified device. |
| Invert | Inverts the display of the specified value. |

4. Occupied Area

Shows the size of the area to be used on the LCD screen (Lines: 1, columns: 4 to 13). The area is determined by the selected data type and conversion type.

Insert Bit Device

Two different items of text can be switched between and displayed on the SmartAXIS LCD according to the value of the specified bit device (when on/when off).

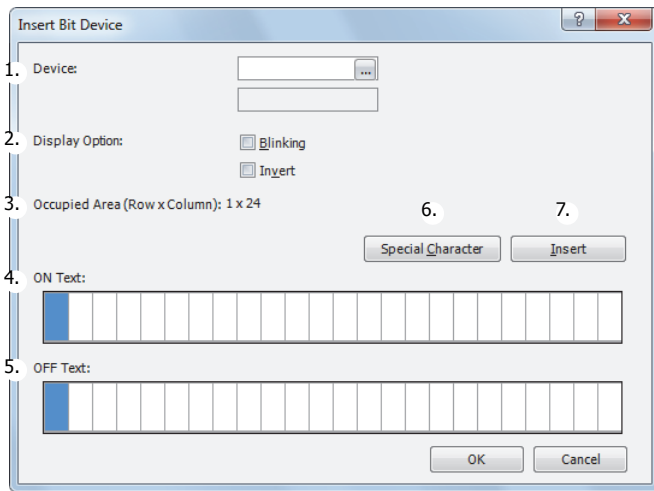

1. Device

Enter the device to display.

Valid Devices

| I | Q | M | R | T | C | D |
|---|---|---|---|---|---|---|
| X | X | X | X | X | X | — |

2. Display Options

Configure the options to blink or invert the text. For the blinking speed, see "MSG Instruction Common Settings" on page 13-8.

| Display Options | Description |
|-----------------|--|
| Blinking | Blinks the specified text. |
| Invert | Inverts the display of the specified text. |

3. Occupied Area

Shows the size of the area to be used on the LCD screen (Lines: 1, columns: 1 to 24). The display size is determined by the selected range on the LCD screen area (or work area). If multiple lines are selected, the area at the top line in the selected range is used.

4. ON Text

Enter the text to display when the specified device is on. Up to 24 single-byte characters can be entered. A space is also counted as one character.

5. OFF Text

Enter the text to display when the specified device is off. Up to 24 single-byte characters can be entered. A space is also counted as one character.

6. Special Character

Enters a special character at the cursor position. Select the character to enter on the special characters list window popped up when **Special Character** is pressed. For the special characters, see "8. Special Character" on page 13-3.

7. Insert/Overwrite

Selects whether to insert or overwrite characters when entering new characters.

13: DISPLAY INSTRUCTIONS

Insert Text with Effect

The specified text can be displayed on the SmartAXIS LCD.

[When scrolling is disabled]

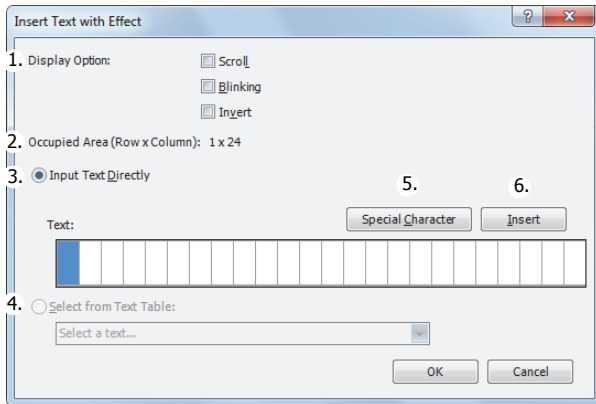

[When scrolling is enabled]

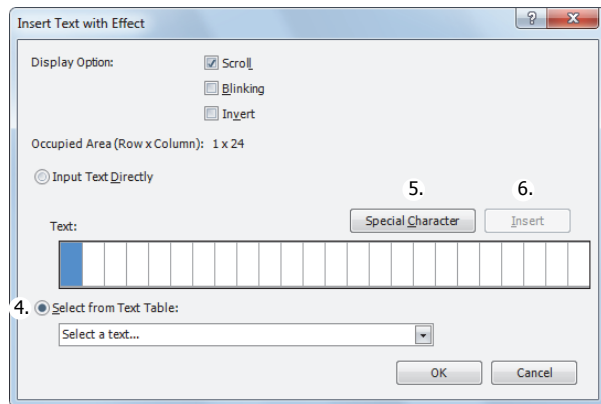

1. Display Options

Configure the options to scroll, blink, or invert the specified text. For the scroll unit, scroll speed, and blinking speed, see "MSG Instruction Common Settings" on page 13-8.

| Display Options | Description |
|-----------------|---|
| Scroll | Scrolls the specified text. |
| Blinking | Blinks the specified text. |
| Invert | Invert the display of the specified text. |

2. Occupied Area

Shows the size of the area to be used on the LCD screen (Lines: 1, columns: 1 to 24). The occupied area is determined by the selected range on the LCD screen area (or work area). If multiple lines are selected, the area at the top line in the selected range is used.

3. Input Text Directly

Directly enter the characters to display. A space is also counted as one character. If scrolling is disabled, the message can be entered up to 24 single-byte characters. However, you cannot enter a number of characters that exceeds the occupied area. If scrolling is enabled, the message can be entered up to 48 single-byte characters.

4. Select from Text Manager

Select the text to display from the text manager. This can be selected only when the scroll is enabled.

5. Special Character

Enters a special character at the cursor position. Select the character to enter on the special characters list window popped up when **Special Character** is pressed. For the special characters, see "8. Special Character" on page 13-3.

6. Insert/Overwrite

Selects whether to insert or overwrite characters when entering new characters.

Insert Bar Graph

The value of the specified device can be displayed as a bar graph on the SmartAXIS LCD.

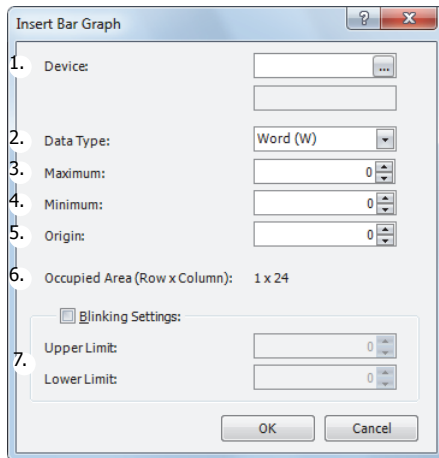

1. Device

Enter the device to display as a bar graph.

Valid Devices

| | |
|------------------------|-------------------|
| W (word) | TC, TP, CC, CP, D |
| I (integer) | D |
| D (double word) | CC, CP, D |
| L (long) | D |
| F (float) | — |

2. Data Type

Selects the data type for the specified device.

Data Type

| | |
|------------------------|---|
| W (word) | X |
| I (integer) | X |
| D (double word) | X |
| L (long) | X |
| F (float) | — |

For data types, see "Data Types for Advanced Instructions" on page 4-10.

3. Maximum

Enter the maximum value for the bar graph. If the device value is larger than the maximum value, the bar graph is displayed as the maximum value. The valid range varies based on the data type. See "Data Types for Advanced Instructions" on page 4-10.

4. Minimum

Enter the minimum value for the bar graph. If the device value is smaller than the minimum value, the bar graph is displayed as the minimum value. The valid range varies based on the data type. See "Data Types for Advanced Instructions" on page 4-10.

5. Origin

Enter the value to be the origin of the bar graph. If the device value is larger than the origin value, the bar graph is displayed on the right side of the origin value. If the device value is smaller than the origin value, the bar graph is displayed on the left side of the origin value. The valid range varies based on the data type. See "Data Types for Advanced Instructions" on page 4-10. The origin value must satisfy the condition of $\text{Minimum} \leq \text{Origin} \leq \text{Maximum}$.

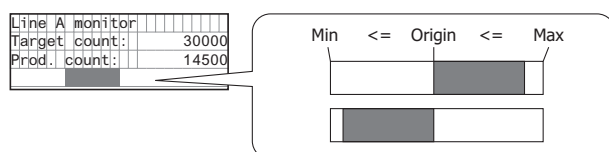

6. Occupied Area

The occupied area is determined by the selected range on the LCD screen area (or work area). If multiple lines are selected, the area at the top line in the selected range is used (Lines: 1, columns: 1 to 24).

13: DISPLAY INSTRUCTIONS

7. Blinking Settings

Blink the bar graph when the value of the specified device exceeds the upper or lower limit.
For the blinking speed, see "MSG Instruction Common Settings" on page 13-8.

| Blinking Settings | Description |
|-------------------|--|
| Upper limit | The bar graph is blinked when the value of the specified device is larger than the upper limit. |
| Lower limit | The bar graph is blinked when the value of the specified device is smaller than the lower limit. |

Maximum, minimum, upper limit, and lower limit values must satisfy the following condition.

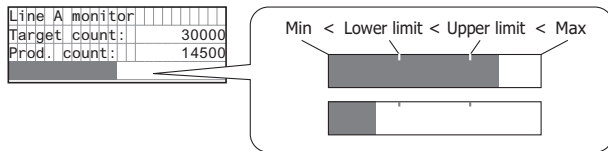

■MSG Instruction Common Settings

The common settings, character set, scroll unit, scroll speed, and blinking speed, for the message to display can be configured. The common settings are configured in the WindLDR Function Area Settings dialog box.

Note: The common settings for the MSG instructions are applicable for all MSG (message) instructions in the user program. For the MSG instruction individual settings, see "MSG Instruction Individual Settings" on page 13-2.

Function Area Settings dialog box

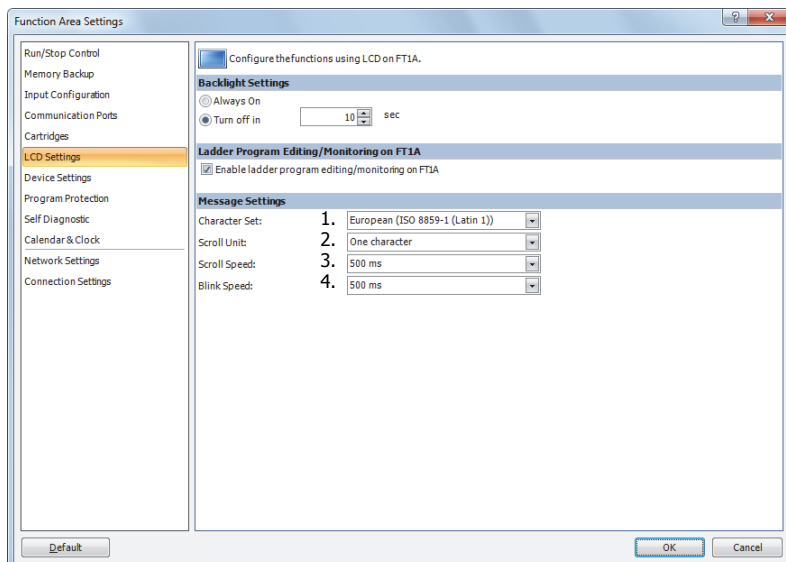

1. Character Set

The character set used for the messages can be configured from the following.

| Selection | Character Set | Languages usable in the MSG instruction |
|-----------|----------------------|--|
| European | ISO-8859-1 (Latin 1) | Italian, English, Dutch, Spanish, German, French |
| Japanese | Shift-JIS | Japanese |
| Chinese | GB2312 | Chinese (simplified) |
| Cyrillic | ANSI 1251 | Russian |

2. Scroll Unit

The unit to scroll the texts can be configured.

| | |
|-------------|--|
| 1 character | Scrolls the text in 1 character units. |
| 1 dot | Scrolls the text in 1 dot units. |

3. Scroll Speed

The speed to scroll the texts can be configured. The setting range is 500 to 1000 ms.

4. Blinking Speed

The speed to blink the texts can be configured. The setting range is 500 to 1000 ms.

Note: The MSG instruction character set can be configured irrespective of the SmartAXIS system menu language.

MSG Instruction Configuration Example

[Display the room temperature when M0000 is on and the outdoor temperature when M0000 is off]

The room temperature/outdoor temperature value is stored in D0002.

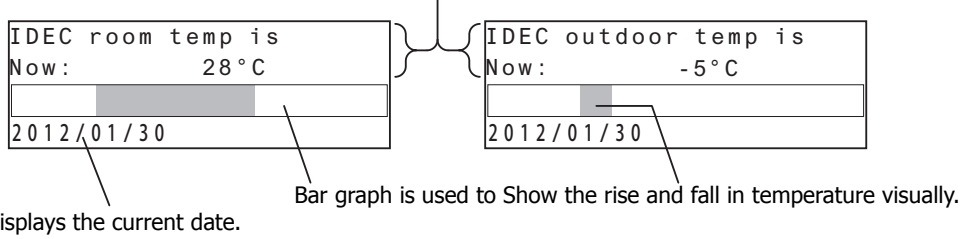

Settings

Configure the following items.

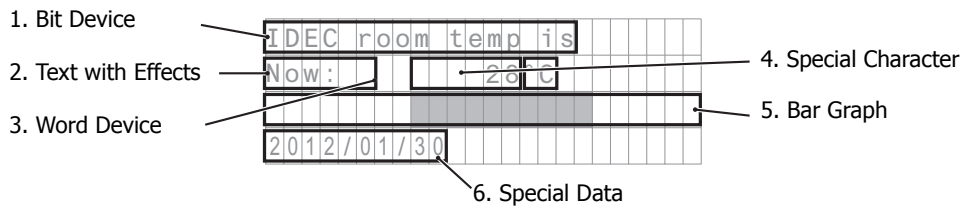

| Setting items | | Setting details |
|----------------------|-------------------|--------------------------------------|
| 1. Bit Device | Device | M0000 |
| | Display Options | All disabled (scroll, blink, invert) |
| | ON Text | IDEC room temp is: |
| | OFF Text | IDEC outdoor temp is: |
| 2. Text with Effects | Text | Now: |
| | Display Options | All disabled (scroll, blink, invert) |
| 3. Word Device | Device | D0002 |
| | Data Type | I (integer) |
| | Conversion Type | Decimal |
| 4. Special Character | | °C |
| 5. Bar Graph | Device | D0002 |
| | Data Type | I (integer) |
| | Max | 50 |
| | Min | -20 |
| | Origin | 0 |
| | Blinking Settings | Disabled |
| 6. Special Data | | Current date |

13: DISPLAY INSTRUCTIONS

■ Operation Procedure

1. On the WindLDR right-click menu, click **Advanced Instructions > Display > MSG (Message)**.
2. The MSG (Message) dialog box opens.

Configuring the bit device

3. Select the area to insert the parameter and click **Bit Device**.

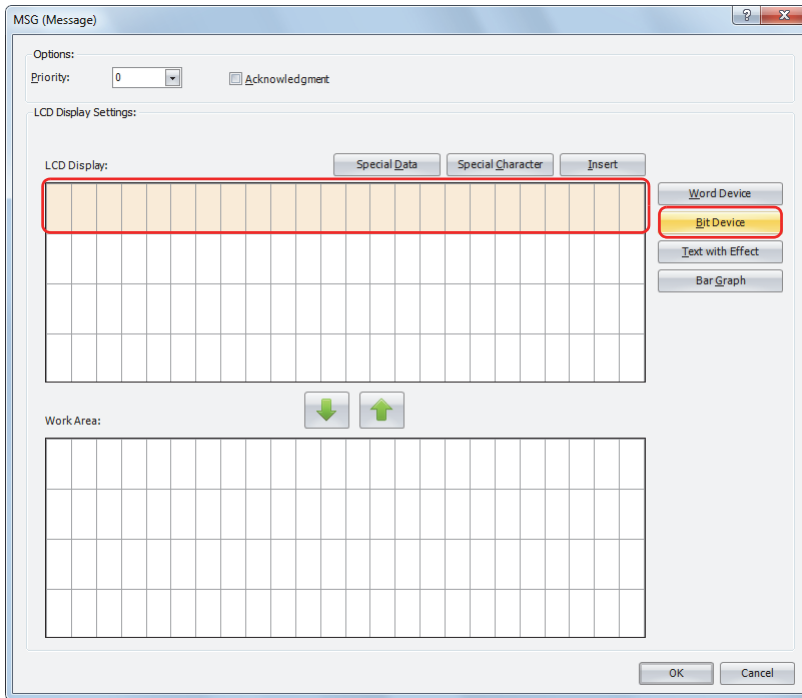

The Insert Bit Device dialog box opens.

4. Configure the parameters so that the room temperature is displayed when M0000 is on and the outdoor temperature is displayed when M0000 is off. Set **Device** to "M0000". Using the keyboard, enter "IDEC room temp is:" as the ON Text and "IDEC outdoor temp is:" as the OFF Text. Under **Display Options**, disable all of the options.

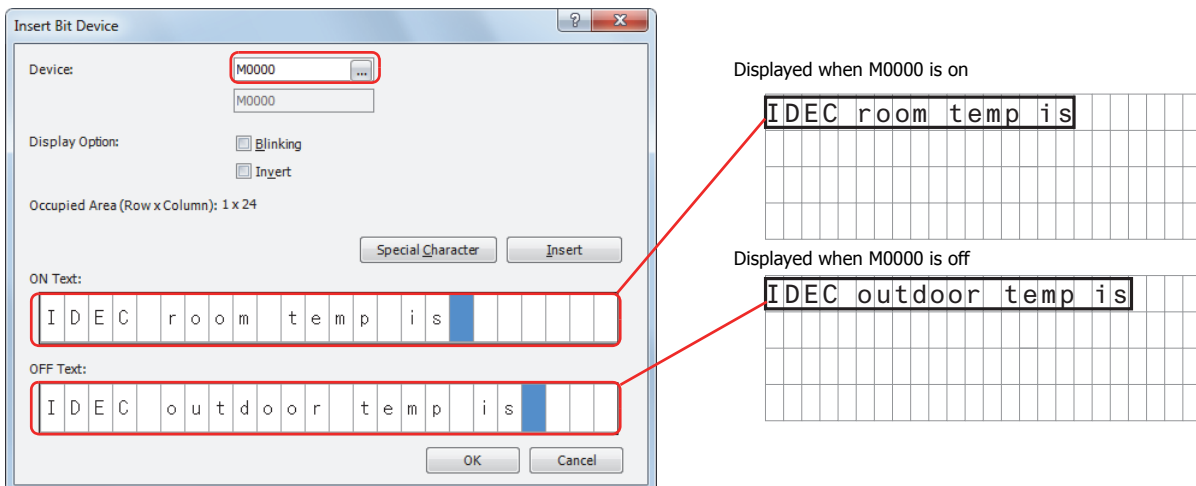

- After the settings are configured, click **OK**.
The configured content is displayed on the LCD screen area.

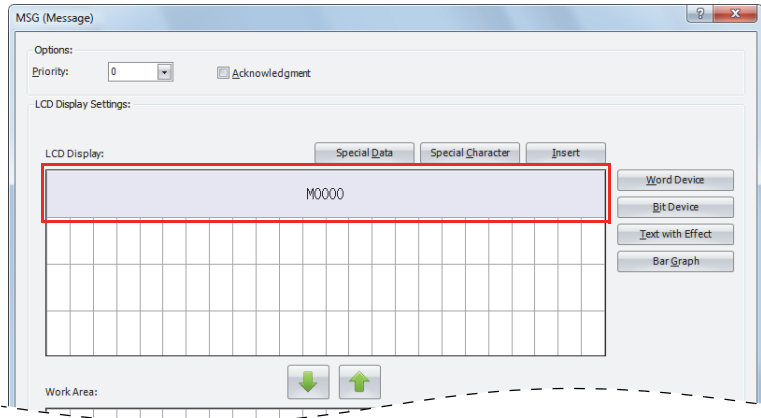

Configuring the text with effect

- Select the six-column area from the start of the second line and click **Text with Effect**.

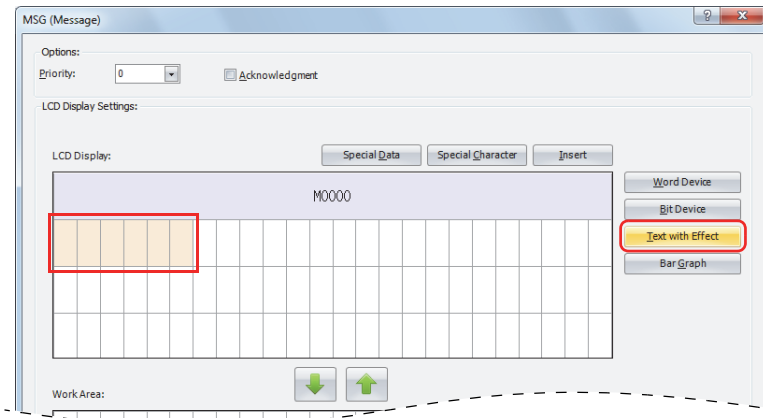

Note: The text can also be entered directly on the LCD screen area. In the sample above, move the cursor to the start of the second line and enter "Now:" with the keyboard. When you directly enter the text, proceed to "Configuring the word device" on page 13-12, step 9.

The Insert Text with Effect dialog box opens.

- In Text, enter "Now:" with the keyboard. Under **Display Options**, disable all of the options.

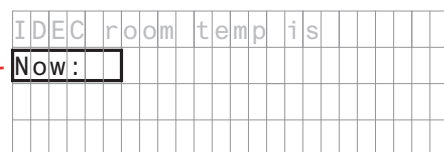
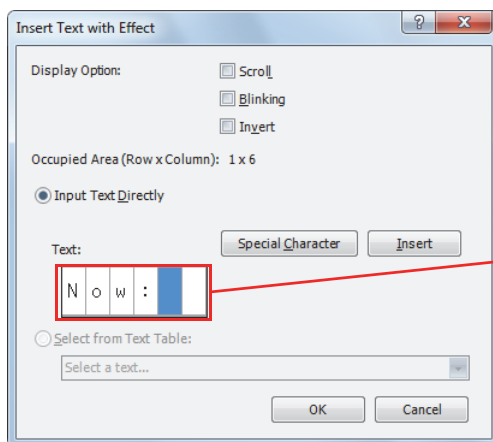

13: DISPLAY INSTRUCTIONS

- After the settings are configured, click **OK**.
The configured content is displayed on the LCD screen area.

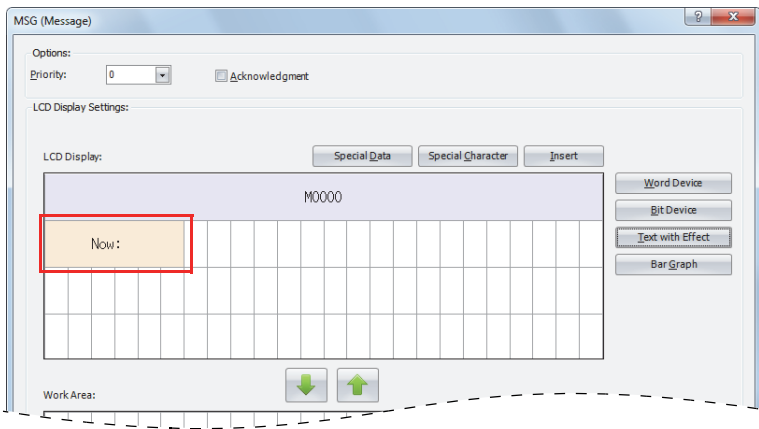

Configuring the word device

- Select the area at the ninth column on the second line and click **Word Device**.

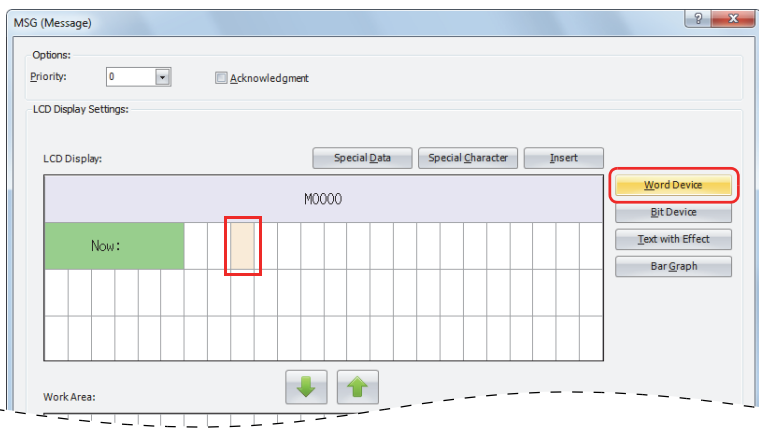

The Insert Word Device dialog box opens.

- Set **Device** to "D0002", **Data Type** to **I (Integer)**, and **Conversion Type** to **Decimal**.
Under **Display Options**, disable all of the options.

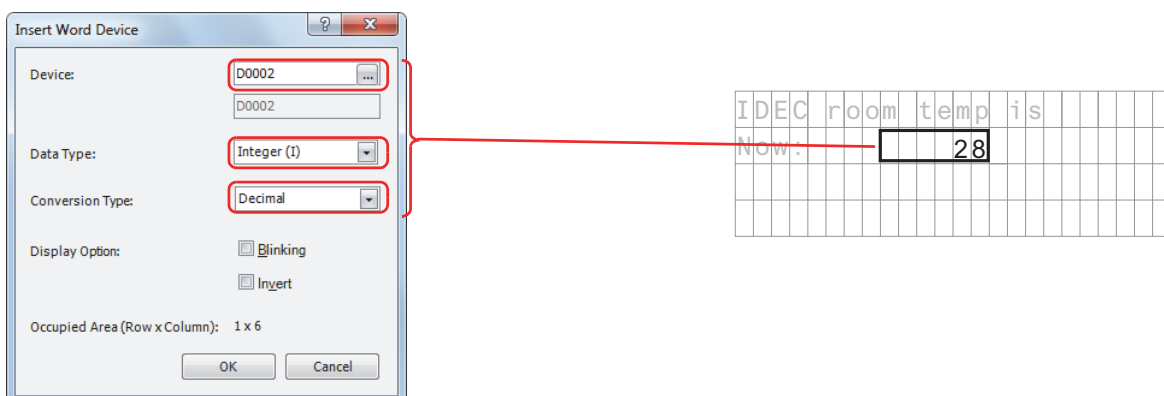

- After the settings are configured, click **OK**.
The configured content is displayed on the LCD screen area.

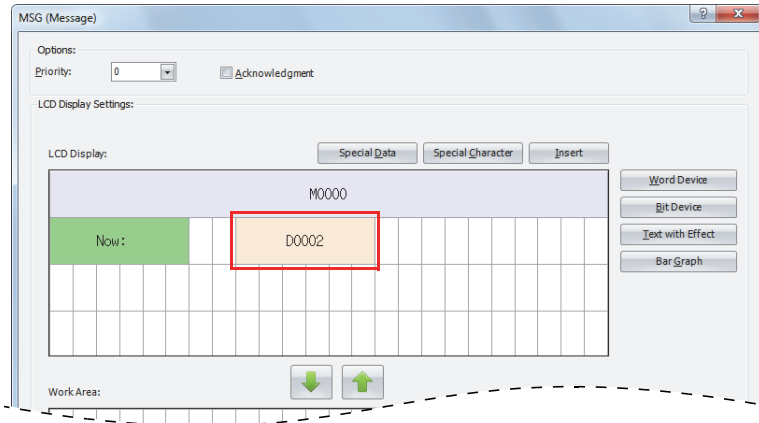

Configuring the special character

- Select the area at the 15th column on the second line and click **Special Character**.

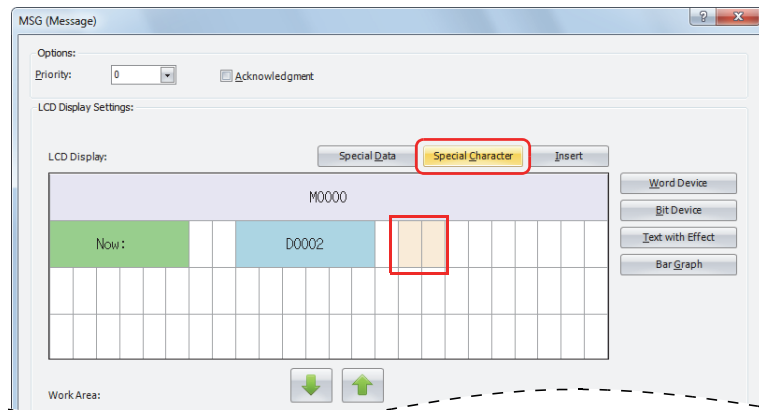

The **Special Characters List** window is popped up.

- Double-click on **°C**.



The configured content is displayed on the LCD screen area.

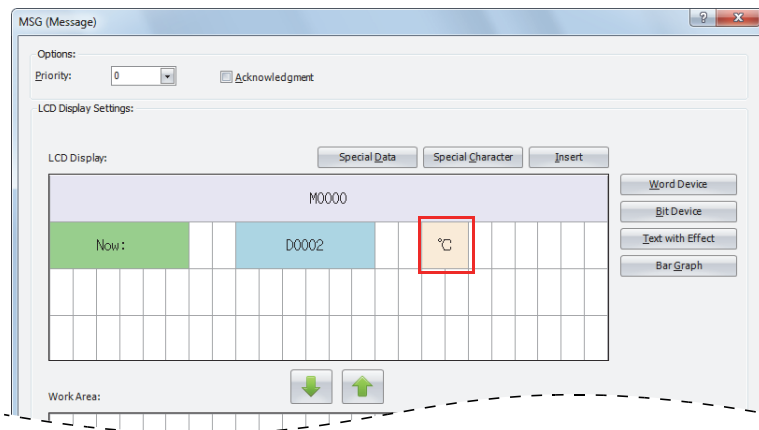

13: DISPLAY INSTRUCTIONS

Configuring the bar graph

14. Select the entire area on the third line and click **Bar Graph**.

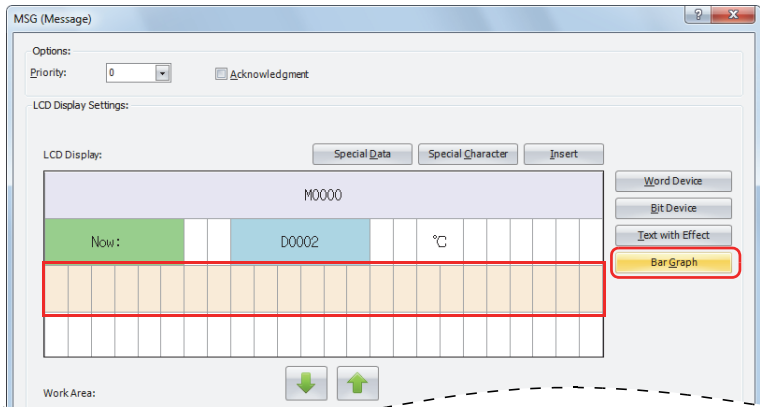

The Insert Bar Graph dialog box opens.

15. Set **Device** to "D0002", **Data Type** to "Integer (I)", **Max** to "50", **Min** to "-20", and **Origin** to "0".
Disable the blinking settings.

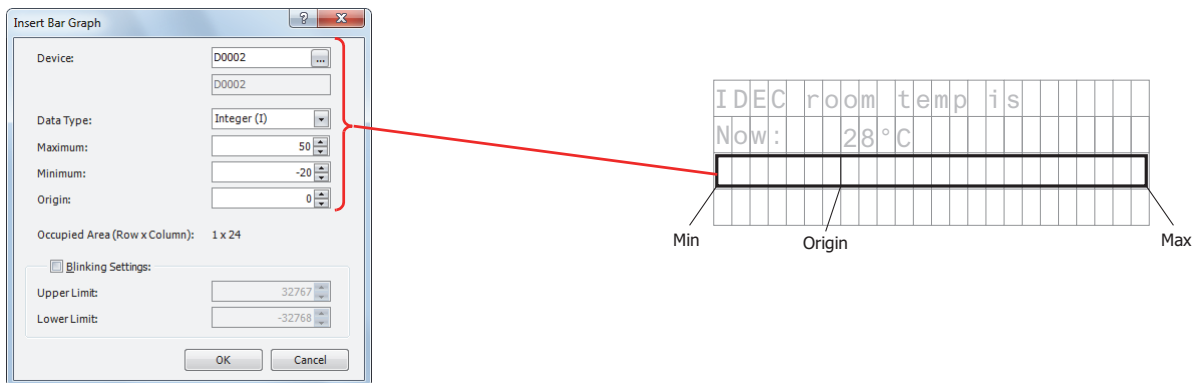

16. After the settings are configured, click **OK**.

The configured content is displayed on the LCD screen area.

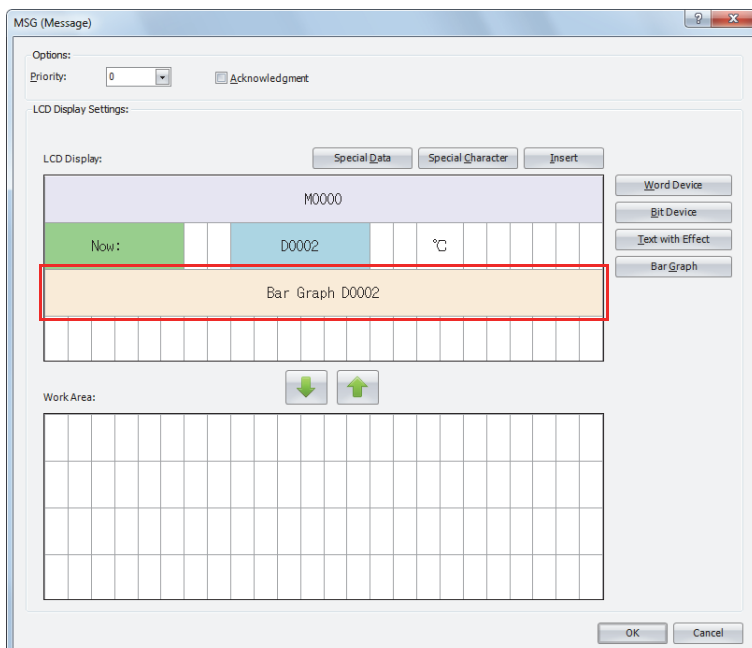

Configuring the special data

17. Select the left edge of the fourth line and click **Special Data**.

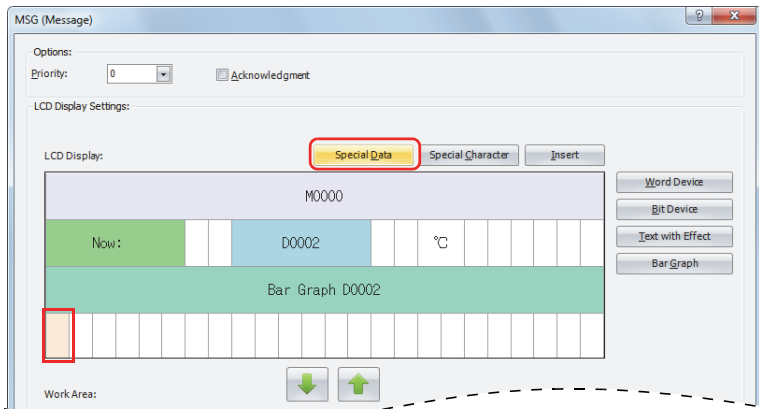

The **Special Data List** window is popped up.

18. Double-click on the **Current date**.

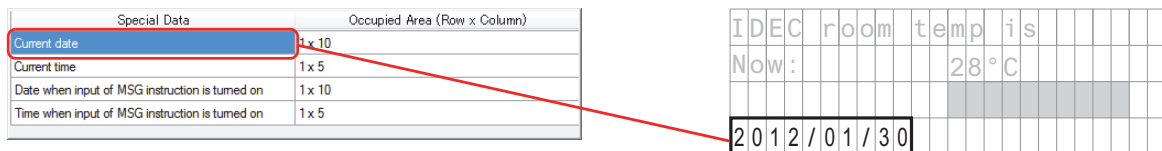

19. After the settings are configured, click **OK**.

The configured content is displayed on the LCD screen area.

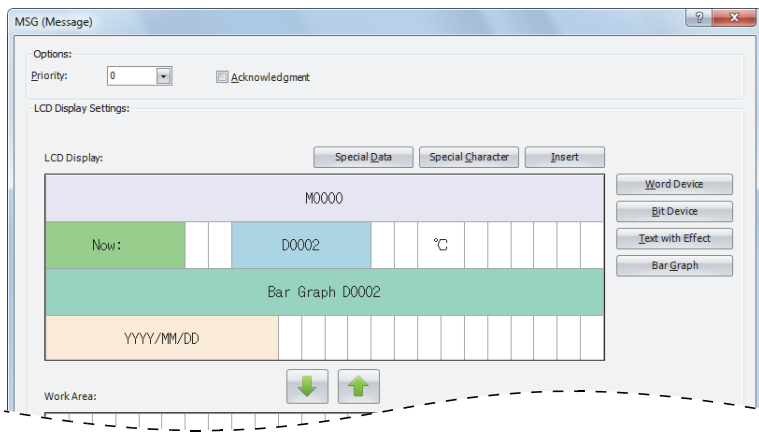

This concludes configuring the settings.

LCD display

When M0000 is on, the room temperature stored in D0002 is displayed as the numeric value (°C) and bar graph.

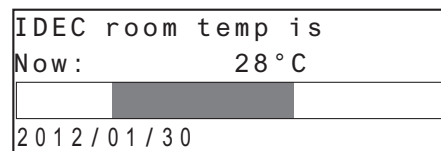

When M0000 is off, the outdoor temperature stored in D0002 is displayed as the numeric value (°C) and bar graph.

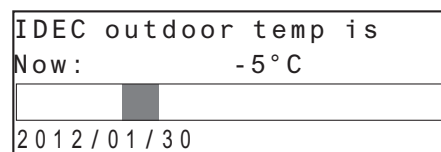

13: DISPLAY INSTRUCTIONS

Modifying Device Values on the SmartAXIS

The values of the word devices displayed on the SmartAXIS LCD can be modified using the SmartAXIS operation buttons. The values cannot be modified when the SmartAXIS is stopped.

[To modify the value of word device CP0]





| | | | | | | | | | |
|----------------|-----|---------|-----|--|--|--|--|--|--|
| Line A monitor | | | | | | | | | |
| Plan: | CP0 | Actual: | CC0 | | | | | | |
| Diff: | D0 | | | | | | | | |
| Bar Graph CC0 | | | | | | | | | |

When the SmartAXIS is running and the input to the MSG instruction is turned on, the following screen will be displayed on the LCD.



| | | | | | | | | | |
|----------------|-------|---------|-------|--|--|--|--|--|--|
| Line A monitor | | | | | | | | | |
| Plan: | 60000 | Actual: | 20000 | | | | | | |
| Diff: | 40000 | | | | | | | | |
| Bar Graph CC0 | | | | | | | | | |

While the above message is displayed, press and hold the  (OK) button and the cursor is displayed on the devices that can be modified.

| | | | | | | | | | |
|----------------|-------|---------|-------|--|--|--|--|--|--|
| Line A monitor | | | | | | | | | |
| Plan: | 60000 | Actual: | 20000 | | | | | | |
| Diff: | 40000 | | | | | | | | |
| Bar Graph CC0 | | | | | | | | | |

Move the cursor to the device you wish to edit using the  (up)  (down)  (left)  (right) buttons and press the  (OK) button to change the device in the editable state.

| | | | | | | | | | |
|----------------|-------|---------|-------|--|--|--|--|--|--|
| Line A monitor | | | | | | | | | |
| Plan: | 60000 | Actual: | 20000 | | | | | | |
| Diff: | 40000 | | | | | | | | |
| Bar Graph CC0 | | | | | | | | | |

Press the  (right) button to move the cursor to the fourth digit, and then use the  (up) button to modify the target value to "65000".

| | | | | | | | | | |
|----------------|-------|---------|-------|--|--|--|--|--|--|
| Line A monitor | | | | | | | | | |
| Plan: | 65000 | Actual: | 20000 | | | | | | |
| Diff: | 40000 | | | | | | | | |
| Bar Graph CC0 | | | | | | | | | |

Press the  (OK) button to confirm the modifications.

| | | | | | | | | | |
|----------------|-------|---------|-------|--|--|--|--|--|--|
| Line A monitor | | | | | | | | | |
| Plan: | 65000 | Actual: | 20000 | | | | | | |
| Diff: | 40000 | | | | | | | | |
| Bar Graph CC0 | | | | | | | | | |

Scrolling text example

[Character Set: European scroll speed: 500 ms]

When a text with effect is set to scroll, the text is displayed on the SmartAXIS LCD as follows.

When scrolling a text longer than the specified area on the LCD

Text: "IDEC Corporation SmartAXIS"

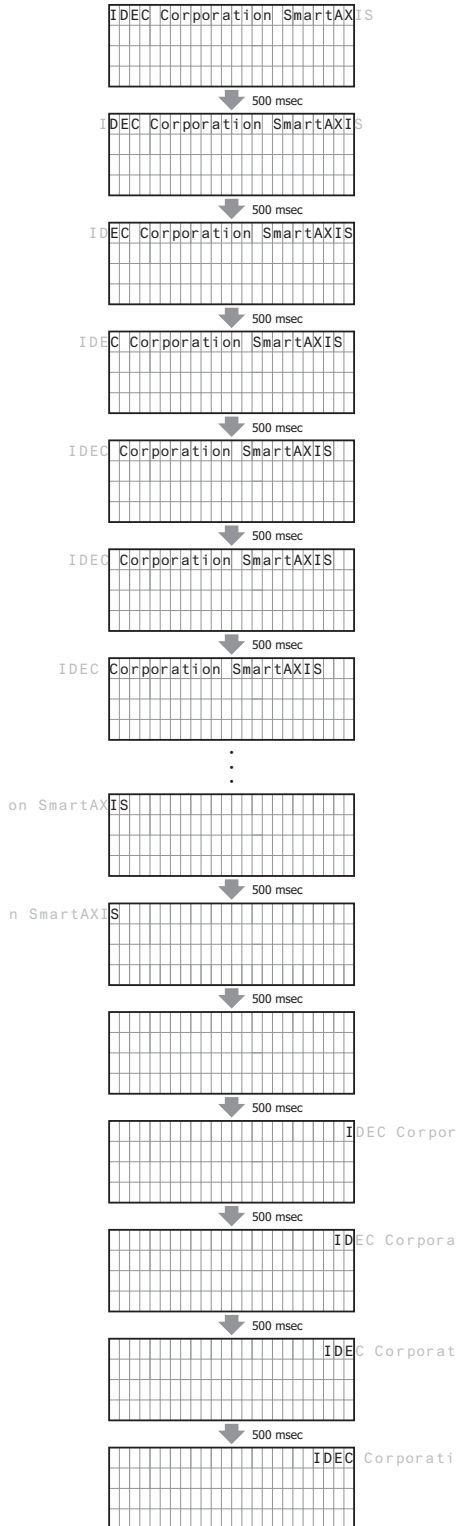

When scrolling a text shorter than or equal to the specified area on the LCD

Text: "IDEC Corp. SmartAXIS"

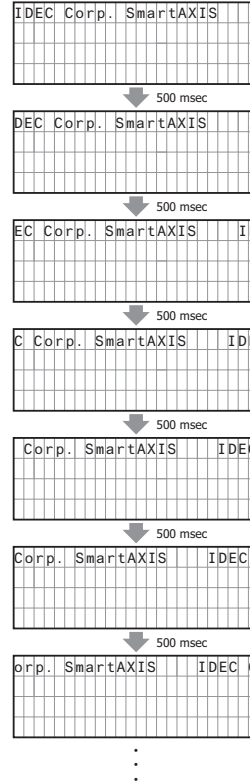

13: DISPLAY INSTRUCTIONS

[Character Set: European, Scroll speed: 500 ms, Scroll unit: 1-dot]

When a text with effect is set to scroll, the text is displayed on the LCD of the SmartAXIS as follows.

Text: "IDEC Corporation SmartAXIS"

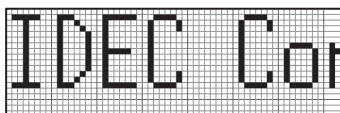
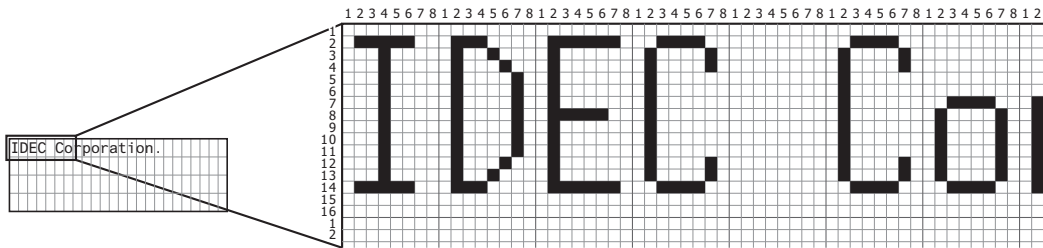

62.5 msec

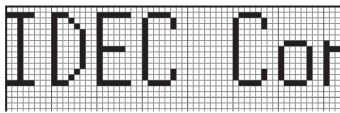

62.5 msec

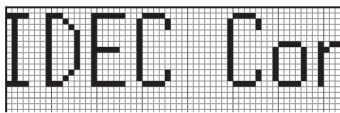

62.5 msec

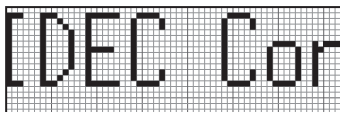

62.5 msec

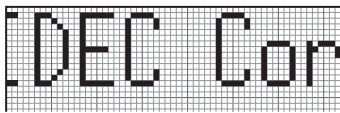

62.5 msec

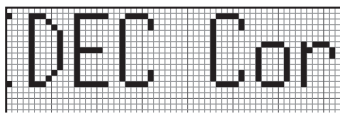

62.5 msec

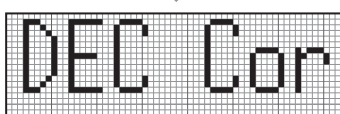

62.5 msec

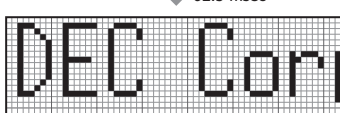

62.5 msec

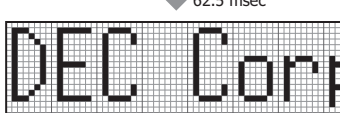

62.5 msec

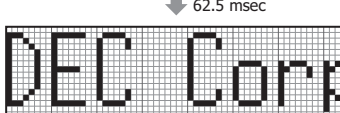

1 character (8 dots) is scrolled in 500 ms

14: PROGRAM BRANCHING INSTRUCTIONS

Introduction

The program branching instructions reduce execution time by making it possible to bypass portions of the program whenever certain conditions are not satisfied.

The basic program branching instructions are LABEL and LJM, which are used to tag an address and jump to the address which has been tagged. Programming tools include "either/or" options between numerous portions of a program and the ability to call one of several subroutines which return execution to where the normal program stopped.

LABEL (Label)

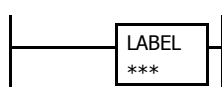

This is the label number, from 0 to 255, used at the program address where the execution of program instructions begins for a program branch.

An END instruction may be used to separate a tagged portion of the program from the main program. In this way, scan time is minimized by *not* executing the program branch unless input conditions are satisfied.

Note: A single label number cannot be used more than once.

Applicable SmartAXIS

| FT1A-12 | FT1A-24 | FT1A-40 | FT1A-40 | FT1A-Touch |
|---------|---------|---------|---------|------------|
| X | X | X | X | X |

Valid Devices

| Device | Function | I | Q | M | R | T | C | D | Constant | Repeat |
|--------------|----------------------|---|---|---|---|---|---|---|----------|--------|
| Label number | Tag for LJM and LCAL | — | — | — | — | — | — | — | 0-255 | — |

LJM (Label Jump)

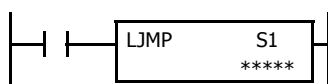

When input is on, jump to the address with label 0 through 255 assigned by S1.

When input is off, no jump takes place, and program execution proceeds with the next instruction.

The LJM instruction is used as an "either/or" choice between two portions of a program. Program execution does *not* return to the instruction following the LJM instruction, after the program branch.

Applicable SmartAXIS

| FT1A-12 | FT1A-24 | FT1A-40 | FT1A-48 | FT1A-Touch |
|---------|---------|---------|---------|------------|
| X | X | X | X | X |

Valid Devices

| Device | Function | I | Q | M | R | T | C | D | Constant | Repeat |
|---------------|--------------|---|---|---|---|---|---|---|----------|--------|
| S1 (Source 1) | Label number | — | — | — | — | — | — | X | 0-255 | — |

For valid device address ranges, see "Device Addresses" on page 3-1.

Since the LJM instruction is executed in each scan while input is on, a pulse input from a SOTU or SOTD instruction should be used.

Note: Make sure that a LABEL instruction of the label number used for a LJM instruction is programmed. When designating S1 using other than a constant, the value for the label is a variable. When using a variable for a label, make sure that all probable LABEL numbers are included in the user program. If a matching label does not exist, a user program execution error will result, turning on special internal relay M8004 and the ERR LED on the SmartAXIS. For details about the user program execution errors, see "User Program Execution Errors" on page 4-13.

14: PROGRAM BRANCHING INSTRUCTIONS

Example: LJM and LABEL

The following example demonstrates a program that jumps to three different portions of the program depending on the input.

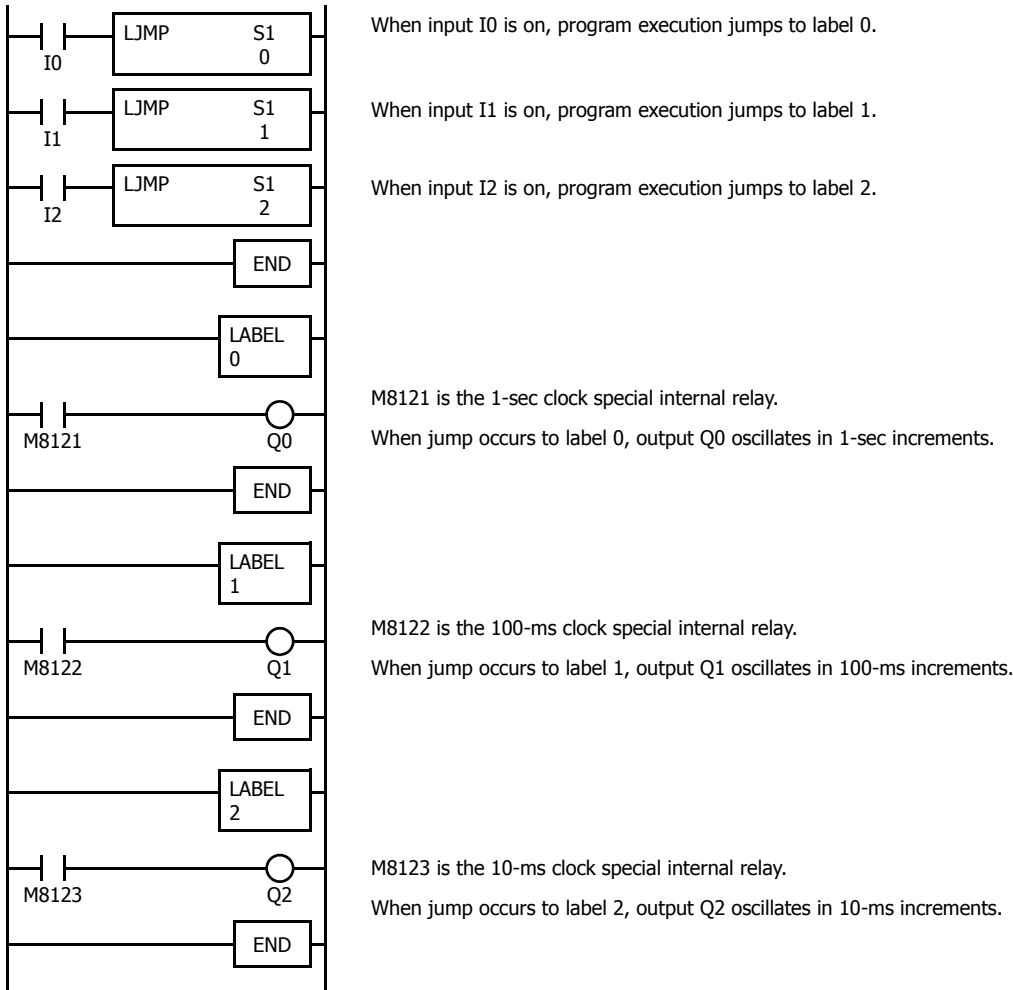

Using the Timer Instruction with Program Branching

When the timer start input of the TML, TIM, TMH or TMS instruction is already on, countdown begins immediately at the location jumped to, starting with the timer current value. When using a program branch, it is important to make sure that timers are initialized when desired, after the jump. If it is necessary to initialize the timer instruction (set to the preset value) after the jump, the timer's start input should be kept off for one or more scan cycles before initialization. Otherwise, the timer input on will not be recognized.

Using the SOTU/SOTD Instructions with Program Branching

Check that pulse inputs of counters and shift registers, and inputs of single outputs (SOTU and SOTD) are maintained during the jump, if required. Hold the input off for one or more scan cycles after the jump for the rising or falling edge transition to be recognized.

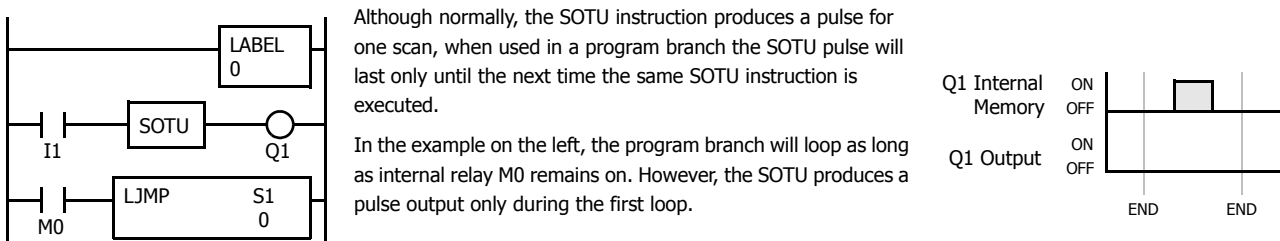

Since the END instruction is not executed as long as M0 remains on, output Q1 is not turned on even if input I1 is on.

LCAL (Label Call)

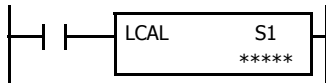

When input is on, the address with label 0 through 255 assigned by S1 is called. When input is off, no call takes place, and program execution proceeds with the next instruction.

The LCAL instruction calls a subroutine, and returns to the main program after the branch is executed. A LRET instruction (see below) must be placed at the end of a program branch which is called, so that normal program execution resumes by returning to the instruction following the LCAL instruction.

Note: The END instruction must be used to separate the main program from any subroutines called by the LCAL instruction.

A maximum of four LCAL instructions can be nested. When more than four LCAL instructions are nested, a user program execution error will result, turning on special internal relay M8004 and the ERR LED on the SmartAXIS.

Applicable SmartAXIS

| FT1A-12 | FT1A-24 | FT1A-40 | FT1A-48 | FT1A-Touch |
|---------|---------|---------|---------|------------|
| X | X | X | X | X |

Valid Devices

| Device | Function | I | Q | M | R | T | C | D | Constant | Repeat |
|---------------|----------------------|---|---|---|---|---|---|---|----------|--------|
| S1 (Source 1) | Label number to call | — | — | — | — | — | — | X | 0-255 | — |

For valid device address ranges, see "Device Addresses" on page 3-1.

Since the LCAL instruction is executed in each scan while input is on, a pulse input from a SOTU or SOTD instruction should be used.

Note: Make sure that a LABEL instruction of the label number used for a LCAL instruction is programmed. When designating S1 using other than a constant, the value for the label is a variable. When using a variable for a label, make sure that all probable LABEL numbers are included in the user program. If a matching label does not exist, a user program execution error will result, turning on special internal relay M8004 and the ERR LED on the SmartAXIS.

LRET (Label Return)

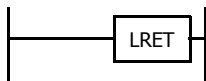

This instruction is placed at the end of a subroutine called by the LCAL instruction. When the subroutine is completed, normal program execution resumes by returning to the instruction following the LCAL instruction.

The LRET must be placed at the end of the subroutine starting with a LABEL instruction. When the LRET is programmed at other places, a user program execution error will result, turning on special internal relay M8004 and the ERR LED on the SmartAXIS.

Applicable SmartAXIS

| FT1A-12 | FT1A-24 | FT1A-40 | FT1A-48 | FT1A-Touch |
|---------|---------|---------|---------|------------|
| X | X | X | X | X |

Valid Devices

| Device | Function | I | Q | M | R | T | C | D | Constant | Repeat |
|--------|----------|---|---|---|---|---|---|---|----------|--------|
| — | — | — | — | — | — | — | — | — | — | — |

14: PROGRAM BRANCHING INSTRUCTIONS

Correct Structure for Calling Subroutine

When a LCAL instruction is executed, the remaining program instructions on the same rung may not be executed upon return, if input conditions are changed by the subroutine. After the LRET instruction of a subroutine, program execution begins with the instruction following the LCAL instruction, depending on current input condition.

When instructions following a LCAL instruction must be executed after the subroutine is called, make sure the subroutine does not change input conditions unfavorably. In addition, include subsequent instructions in a new ladder line, separated from the LCAL instruction.

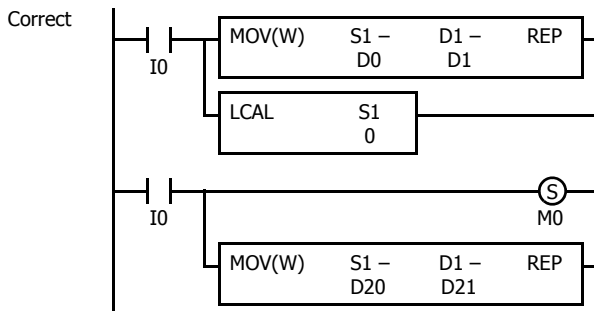

Separate the ladder line for each LCAL instruction.

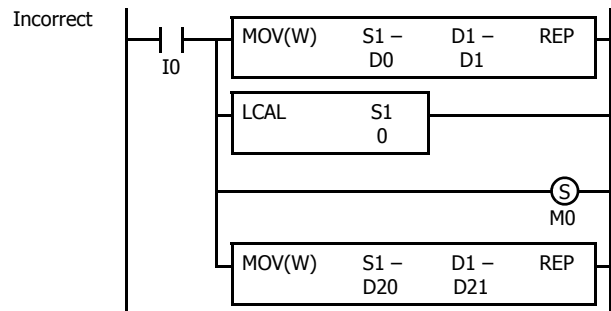

I0 status may be changed by the subroutine upon return.

Example: LCAL and LRET

The following example demonstrates a program that calls three different portions of program depending on the input. When the subroutine is complete, program execution returns to the instruction following the LCAL instruction.

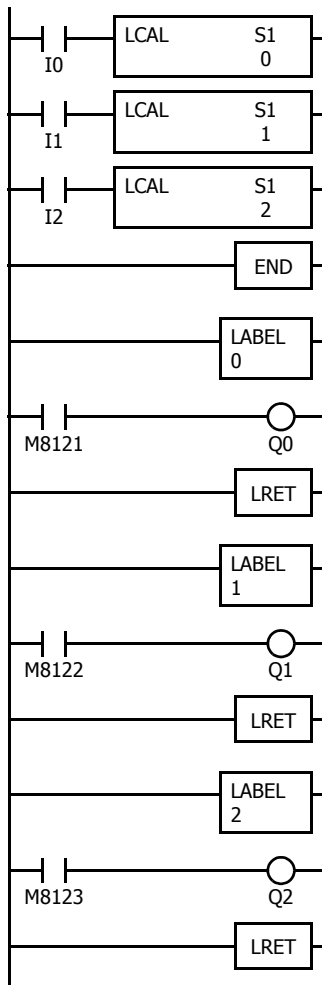

When input I0 is on, program execution jumps to label 0.

When input I1 is on, program execution jumps to label 1.

When input I2 is on, program execution jumps to label 2.

M8121 is the 1-sec clock special internal relay.

When jump occurs to label 0, output Q0 oscillates in 1-sec increments.

Program execution returns to the address of input I1.

M8122 is the 100-ms clock special internal relay.

When jump occurs to label 1, output Q1 oscillates in 100-ms increments.

Program execution returns to the address of input I2.

M8123 is the 10-ms clock special internal relay.

When jump occurs to label 2, output Q2 oscillates in 10-ms increments.

Program execution returns to the address of END.

DJNZ (Decrement Jump Non-zero)

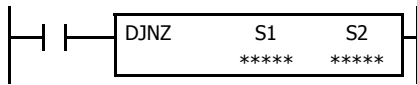

When input is on, the value stored in the data register assigned by S1 is decremented by one and is checked. If the resultant value is not 0, program execution jumps to address with label 0 through 255 assigned by S2. If the decrement results in 0, no jump takes place, and program execution proceeds with the next instruction.

Applicable SmartAXIS

| FT1A-12 | FT1A-24 | FT1A-40 | FT1A-48 | FT1A-Touch |
|---------|---------|---------|---------|------------|
| X | X | X | X | X |

Valid Devices

| Device | Function | I | Q | M | R | T | C | D | Constant | Repeat |
|---------------|-------------------------|---|---|---|---|---|---|---|----------|--------|
| S1 (Source 1) | Decrement value | — | — | — | — | — | — | X | — | — |
| S2 (Source 2) | Label number to jump to | — | — | — | — | — | — | X | 0-255 | — |

For valid device address ranges, see "Device Addresses" on page 3-1.

Since the DJNZ instruction is executed in each scan while input is on, a pulse input from a SOTU or SOTD instruction should be used.

The label number can be 0 through 255. Make sure that a LABEL instruction of the label number used for a DJNZ instruction is programmed. When designating S2 using a data register, the value for the label is a variable. When using a variable for a label, make sure that all probable LABEL numbers are included in the user program. If a matching label does not exist, a user program execution error will result, turning on special internal relay M8004 and the ERR LED on the SmartAXIS.

14: PROGRAM BRANCHING INSTRUCTIONS

Example: DJNZ and LABEL

The following example demonstrates a program to store consecutive values 1000 through 1049 to data registers D100 through D149, respectively.

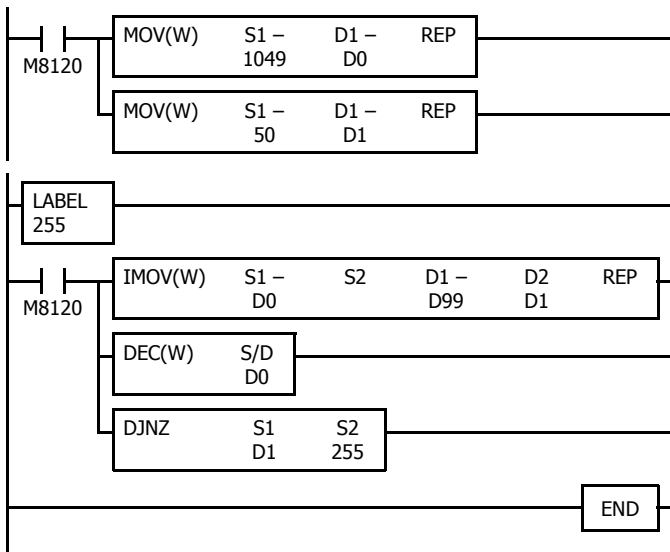

M8120 is the initialize pulse special internal relay.

At start-up, MOV instructions store initial data.

1049 → D0 to store the value for the first cycle.

50 → D1 to determine the jump cycles.

IMOV moves D0 data 1049 to D1049 in the first cycle.

DEC decrements D0 data to 1048.

DJNZ jumps to label 255 until D1 value reduces to 0.

| | | | |
|--------------------|----|---------------------------------|--------------------------------|
| 1st cycle: | D1 | <input type="text" value="50"/> | Destination: $D99 + 50 = D149$ |
| 2nd cycle: | D1 | <input type="text" value="49"/> | Destination: $D99 + 49 = D148$ |
| 3rd cycle: | D1 | <input type="text" value="48"/> | Destination: $D99 + 48 = D147$ |
| 4th cycle: | D1 | <input type="text" value="47"/> | Destination: $D99 + 47 = D146$ |
| | | ⋮ | |
| 49th cycle: | D1 | <input type="text" value="2"/> | Destination: $D99 + 2 = D101$ |
| 50th cycle: | D1 | <input type="text" value="1"/> | Destination: $D99 + 1 = D100$ |

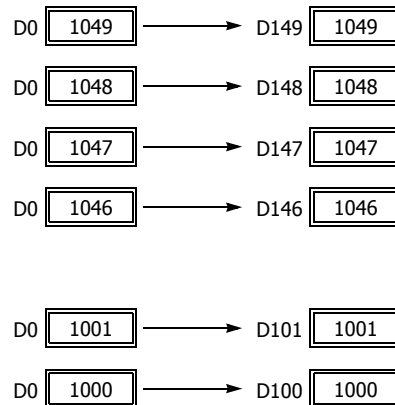

15: REFRESH INSTRUCTIONS

Introduction

This chapter describes the refresh instructions that update the status of input contacts, external output, and the current value of the high-speed counter, to the latest value during a ladder scan.

IOREF (I/O Refresh)



When input is on, 1-bit I/O data assigned by source device S1 is refreshed immediately regardless of the scan time.

When I (input) is used as S1, the actual input status is immediately read into an internal relay starting with M300 allocated to each input available on the SmartAXIS.

When Q (output) is used as S1, the output data in the RAM is immediately written to the actual output available on the SmartAXIS.

Refresh instructions are useful when a real-time response is required in a user program which has a long scan time. The refresh instruction is most effective when using the refresh instruction at a ladder step immediately before using the data.

The IOREF instruction can be used with an interrupt input or timer interrupt to refresh data.

Applicable SmartAXIS

| FT1A-12 | FT1A-24 | FT1A-40 | FT1A-48 | FT1A-Touch |
|---------|---------|---------|---------|------------|
| X | X | X | X | X |

Valid Devices

| Device | Function | I | Q | M | R | T | C | D | Constant | Repeat |
|---------------|-----------------|---|---|---|---|---|---|---|----------|--------|
| S1 (Source 1) | I/O for refresh | X | X | — | — | — | — | — | — | — |

Only input or output numbers available on the SmartAXIS can be designated as S1. Input and output numbers for remote I/O slaves cannot be designated as S1. For valid device address ranges, see "Device Addresses" on page 3-1.

Input Device Addresses and Allocated Internal Relays

Internal relays are allocated to each input device as shown in the table below. For example, when I10 is designated as S1, the latest value of I10 is set to M310.

| Input Device | Internal Relay | Input Device | Internal Relay | Input Device | Internal Relay | Input Device | Internal Relay |
|--------------|----------------|--------------|----------------|--------------|----------------|--------------|----------------|
| I0 | M300 | I10 | M310 | I20 | M320 | I30 | M330 |
| I1 | M301 | I11 | M311 | I21 | M321 | I31 | M331 |
| I2 | M302 | I12 | M312 | I22 | M322 | I32 | M332 |
| I3 | M303 | I13 | M313 | I23 | M323 | I33 | M333 |
| I4 | M304 | I14 | M314 | I24 | M324 | I34 | M334 |
| I5 | M305 | I15 | M315 | I25 | M325 | I35 | M335 |
| I6 | M306 | I16 | M316 | I26 | M326 | | |
| I7 | M307 | I17 | M317 | I27 | M327 | | |

During normal execution of a user program, I/O statuses are refreshed simultaneously when the END instruction is executed at the end of a scan. When a real-time response is needed to execute an interrupt, the IOREF instruction can be used. When the input to the IOREF instruction is turned on, the status of the designated input or output is read or written immediately.

When the IOREF instruction is executed for an input, the filter does not take effect and the input status at the moment is read to a corresponding internal relay.

The actual input status of the same input number is read to the internal input memory when the END instruction is executed as in the normal scanning, then the filter value has effect as designated in the Function Area Settings. See Chapter 5 "Special Functions" - "Input Filter" in the SmartAXIS Pro/Lite User's Manual.

15: REFRESH INSTRUCTIONS

Example: IOREF

The following example demonstrates a program that transfers the input I0 status to output Q0 using the IOREF instruction. Input I2 is designated as an interrupt input. For the interrupt input function, see Chapter 5 "Special Functions" - "Interrupt Input" in the SmartAXIS Pro/Lite User's Manual.

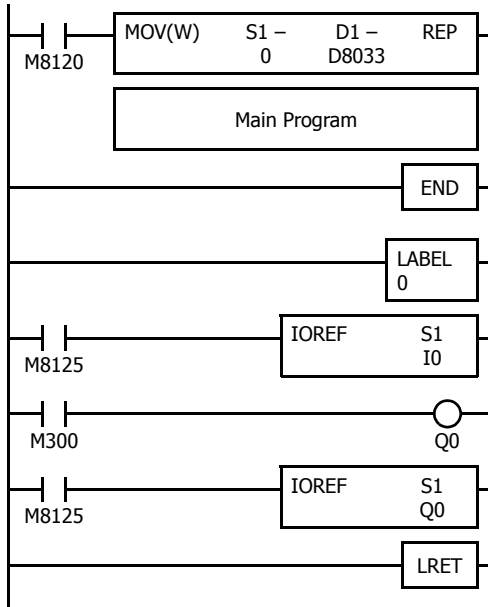

M8120 is the initialize pulse special internal relay.

D8033 stores 0 to designate jump destination label 0 for interrupt input I2.

When input I2 is on, program execution jumps to label 0.

M8125 is the in-operation output special internal relay.

IOREF immediately reads input I0 status to internal relay M300.

M300 turns on or off the output Q0 internal memory.

Another IOREF immediately writes the output Q0 internal memory status to actual output Q0.

Program execution returns to the main program.

HSCRF (High-speed Counter Refresh)

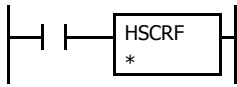

When input is on, the HSCRF instruction refreshes the high-speed counter current values in special data registers in real time.

The current values of six high-speed counters HSC1 through HSC6 are usually updated in every scan. The HSCRF can be used in any place in the ladder diagram where you want to read the updated high-speed counter current value.

For the high-speed counter function, see Chapter 5 "Special Functions" - "High-Speed Counter" in the SmartAXIS Pro/Lite User's Manual.

Applicable SmartAXIS

| FT1A-12 | FT1A-24 | FT1A-40 | FT1A-48 | FT1A-Touch |
|---------|---------|---------|---------|------------|
| X | X | X | X | X |

Example: HSCRF

The following example demonstrates a program that updates the current value of high-speed counter HSC1 using the HSCRF instruction. For the timer interrupt, see Chapter 5 "Special Functions" - "Timer Interrupt" in the SmartAXIS Pro/Lite User's Manual.

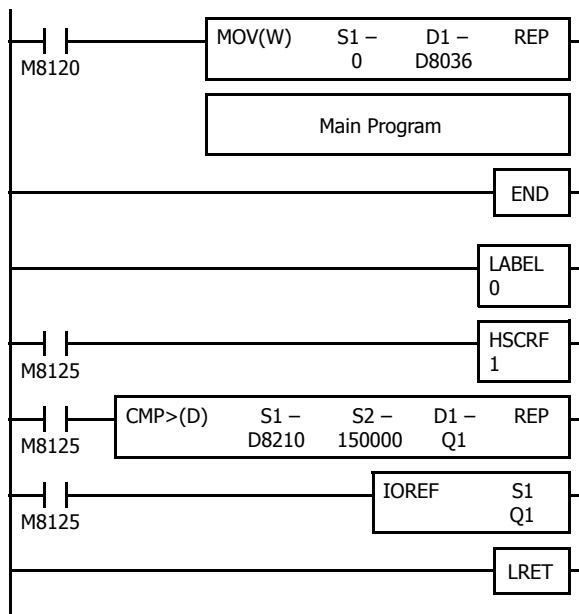

M8120 is the initialize pulse special internal relay.

D8036 stores 0 to designate jump destination label 0 for timer interrupt.

The interrupt program is separated from the main program by the END instruction.

While the CPU is running, program execution jumps to label 0 repeatedly at intervals selected in the Function Area Settings.

M8125 is the in-operation output special internal relay.

HSCRF updates the HSC1 current value in data registers D8050 and D8051.

When D8050/D8051 exceeds 150000, Q1 is turned on.

IOREF immediately writes the output Q1 internal memory status to actual output Q1.

Each time the interrupt program is completed, program execution returns to the main program at the address where timer interrupt occurred.

16: INTERRUPT CONTROL INSTRUCTIONS

Introduction

The DI or EI instruction disables or enables interrupt inputs and timer interrupt individually.

DI (Disable Interrupt)

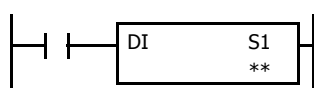

When input is on, interrupt inputs and timer interrupt assigned by source device S1 are disabled.

EI (Enable Interrupt)

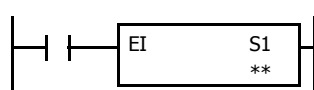

When input is on, interrupt inputs and timer interrupt assigned by source device S1 are enabled.

Applicable SmartAXIS

| FT1A-12 | FT1A-24 | FT1A-40 | FT1A-48 | FT1A-Touch |
|---------|---------|---------|---------|------------|
| X | X | X | X | X |

Valid Devices

| Device | Function | I | Q | M | R | T | C | D | Constant | Repeat |
|---------------|--------------------------------------|---|---|---|---|---|---|---|----------|--------|
| S1 (Source 1) | Interrupt inputs and timer interrupt | — | — | — | — | — | — | — | 1-127 | — |

Interrupt inputs I0 through I7 and timer interrupt selected in the Function Area Settings are normally enabled when the CPU starts. When the DI instruction is executed, interrupt inputs and timer interrupt designated as source device S1 are disabled even if the interrupt condition is met in the user program area subsequent to the DI instruction. When the EI instruction is executed, disabled interrupt inputs and timer interrupt designated as source device S1 are enabled again in the user program area subsequent to the EI instruction. Different interrupts can be selected for the DI and EI instructions to disable and enable interrupt inputs selectively. For Interrupt Input and Timer Interrupt, see Chapter 5 "Special Functions" - "Interrupt Input" and "Timer Interrupt" in the SmartAXIS Pro/Lite User's Manual.

Make sure that interrupt inputs and timer interrupt designated as source device S1 are selected in the Function Area Settings. Otherwise, when the DI or EI instruction is executed, a user program execution error will result, turning on special internal relay M8004 and the ERR LED on the SmartAXIS.

The DI and EI instructions cannot be used in an interrupt program. If used, a user program execution error will result, turning on special internal relay M8004 and the ERR LED on the SmartAXIS. For details about the user program execution errors, see "User Program Execution Errors" on page 4-13.

Special Internal Relays M8070-M8075 and M8144: Interrupt Status

Special internal relays M8070 through M8075 and M8144 are provided to indicate whether interrupt inputs and timer interrupt are enabled or disabled.

| Interrupt (Lite/Pro/Touch) | Interrupt Enabled | Interrupt Disabled |
|----------------------------|-------------------|--------------------|
| Group 1 (I0/-) | M8070 ON | M8070 OFF |
| Group 2 (I2/I2) | M8071 ON | M8071 OFF |
| Group 3 (I3/I3) | M8072 ON | M8072 OFF |
| Group 4 (I5/I4) | M8073 ON | M8073 OFF |
| Group 5 (I6/I5) | M8074 ON | M8074 OFF |
| Group 6 (I7/-) | M8075 ON | M8075 OFF |
| Timer Interrupt | M8144 ON | M8144 OFF |

Programming WindLDR

In the Disable Interrupt (DI) or Enable Interrupt (EI) dialog box, select the check box on the left of Interrupt Groups 1 through 6 or Timer Interrupt to select source device S1. The example below selects interrupt groups 2, 3, and timer interrupt for the DI instruction, and a 22 will be shown as source device S1.

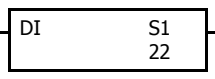
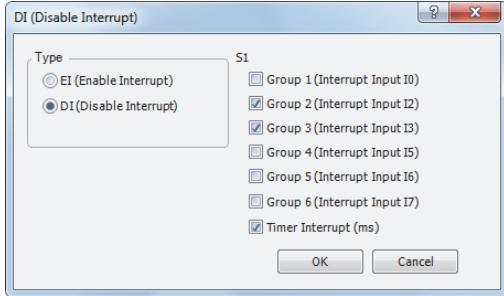

The total of selected interrupt inputs and timer interrupt is shown as source device S1.

| Interrupt (Lite/Pro/Touch) | S1 Value |
|----------------------------|----------|
| Group 1 (I0/-) | 0 |
| Group 2 (I2/I2) | 2 |
| Group 3 (I3/I3) | 4 |
| Group 4 (I5/I4) | 8 |
| Group 5 (I6/I5) | 32 |
| Group 6 (I7/-) | 64 |
| Timer Interrupt | 16 |

Example: DI and EI

The following example demonstrates a program that will disable and enable interrupt inputs and timer interrupt selectively. For the interrupt input and timer interrupt functions, see Chapter 5 "Special Functions" - "Interrupt Input" and "Timer Interrupt" in the SmartAXIS Pro/Lite User's Manual. In this example, inputs I2 and I3 are designated as interrupt inputs and timer interrupt is used with interrupt intervals of 100 ms.

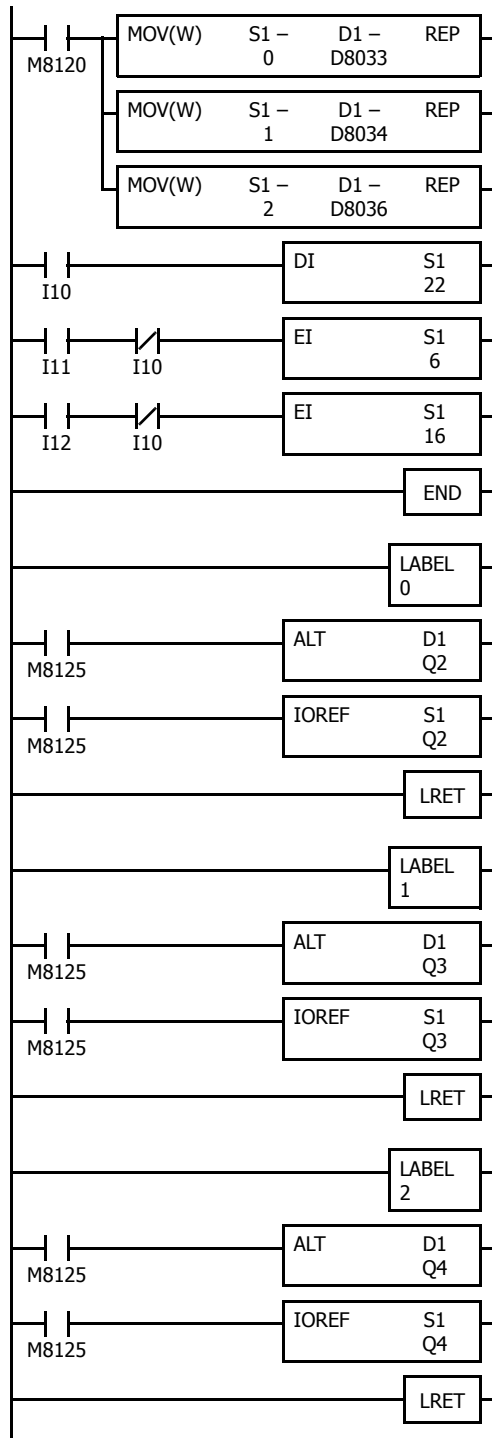

M8120 is the initialize pulse special internal relay.

D8033 stores jump destination label number 0 for interrupt input I2.

D8034 stores jump destination label number 1 for interrupt input I3.

D8036 stores jump destination label number 2 for timer interrupt.

When input I10 is on, DI disables interrupt inputs I2, I3, and timer interrupt, then M8071, M8072, and M8144 turn off.

When input I11 is on and I10 is off, EI enables interrupt inputs I2 and I3, then M8071 and M8072 turn on.

When input I12 is on and I10 is off, EI enables timer interrupt, then M8144 turns on.

End of the main program.

When input I2 is on, program execution jumps to label 0.

M8125 is the in-operation output special internal relay.

ALT turns on or off the output Q2 internal memory.

IOREF immediately writes the output Q2 internal memory status to actual output Q2.

Program execution returns to the main program.

When input I3 is on, program execution jumps to label 1.

M8125 is the in-operation output special internal relay.

ALT turns on or off the output Q3 internal memory.

IOREF immediately writes the output Q3 internal memory status to actual output Q3.

Program execution returns to the main program.

Timer interrupt occurs every 100 ms, then program execution jumps to label 2.

M8125 is the in-operation output special internal relay.

ALT turns on or off the output Q4 internal memory.

IOREF immediately writes the output Q4 internal memory status to actual output Q4.

Program execution returns to the main program.

17: COORDINATE CONVERSION INSTRUCTIONS

Introduction

The coordinate conversion instructions convert one data point to another value, using a linear relationship between values of X and Y.

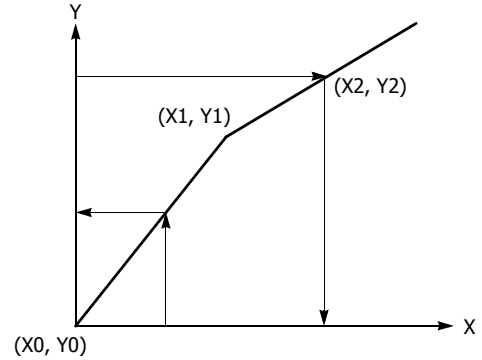

XYFS (XY Format Set)

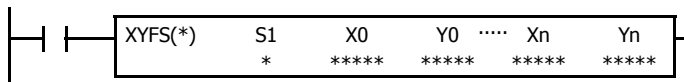

When input is on, the format for XY conversion is set. The XY coordinates define the linear relationship between X and Y.

| No. of XY Coordinates | n |
|-----------------------|--------------------|
| 2 to 32 | $0 \leq n \leq 31$ |

Applicable SmartAXIS

| FT1A-12 | FT1A-24 | FT1A-40 | FT1A-48 | FT1A-Touch |
|---------|---------|---------|---------|------------|
| X | X | X | X | X |

Valid Devices

| Device | Function | I | Q | M | R | T | C | D | Constant | Repeat |
|---------------|---------------|---|---|---|---|---|---|---|-------------------------------|--------|
| S1 (Source 1) | Format number | — | — | — | — | — | — | — | 0 to 7 | — |
| X0 through Xn | X value | X | X | X | X | X | X | X | 0 to 65535 | — |
| Y0 through Yn | Y value | X | X | X | X | X | X | X | 0 to 65535 -32768 to 32767 | — |

For valid device address ranges, see "Device Addresses" on page 3-1.

When T (timer) or C (counter) is used as X0 through Xn or Y0 through Yn, the timer/counter current value (TC or CC) is displayed.

S1 (Format number)

Select a format number 0 through 7. A maximum of 8 formats for XY conversion can be set.

Xn (X value), Yn (Y value)

Enter values for the X and Y coordinates. Two different data ranges are available depending on the data type.

| Data Type | Word | Integer |
|--------------|------------|-----------------|
| Xn (X value) | 0 to 65535 | 0 to 65535 |
| Yn (Y value) | 0 to 65535 | -32768 to 32767 |

17: COORDINATE CONVERSION INSTRUCTIONS

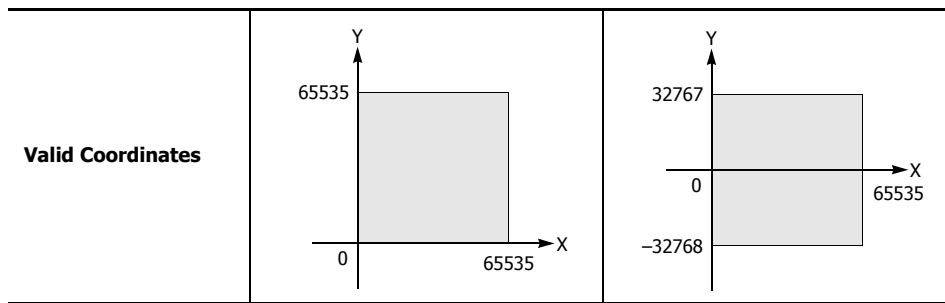

Valid Data Types

| | | |
|------------------------|---|---|
| W (word) | X | When a bit device such as I (input), Q (output), M (internal relay), or R (shift register) is assigned as Xn or Yn, 16 points are used. |
| I (integer) | X | |
| D (double word) | — | When a word device such as T (timer), C (counter), or D (data register) is assigned as Xn or Yn, 1 point is used. |
| L (long) | — | |
| F (float) | — | |

Note: The XYFS instruction cannot be used in an interrupt program.

If used, a user program execution error will result, turning on special internal relay M8004 and the ERR LED on the SmartAXIS. For details about the user program execution errors, see "User Program Execution Errors" on page 4-13.

CVXTY (Convert X to Y)

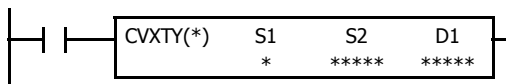

When input is on, the X value assigned by device S2 is converted into the corresponding Y value according to the linear relationship defined in the XYFS instruction. Device S1 selects a format from a maximum of 8 XY conversion formats. The conversion result is set to the device assigned by D1.

Applicable SmartAXIS

| FT1A-12 | FT1A-24 | FT1A-40 | FT1A-48 | FT1A-Touch |
|---------|---------|---------|---------|------------|
| X | X | X | X | X |

Valid Devices

| Device | Function | I | Q | M | R | T | C | D | Constant | Repeat |
|--------------------|------------------------------|---|---|---|---|---|---|---|------------|--------|
| S1 (Source 1) | Format number | — | — | — | — | — | — | — | 0 to 7 | — |
| S2 (Source 2) | X value | X | X | X | X | X | X | X | 0 to 65535 | — |
| D1 (Destination 1) | Destination to store results | — | X | ▲ | X | X | X | X | — | — |

For valid device address ranges, see "Device Addresses" on page 3-1.

▲ Internal relays M0 through M1277 can be designated as D1. Special internal relays cannot be designated as D1.

When T (timer) or C (counter) is used as S2, the timer/counter current value (TC or CC) is displayed. When T (timer) or C (counter) is used as D1, the data is written in as a preset value (TP or CP) which can be 0 through 65535.

S1 (Format number)

Select a format number 0 through 7 which have been set using the XYFS instruction. When an XYFS instruction with the corresponding format number is not programmed, or when XYFS and CVXTY instructions of the same format number have different data type designations, a user program execution error will result, turning on special internal relay M8004 and the ERR LED on the SmartAXIS. For details about the user program execution errors, see "User Program Execution Errors" on page 4-13.

S2 (X value)

Enter a value for the X coordinate to convert, within the range specified in the XYFS instruction.

D1 (Destination to store results)

The conversion result of the Y value is stored to the destination.

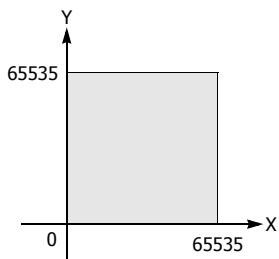
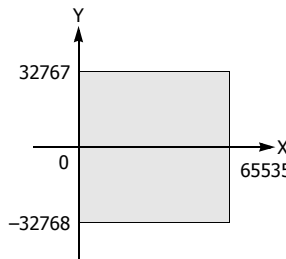
| | | |
|--------------------------|---|--|
| Data Type | Word | Integer |
| S2 (X value) | 0 to 65535 | 0 to 65535 |
| D1 (Y value) | 0 to 65535 | -32768 to 32767 |
| Valid Coordinates |  |  |

Valid Data Types

| | | |
|------------------------|---|---|
| W (word) | X | When a bit device such as I (input), Q (output), M (internal relay), or R (shift register) is assigned as S2 or D1, 16 points are used. |
| I (integer) | X | |
| D (double word) | — | When a word device such as T (timer), C (counter), or D (data register) is assigned as S2 or D1, 1 point is used. |
| L (long) | — | |
| F (float) | — | |

Data Conversion Error

The data conversion error is ±0.5.

Note: The CVXTY instruction cannot be used in an interrupt program.

If used, a user program execution error will result, turning on special internal relay M8004 and the ERR LED on the SmartAXIS. For details about the user program execution errors, see "User Program Execution Errors" on page 4-13.

CVYTX (Convert Y to X)

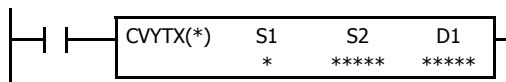

When input is on, the Y value assigned by device S2 is converted into the corresponding X value according to the linear relationship defined in the XYFS instruction. Device S1 selects a format from a maximum of 8 XY conversion formats. The conversion result is set to the device assigned by D1.

Applicable SmartAXIS

| | | | | |
|----------------|----------------|----------------|----------------|-------------------|
| FT1A-12 | FT1A-24 | FT1A-40 | FT1A-48 | FT1A-Touch |
| X | X | X | X | X |

Valid Devices

| Device | Function | I | Q | M | R | T | C | D | Constant | Repeat |
|--------------------|------------------------------|---|---|---|---|---|---|---|-------------------------------|--------|
| S1 (Source 1) | Format number | — | — | — | — | — | — | — | 0 to 7 | — |
| S2 (Source 2) | Y value | X | X | X | X | X | X | X | 0 to 65535 -32768 to 32767 | — |
| D1 (Destination 1) | Destination to store results | — | X | ▲ | X | X | X | X | — | — |

For valid device address ranges, see "Device Addresses" on page 3-1.

▲ Internal relays M0 through M1277 can be designated as D1. Special internal relays cannot be designated as D1.

When T (timer) or C (counter) is used as S2, the timer/counter current value (TC or CC) is displayed. When T (timer) or C (counter) is used as D1, the data is written in as a preset value (TP or CP) which can be 0 through 65535.

S1 (Format number)

Select a format number 0 through 7 which have been set using the XYFS instruction. When an XYFS instruction with the corresponding format number is not programmed, or when XYFS and CVYTX instructions of the same format number have different data type designations, a user program execution error will result, turning on special internal relay M8004 and the ERR LED on the SmartAXIS. For details about the user program execution errors, see "User Program Execution Errors" on page 4-13.

S2 (Y value)

Enter a value for the Y coordinate to convert, within the range specified in the XYFS instruction. Two different data ranges are available depending on the data type.

17: COORDINATE CONVERSION INSTRUCTIONS

D1 (Destination to store results)

The conversion result of the X value is stored to the destination.

| Data Type | Word | Integer |
|--------------------------|------------|-----------------|
| S2 (Y value) | 0 to 65535 | -32768 to 32767 |
| D1 (X value) | 0 to 65535 | 0 to 65535 |
| Valid Coordinates | | |

Valid Data Types

| | | |
|------------------------|---|---|
| W (word) | X | When a bit device such as I (input), Q (output), M (internal relay), or R (shift register) is assigned as S2 or D1, 16 points are used. |
| I (integer) | X | |
| D (double word) | — | When a word device such as T (timer), C (counter), or D (data register) is assigned as S2 or D1, 1 point (integer data) is used. |
| L (long) | — | |
| F (float) | — | |

Data Conversion Error

The data conversion error is ± 0.5 .

Note: The CVYTX instruction cannot be used in an interrupt program.

If used, a user program execution error will result, turning on special internal relay M8004 and the ERR LED on the SmartAXIS. For details about the user program execution errors, see "User Program Execution Errors" on page 4-13.

Example: Linear Conversion

The following example demonstrates setting up two coordinate points to define the linear relationship between X and Y. The two points are (X0, Y0) = (0, 0) and (X1, Y1) = (8000, 4000). Once these are set, there is an X to Y conversion, as well as a Y to X conversion.

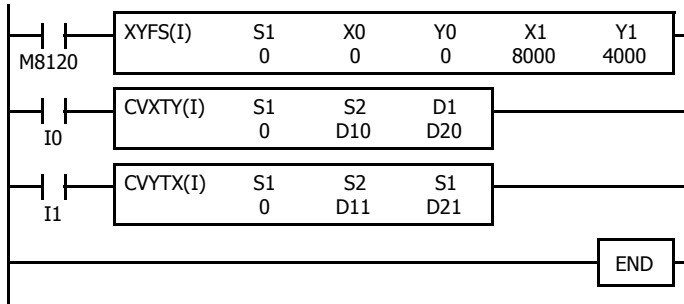

M8120 is the initialize pulse special internal relay.

At startup, XYFS specifies two points.

When input I0 is on, CVXTY converts the value in D10 and stores the result in D20.

When input I1 is on, CVYTX converts the value in D11 and stores the result in D21.

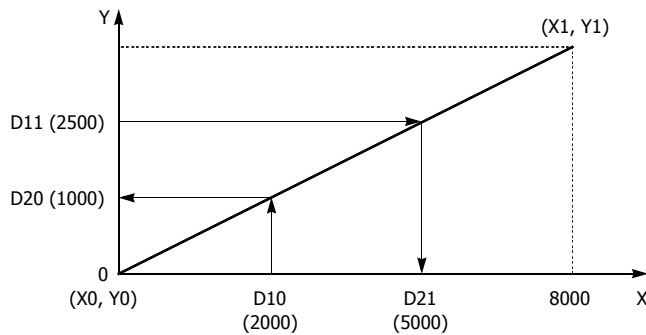

The graph shows the linear relationship that is defined by the two points:

$$Y = \frac{1}{2}X$$

If the value in data register D10 is 2000, the value assigned to D20 is 1000.

For Y to X conversion, the following equation is used:

$$X = 2Y$$

If the value in data register D11 is 2500, the value assigned to D21 is 5000.

17: COORDINATE CONVERSION INSTRUCTIONS

Example: Overlapping Coordinates

In this example, the XYFS instruction sets up three coordinate points, which define two different linear relationships between X and Y. The three points are: $(X_0, Y_0) = (0, 100)$, $(X_1, Y_1) = (100, 0)$, and $(X_2, Y_2) = (300, 100)$. The two line segments define overlapping coordinates for X. That is, for each value of Y within the designated range, there would be two X values assigned.

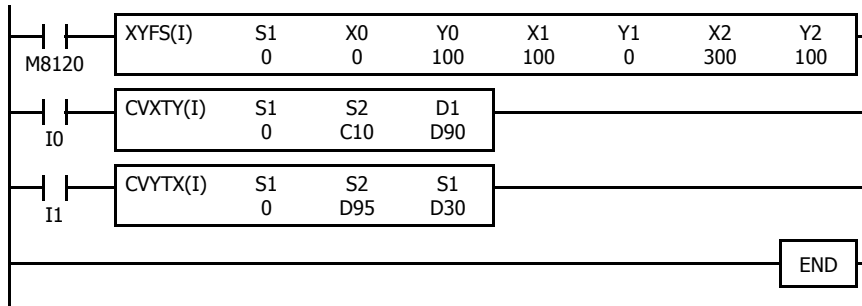

M8120 is the initialize pulse special internal relay.

At startup, XYFS specifies three points.

CVXTY converts the current value in C10 and stores the result in D90.

CVYTX converts the value in D95 and stores the result in D30.

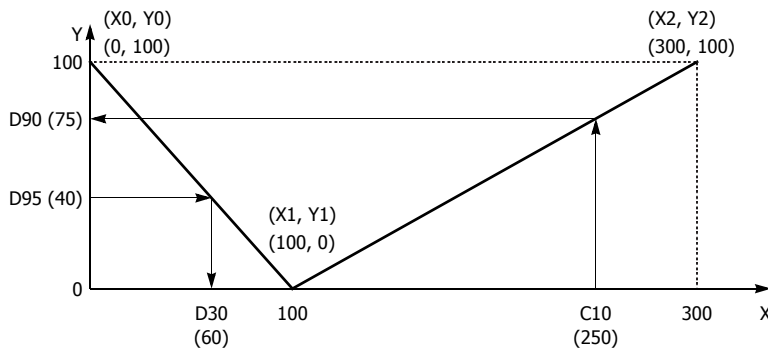

The first line segment defines the following relationship for X to Y conversion:

$$Y = -X + 100$$

The second line segment defines another relationship for X to Y conversion:

$$Y = \frac{1}{2}X - 50$$

For X to Y conversion, each value of X has only one corresponding value for Y. If the current value of counter C10 is 250, the value assigned to D90 is 75.

For Y to X conversion, the XYFS instruction assigns two possible values of X for each value of Y. The relationship defined by the first two points has priority in these cases. The line between points (X_0, Y_0) and (X_1, Y_1) , that is, the line between $(0, 100)$ and $(100, 0)$, has priority in defining the relationship for Y to X conversion ($X = -Y + 100$).

Therefore, if the value in data register D95 is 40, the value assigned to D30 is 60, not 180.

Exactly the same two line segments might also be defined by the XYFS instruction, except that the point $(300, 100)$ could be assigned first, as (X_0, Y_0) , and the point $(100, 0)$ could be defined next, as (X_1, Y_1) . In this case, this linear relationship would have priority.

In this case, if the value in data register D95 is 40, the value assigned to D30 is 180, not 60.

18: AVERAGE INSTRUCTIONS

Introduction

Average instructions average the specified data.

AVRG (Average)

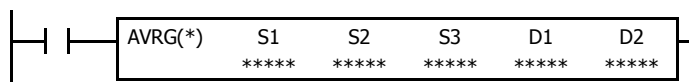

When input is on, sampling data assigned by device S1 is processed according to sampling conditions assigned by devices S2 and S3.

When sampling is complete, average, maximum, and minimum values are stored to 3 consecutive devices starting with device assigned by D1, then sampling completion output assigned by device D2 is turned on.

| Data Type | W, I | D, L, F |
|---------------|------|-----------|
| Average | D1 | D1·D1+1 |
| Maximum value | D1+1 | D1+2·D1+3 |
| Minimum value | D1+2 | D1+4·D1+5 |

The AVRG instruction is effective for data processing of analog input values. A maximum of eight AVRG instructions can be programmed in a user program.

Applicable SmartAXIS

| FT1A-12 | FT1A-24 | FT1A-40 | FT1A-48 | FT1A-Touch |
|---------|---------|---------|---------|------------|
| X | X | X | X | X |

Valid Devices

| Device | Function | I | Q | M | R | T | C | D | Constant | Repeat |
|--------------------|---------------------------------------|---|---|---|---|---|---|---|----------|--------|
| S1 (Source 1) | Sampling data | X | X | X | X | X | X | X | — | — |
| S2 (Source 2) | Sampling end input | X | X | X | X | — | — | — | — | — |
| S3 (Source 3) | Sampling cycles (scan times) | X | X | X | X | X | X | X | 0-65535 | — |
| D1 (Destination 1) | First device address to store results | — | — | — | — | — | — | X | — | — |
| D2 (Destination 2) | Sampling completion output | — | X | ▲ | — | — | — | — | — | — |

For valid device address ranges, see "Device Addresses" on page 3-1.

▲ Internal relays M0 through M1277 can be designated as D2. Special internal relays cannot be designated as D2.

When T (timer) or C (counter) is used as S1 or S3, the timer/counter current value (TC or CC) is displayed.

When F (float) data is selected, only data registers can be designated as S1 and D1.

While input is on, the AVRG instruction is executed in each scan. When the quantity of sampling cycles (scan times) designated by device S3 is 1 through 65535, sampling data designated by device S1 is processed in each scan. When the designated sampling cycles have been completed, the average value of the sampling data is set to the device designated by D1 (data type W or I) or D1·D1+1 (data type D, L, or F). The maximum value of the sampling data is set to the next device, D1+1 (data type W or I) or D1+2·D1+3 (data type D, L, or F). The minimum value of the sampling data is set to the next device, D1+2 (data type W or I) or D1+4·D1+5 (data type D, L, or F). The sampling completion output designated by device D2 is turned on.

When the quantity of sampling cycles designated by device S3 is 0, sampling is started when the input to the AVRG instruction is turned on, and stopped when the sampling end input designated by device S2 is turned on. Then, the average, maximum, and minimum values are set to 3 devices starting with device designated by D1.

When the sampling exceeds 65535 cycles, the average, maximum, and minimum values at this point are set to 3 devices starting with device designated by D1, and sampling continues.

When the sampling end input is turned on before the sampling cycles designated by device S3 have been completed, sampling is stopped and the results at this point are set to 3 devices starting with device designated by D1.

The average value is calculated to units, rounding the fractions of one decimal place.

When the sampling end input is not used, designate an internal relay or another valid device as a dummy for source device S2.

When F (float) data is selected and S1 does not comply with the normal floating-point format, a user program execution error will result, turning on special internal relay M8004 and ERR LED on the SmartAXIS. When an error occurs, incorrect S1 data are skipped. Average, maximum, and minimum values are calculated from correct S1 data, and set to 3 devices starting with the device designated by D1. For details about user program execution errors, see "User Program Execution Errors" on page 4-13.

18: AVERAGE INSTRUCTIONS

Valid Data Types

| | | |
|------------------------|---|--|
| W (word) | X | When a bit device such as I (input), Q (output), M (internal relay), or R (shift register) is assigned as the source, 16 points (word or integer data) or 32 points (double-word or long data) are used. |
| I (integer) | X | |
| D (double word) | X | |
| L (long) | X | When a word device such as T (timer), C (counter), or D (data register) is assigned as the source, 1 point (word or integer data) or 2 points (double-word, long, or float data) are used. |
| F (float) | X | |

Example: AVRG

The following example demonstrates a program that calculates the average values of data register D100 and store the result to data register D200 every 500 scans.

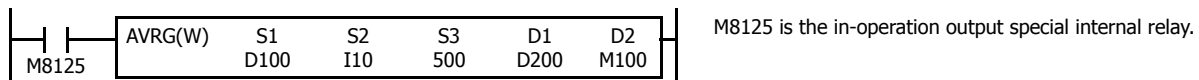

When the sampling end input does not turn on

While sampling end input I10 is off, the average, maximum, and minimum values are calculated every 500 scans and stored to data registers D200, D201, and D202, respectively. Sampling completion output M100 is set every 500 scans.

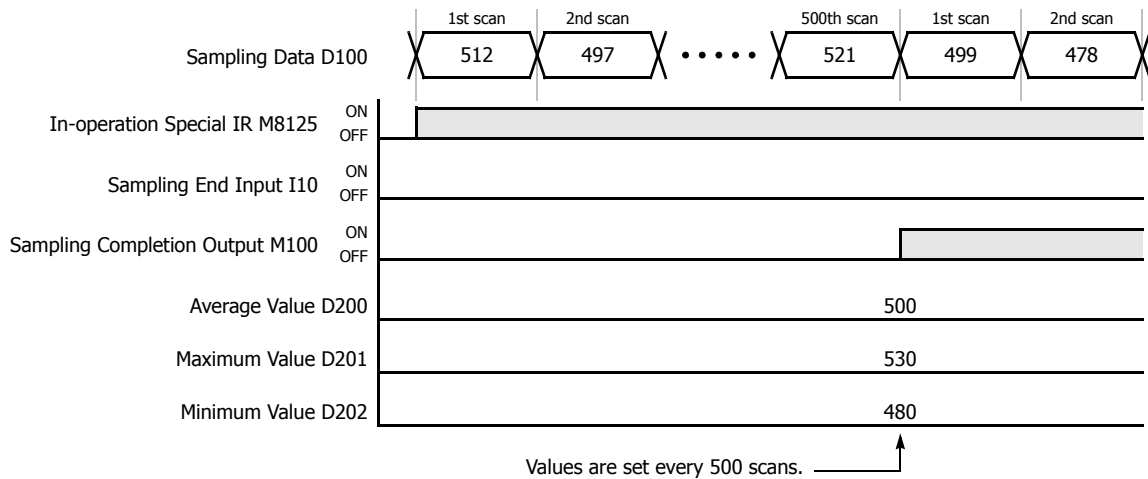

When the sampling end input turns on

When sampling end input I10 turns on, the average, maximum, and minimum values at this point are stored to data registers D200, D201, and D202, respectively. Sampling completion output M100 is also set. When sampling end input I10 turns off, sampling resumes starting at the first scan.

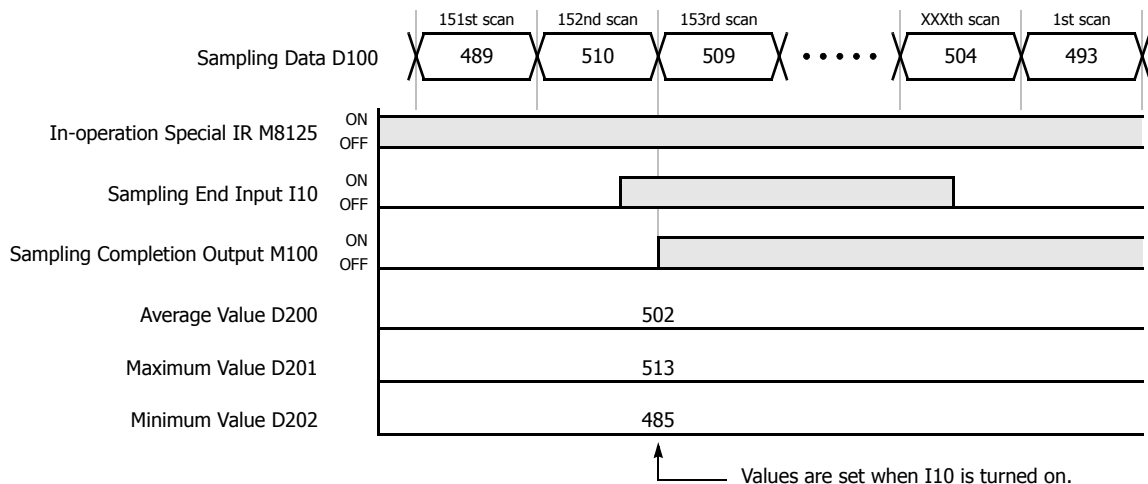

19: PULSE OUTPUT INSTRUCTIONS

Introduction

The pulse output instructions output pulses of a specified frequency. These pulses will be generated from the pulse output ports.

PULS (Pulse Output)

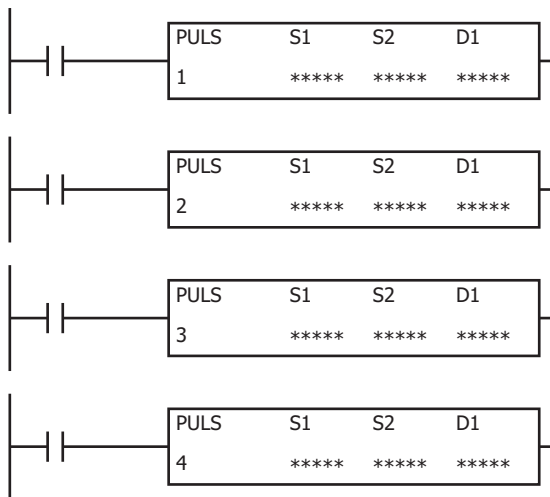

The PULS instructions output pulses of a specified frequency from the specified pulse output ports.

When input is on, pulses are output according to the control register settings specified by S1.

The pulse control information (output on/output complete/error) is stored in the internal relays specified by D1 as the operation status.

When the initialization input specified by S2 is turned on, the initial values configured in the WinLDR PULS instruction dialog box, on the **Setting** tab, are stored in the control registers.

Note: Configure multiple PULS (pulse output), PWM (pulse width modulation), RAMP (trapezoidal control), and ARAMP (RAMP with table) instructions so that they do not share the same pulse output port.

However, the ZRN (zero return) instruction can be configured with the same pulse output port as the PULS (pulse output), PWM (pulse width modulation), RAMP (trapezoidal control), and ARAMP (RAMP with table) instructions.

Note: The PULS instruction cannot be used in an interrupt program.

If used, a user program execution error will result, turning on special internal relay M8004 and the ERR LED on the SmartAXIS. For details about the user program execution errors, see "User Program Execution Errors" on page 4-13.

Applicable SmartAXIS

| FT1A-12 | FT1A-24 | FT1A-40 | FT1A-48 | FT1A-Touch |
|---------|---------|----------|---------|------------|
| — | — | X (Note) | X | — |

Note: These instructions cannot be used with FT1A-H40RC and FT1A-B40RC.

Valid Devices

| Device | Function | I | Q | M | R | T | C | D | Constant | Repeat |
|--------------------|----------------------|---|---|---|---|---|---|---|----------|--------|
| S1 (Source 1) | Control register | — | — | — | — | — | ▲ | — | — | — |
| S2 (Source 2) | Initialization input | X | — | X | — | — | — | — | — | — |
| D1 (Destination 1) | Operation status | — | — | ▲ | — | — | — | — | — | — |

▲ Special data registers cannot be designated as S1. Internal relays M0 through M1277 can be designated as D1. Special internal relays cannot be designated as D1. The first digit of the internal relay number must be 0 (not 1 to 7).

Settings

• Device tab

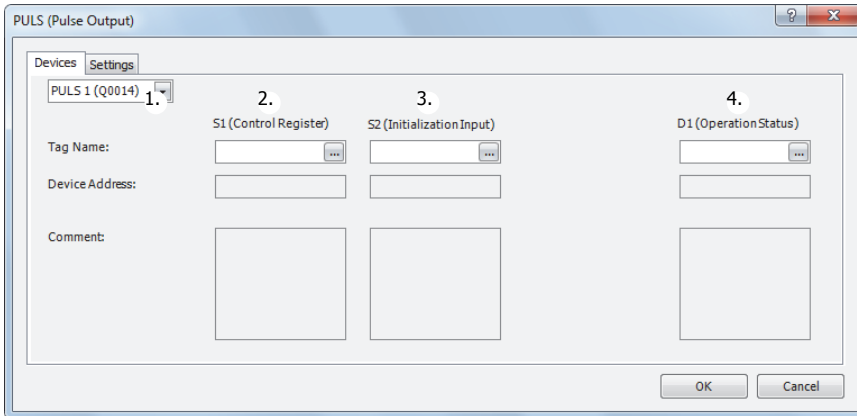

1. Select instruction

This item selects which PULS instruction to use (PULS1, PULS2, PULS3, or PULS4).

The pulse output, configurable operation modes, and enabling/disabling pulse counting varies based on the instruction.

| Instruction | Pulse output | Configurable operation mode | Enable/disable pulse counting |
|-------------|--------------|-------------------------------------|--|
| PULS1 | Q14 | Operation mode 0: 1 Hz to 10 kHz | Pulse counting can be enabled or disabled (Pulse counting range: 1 to 100,000,000) |
| PULS2 | Q15 | Operation mode 1: 200 Hz to 100 kHz | |
| PULS3 | Q16 | Operation mode 0: 1 Hz to 5 kHz | Disable pulse counting |
| PULS4 | Q17 | | |

2. S1 (source 1): Control register

S1 specifies the starting number for the data registers to use with PULS1, PULS2, PULS3, or PULS4 instructions.

Starting from the specified number, 7 consecutive 16-bit data registers are used.

The range of available data register numbers is D0 to D993 and D1000 to D1993.

| Storage destination | Function | Setting | Reference | | | | |
|---------------------|--|---|---------------------------------|--|--------------|--|--|
| Starting number+0 | Output pulse frequency | <table border="1"> <tr> <td>PULS1, PULS2</td> <td>Mode 0: 1 to 10,000 (increments of 1 Hz) Mode 1: 20 to 10,000 (increments of 10 Hz)</td> </tr> <tr> <td>PULS3, PULS4</td> <td>Mode 0: 1 to 5,000 (increments of 1 Hz) Mode 1: Cannot be specified</td> </tr> </table> | PULS1, PULS2 | Mode 0: 1 to 10,000 (increments of 1 Hz) Mode 1: 20 to 10,000 (increments of 10 Hz) | PULS3, PULS4 | Mode 0: 1 to 5,000 (increments of 1 Hz) Mode 1: Cannot be specified | "6. Output pulse frequency" on page 19-3 |
| PULS1, PULS2 | Mode 0: 1 to 10,000 (increments of 1 Hz) Mode 1: 20 to 10,000 (increments of 10 Hz) | | | | | | |
| PULS3, PULS4 | Mode 0: 1 to 5,000 (increments of 1 Hz) Mode 1: Cannot be specified | | | | | | |
| Starting number+1 | Reserved | — | — | | | | |
| Starting number+2 | Preset value (high word) (Note) | 1 to 100,000,000 pulses | "8. Preset value" on page 19-4 | | | | |
| Starting number+3 | Preset value (low word) (Note) | | | | | | |
| Starting number+4 | Current value (high word) (Note) | 1 to 100,000,000 pulses | "9. Current value" on page 19-4 | | | | |
| Starting number+5 | Current value (low word) (Note) | | | | | | |
| Starting number+6 | Error status | 0 to 4 | "10. Error status" on page 19-4 | | | | |

Note: The upper and lower data registers change according to the 32-bit data storage method specified.

For details, see Chapter 5 "Special Functions" – "32-bit Data Storage Setting" in the SmartAXIS Pro/Lite User's Manual.

3. S2 (source 2): Initialization input

S2 specifies the initialization input. When the initialization input is turned on, the initial values configured in the WindLDR PULS instruction dialog box, on the **Setting** tab, are stored in the control registers. An external input (I0 to I35) (Note) or an internal relay (M0 to M1277) can be specified.

When the initialization input is on, the initial values are written to the data registers with each scan. To only initialize the values one time, use the initialization input in combination with the SOTU (single output up) instruction or the SOTD (single output down) instruction.

Note: For the 40-I/O type, external inputs (I0 to I27) can be used.

4. D1 (destination 1): Operation status

D1 specifies the starting number of the internal relays to use with PULS instructions.

Starting from the specified internal relay, 3 sequential internal relays are used.

The range of available internal relays is M0 to M1270. The first digit of the internal relay number must be set to 0.

| Storage destination | Function | Setting | |
|---------------------|-----------------------|--|---|
| Starting number+0 | Pulse output ON | 0: Pulse output OFF 1: Pulse output ON | This relay turns on during pulse output. This relay turns off when pulse output stops. This relay turns off when the specified number of pulses are output and output ends. |
| Starting number+1 | Pulse output complete | 0: Pulse output not complete 1: Pulse output complete | This relay turns on when pulse output is complete. This relay turns off when pulse output starts. |
| Starting number+2 | Overflow | 0: None 1: An overflow has occurred | When pulse counting is enabled, this relay turns on when a pulse is output that exceeds the configured preset value. |

• **Setting tab**

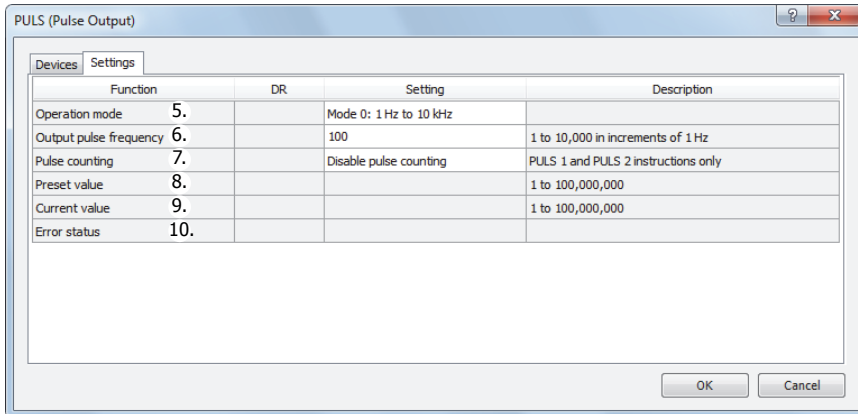

5. Operation mode

This setting selects the frequency range to output from two operation modes. Only PULS3 and PULS4 support operation mode 0.

| Operation mode | Supported instruction | | | |
|--|-----------------------|-------|-------|-------|
| | PULS1 | PULS2 | PULS3 | PULS4 |
| 0: 1 Hz to 10 kHz (increments of 1 Hz) (Note) (PULS1, PULS2) 1 Hz to 5 kHz (increments of 1 Hz) (Note) (PULS3, PULS4) | X | X | X | X |
| 1: 200 Hz to 100 kHz (increments of 10 Hz) (Note) | X | X | — | — |

Note: The output frequency error is within ±5%.

6. Output pulse frequency

PULS1, PULS2: Mode 0: Set between 1 Hz and 10 kHz in increments of 1 Hz. The output frequency error is ±5%.

Mode 1: Set between 200 Hz and 100 kHz in increments of 10 Hz. The output frequency error is ±5%.

PULS3, PULS4: Set between 1 Hz and 5 kHz in increments of 1 Hz. The output frequency error is ±5%.

19: PULSE OUTPUT INSTRUCTIONS

7. Pulse counting

This setting enables or disables pulse counting.

| Pulse counting | | Supported instruction | | | |
|---------------------------|--|-----------------------|-------|-------|-------|
| | | PULS1 | PULS2 | PULS3 | PULS4 |
| 0: Disable pulse counting | Pulses are continuously output while the input is on. | X | X | X | X |
| 1: Enable pulse counting | The number of pulses specified by the preset value are output. | X | X | — | — |

8. Preset value

When counting pulses, this setting specifies the number of pulses to output.

9. Current value

The number of pulses that were output is stored in this data register. The current value is updated when the PULS instruction is executed at each scan.

10. Error status

If a configuration error occurs when the PULS instruction input changes from off to on, M8004 (user program execution error) is turned on and this register is set to the error code.

| Error code | Status | Description | |
|------------|-----------------------------------|---|---|
| 0 | Normal | — | |
| 2 | Pulse frequency designation error | PULS1, PULS2 | The pulse frequency was not set between 1 and 10,000 in operation mode 0. The pulse frequency was not set between 20 and 10,000 in operation mode 1. |
| | | PULS3, PULS4 | The pulse frequency was not set between 1 and 5,000 in operation mode 0. |
| 4 | Preset value designation error | The preset value was not set between 1 and 100,000,000. | |

Examples: PULS

PULS1 instruction (pulse counting enabled) timing chart

[PULS1 instruction, S1 is specified as D200, D1 is specified as internal relay M50]

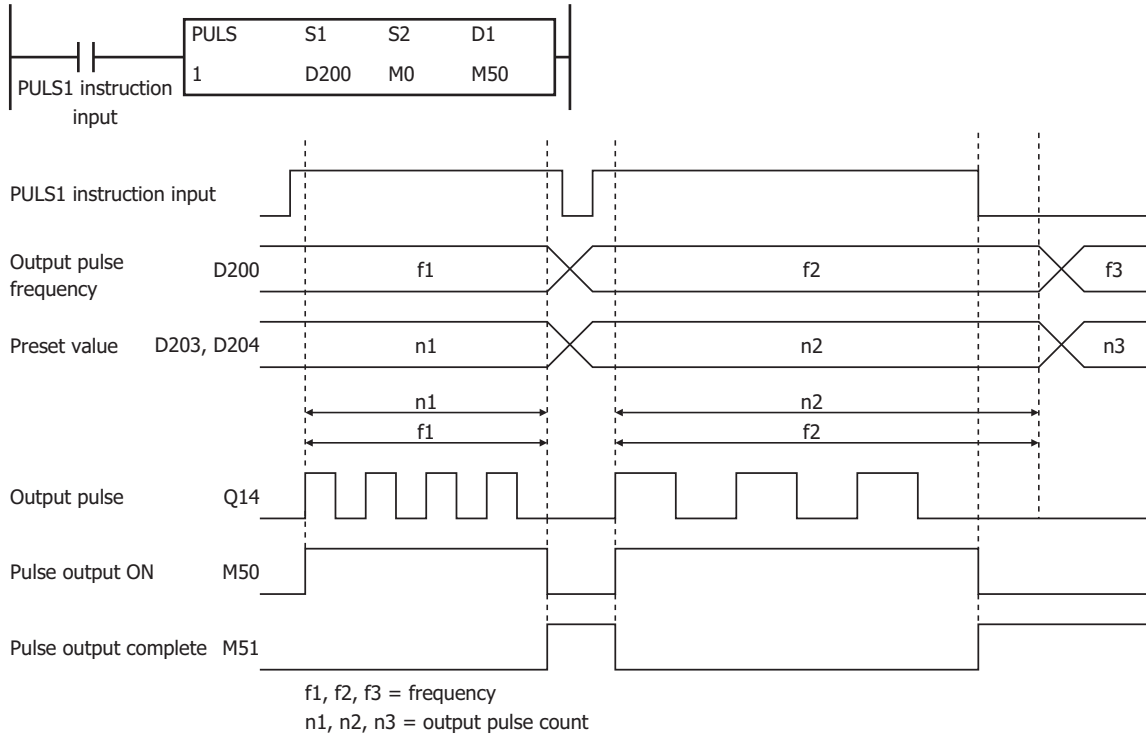

When the PULS1 instruction input changes from off to on, M50 turns on and pulses with the frequency configured by D200 are output. When the number of pulses configured by D202 and D203 are output, pulse output stops. If the value of D200 changes during pulse output, pulses are output with the frequency based on that value.

When the PULS1 instruction input changes from on to off, M50 turns off and M51 turns on at the same time.

The changes from the initialization input are not reflected while the PULS1 instruction input is on. If you wish to initialize the data registers with the initialization input, turn the initialization input on after turning off the input.

19: PULSE OUTPUT INSTRUCTIONS

PULS2 instruction (pulse counting disabled) timing chart

[PULS2 instruction, S1 is specified as D100, D1 is specified as internal relay M200]

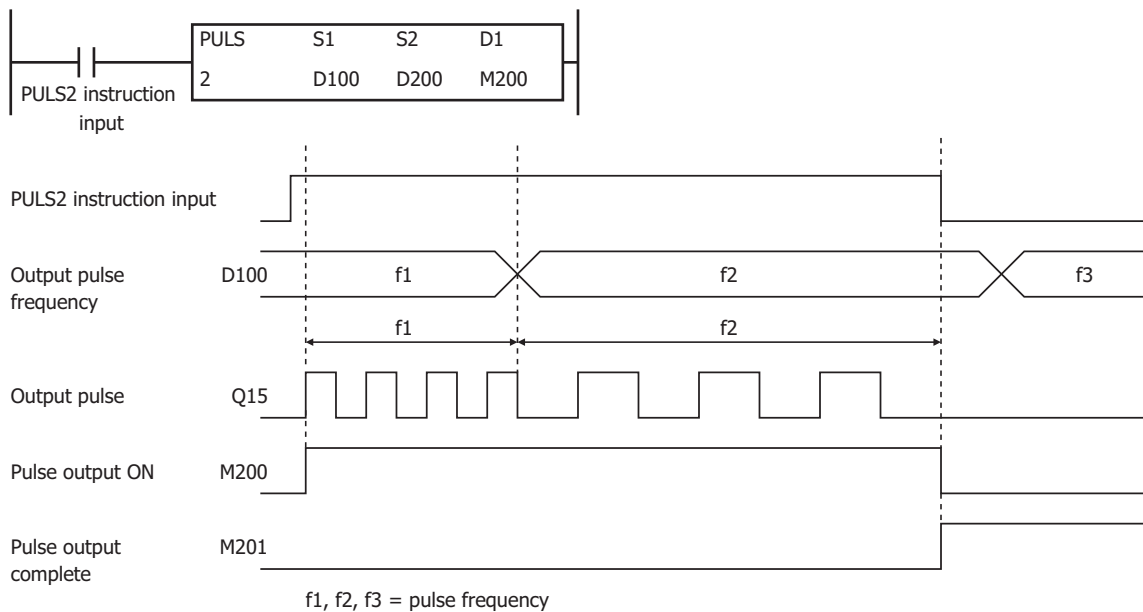

When the PULS2 instruction input changes from off to on, M200 turns on and pulses with the frequency configured by D100 are output. If the value of D100 changes during pulse output, pulses are output with the frequency based on that value.

When the PULS2 instruction input changes from on to off, M200 turns off and M201 turns on at the same time.

The changes from the initialization input are not reflected while the PULS2 instruction input is on. If you wish to initialize the data registers with the initialization input, turn the initialization input on after turning off the input.

Sample program

This section describes an example program that outputs 5,000 pulses (each at 200 Hz) and then 60,000 pulses (each at 500 Hz) from output Q14

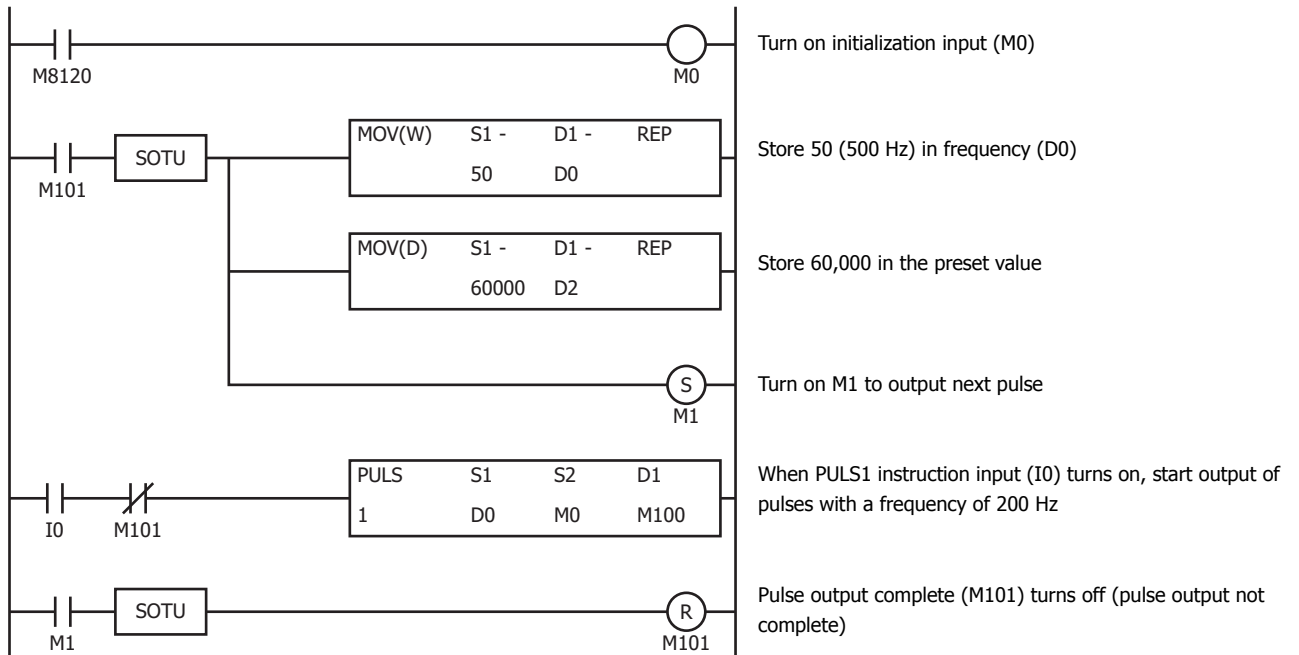

Settings

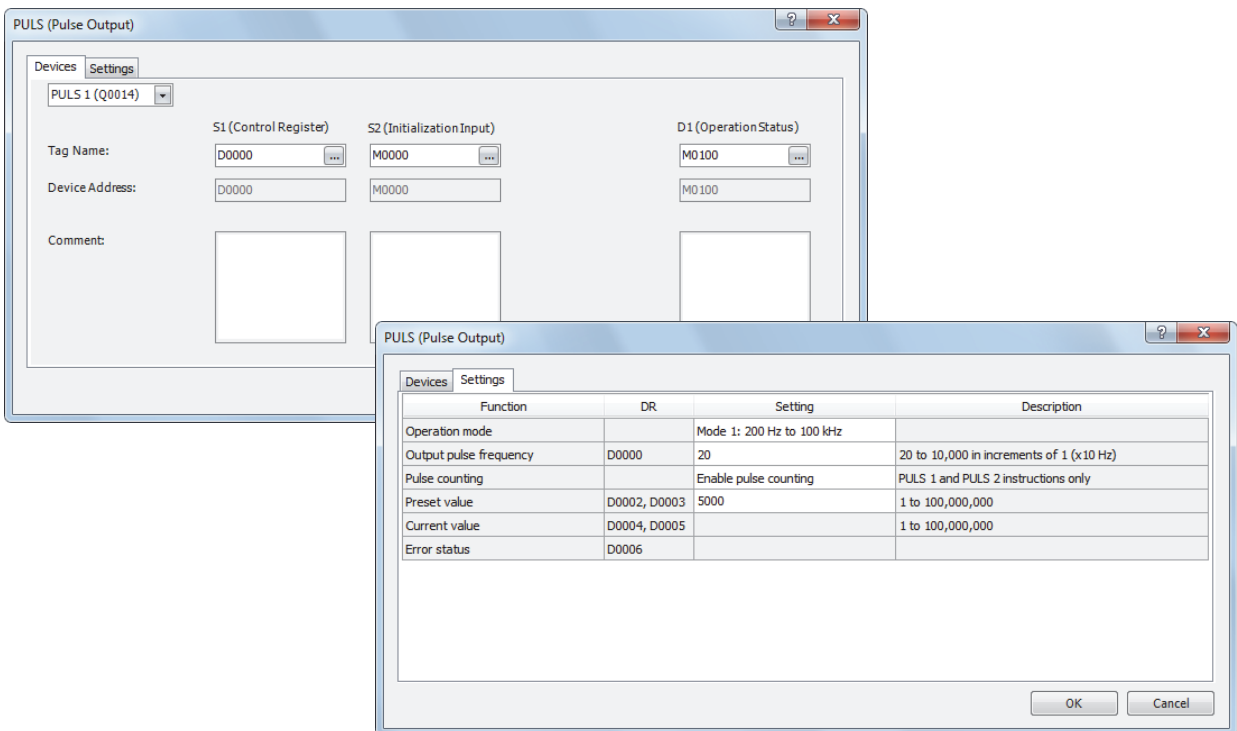

| Function | Device address | Setting value | Details |
|------------------------|----------------|-----------------------|--------------------|
| Operation mode | — | Mode 1 | 200 Hz to 100 kHz |
| Output pulse frequency | D0 | 20 | 200 Hz |
| Pulse counting | — | Enable pulse counting | — |
| Preset value | D2, D3 | 5000 | Preset value=5,000 |

PWM (Variable Duty Cycle Pulse Output)

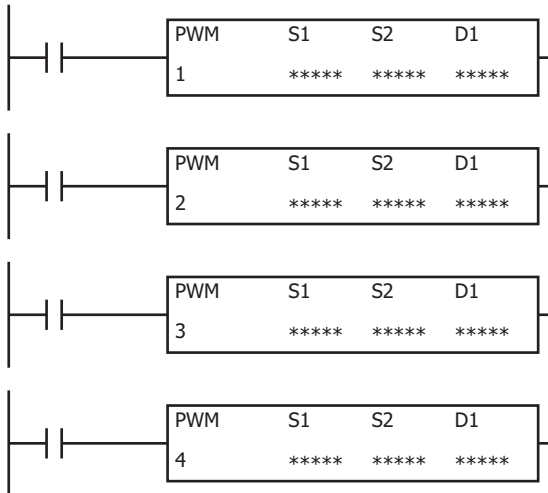

The PWM instructions output pulses at the specified frequency and duty cycle from the output port.

When the input is on, pulses are output according to the control register settings specified by S1.

The pulse control information (output on/output complete/error) is stored in the internal relays specified by D1 as the operation status.

When the initialization input specified by S2 is turned on, the initial values configured in the WindLDR PWM instruction dialog box, on the **Setting** tab, are stored in the control registers.

Note: Configure multiple PULS (pulse output), PWM (pulse width modulation), RAMP (trapezoidal control), and ARAMP (RAMP with table) instructions so that they do not share the same pulse output port.

However, the ZRN (zero return) instruction can be configured with the same pulse output port as the PULS (pulse output), PWM (pulse width modulation), RAMP (trapezoidal control), and ARAMP (RAMP with table) instructions.

Note: The PWM instruction cannot be used in an interrupt program.

If used, a user program execution error will result, turning on special internal relay M8004 and the ERR LED on the SmartAXIS. For details about the user program execution errors, see "User Program Execution Errors" on page 4-13.

Applicable SmartAXIS

| FT1A-12 | FT1A-24 | FT1A-40 | FT1A-48 | FT1A-Touch |
|---------|---------|----------|---------|------------|
| — | — | X (Note) | X | — |

Note: These instructions cannot be used with FT1A-H40RC and FT1A-B40RC.

Valid Devices

| Device | Function | I | Q | M | R | T | C | D | Constant | Repeat |
|--------------------|----------------------|---|---|---|---|---|---|---|----------|--------|
| S1 (Source 1) | Control register | — | — | — | — | — | — | ▲ | — | — |
| S2 (Source 2) | Initialization input | X | — | X | — | — | — | — | — | — |
| D1 (Destination 1) | Operation status | — | — | ▲ | — | — | — | — | — | — |

▲ Special data registers cannot be designated as S1. Internal relays M0 through M1277 can be designated as D1. Special internal relays cannot be designated as D1. The first digit of the internal relay number must be set to 0.

Settings

- **Device tab**

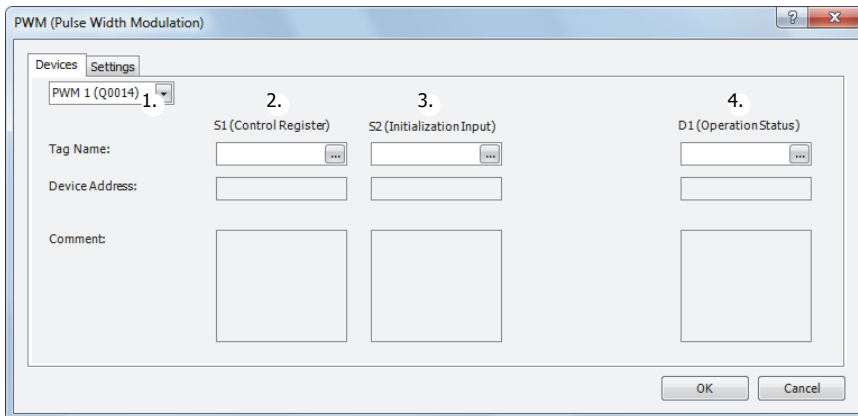

1. Select instruction

This item selects which PWM instruction to use (PWM1, PWM2, PWM3, or PWM4).

The pulse output, pulse duty cycle (ON ratio), and enabling/disabling pulse counting varies based on the instruction.

| Instruction | Pulse output | Pulse duty cycle (ON ratio) | Enable/disable pulse counting |
|-------------|--------------|---|--|
| PWM1 | Q14 | 1 to 100% (increments of 1%) | Pulse counting can be enabled or disabled (Pulse counting range: 1 to 100,000,000) |
| PWM2 | Q15 | | |
| PWM3 | Q16 | 1 to 100% (1 to 50 Hz: increments of 1%, 51 to 1,000 Hz: increments of (pulse frequency ÷ 50)%) | Disable pulse counting |
| PWM4 | Q17 | | |

2. S1 (source 1): Control register

S1 specifies the starting number for the data registers to use with PWM1, PWM2, PWM3, or PWM4 instructions.

Starting from the specified number, 7 consecutive 16-bit data registers are used.

The range of available data register numbers is D0 to D993 and D1000 to D1993.

| Storage destination | Function | Setting | Reference |
|---------------------|----------------------------------|---------------------------------|---|
| Starting number+0 | Output pulse frequency | 1 to 1,000 (increments of 1 Hz) | "5. Output pulse frequency" on page 19-10 |
| Starting number+1 | Pulse duty cycle (ON ratio) | 1 to 100% | "6. Pulse width ratio" on page 19-10 |
| Starting number+2 | Preset value (high word) (Note) | 1 to 100,000,000 pulses | "8. Preset value" on page 19-11 |
| Starting number+3 | Preset value (low word) (Note) | | |
| Starting number+4 | Current value (high word) (Note) | 1 to 100,000,000 pulses | "9. Current value" on page 19-11 |
| Starting number+5 | Current value (low word) (Note) | | |
| Starting number+6 | Error status | 0 to 4 | "10. Error status" on page 19-11 |

Note: The upper and lower data registers change according to the 32-bit data storage method specified.

For details, see Chapter 5 "Special Functions" – "32-bit Data Storage Setting" in the SmartAXIS Pro/Lite User's Manual.

3. S2 (source 2): Initialization input

S2 specifies the initialization input. When the initialization input S2 is turned on, the initial values configured in the WindLDR PWM instruction dialog box, on the **Setting** tab, are stored in the control registers. An external input (I0 to I35) (Note) or an internal relay (M0 to M1277) can be specified.

When the initialization input is on, the initial values are written to the data registers with each scan. To only initialize the values one time, use the initialization input in combination with the SOTU (single output up) instruction or the SOTD (single output down) instruction.

Note: For the 40-I/O type, external inputs (I0 to I27) can be used.

19: PULSE OUTPUT INSTRUCTIONS

4. D1 (destination 1): Operation status

D1 specifies the starting number of the internal relays to use with PWM instructions.

Starting from the specified internal relay, 3 sequential internal relays are used.

The range of available internal relay numbers is M0 to M1270. The first digit of the internal relay number must be set to 0.

| Storage destination | Function | Setting | |
|---------------------|-----------------------|--|---|
| Starting number+0 | Pulse output ON | 0: Pulse output OFF 1: Pulse output ON | This relay turns on during pulse output. This relay turns off when the PWM instruction output stops. This relay turns off when the specified number of pulses are output and output ends. |
| Starting number+1 | Pulse output complete | 0: Pulse output not complete 1: Pulse output complete | This relay turns on when pulse output is complete. This relay turns off when the PWM instruction output starts. |
| Starting number+2 | Overflow | 0: None 1: An overflow has occurred | When pulse counting is enabled, this relay turns on when a pulse is output that exceeds the configured preset value. |

• Setting tab

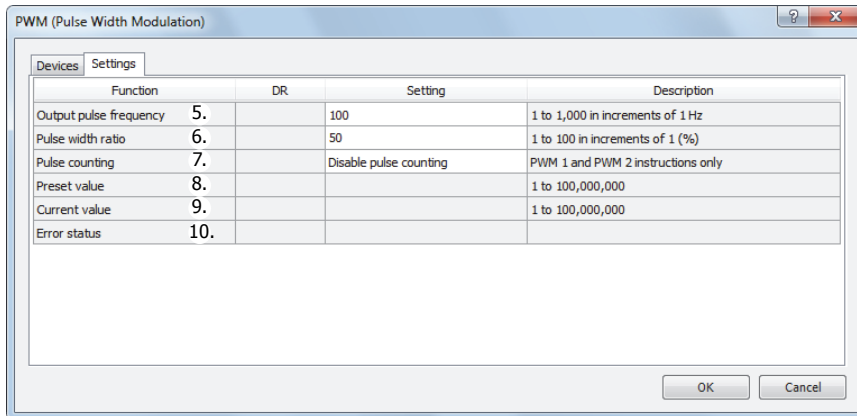

5. Output pulse frequency

This setting configures the frequency for the pulses to output from 1 Hz to 1,000 Hz in increments of 1 Hz.

The output frequency error is within $\pm 5\%$.

6. Pulse width ratio

This setting specifies the ON ratio (duty cycle) for the pulse frequency to output. The duty cycle can be set for output frequency in increments of 1%. The pulse duty cycle can be set for output frequency in increments of 1% from 1 Hz to 50 Hz, but from 51 Hz to 1,000 Hz, the increments for the pulse duty cycle that can be specified to change according to the output frequency. The increment becomes (pulse frequency \div 50)%. For example, when 51 Hz is specified for the pulse frequency, $51 \div 50 = 2$ (rounded up), so the increment is 2%. When 1,000 Hz is specified for the pulse frequency, $1000 \div 50 = 20$, so the increment is 20%. For increments of 2%, a value from 1 to 2 entered in **Pulse width ratio** is rounded up and handled as 2%, 3 to 4 is rounded up and handled as 4%. For increments of 20%, 1 to 20 is handled as 20%, 21 to 40 is handled as 40%.

7. Pulse counting

This setting enables or disables pulse counting.

| Pulse counting | | Supported instruction | | | |
|---------------------------|--|-----------------------|------|------|------|
| | | PWM1 | PWM2 | PWM3 | PWM4 |
| 0: Disable pulse counting | Pulses are continuously output while the input is on. | X | X | X | X |
| 1: Enable pulse counting | The number of pulses specified by the preset value are output. | X | X | — | — |

8. Preset value

When counting pulses, this setting specifies the number of pulses to output.

9. Current value

The number of pulses that were output is stored in this data register. The current value is updated when the PWM instruction is executed at each scan.

10. Error status

If a configuration error occurs when the PWM instruction input changes from off to on, M8004 (user program execution error) is turned on and this register is set to the error code.

| Error code | Status | Description |
|-------------------|-------------------------------------|---|
| 0 | Normal | — |
| 1 | Pulse frequency designation error | The pulse frequency was not set between 1 and 1,000. |
| 2 | Pulse width ratio designation error | The pulse width ratio was not set between 1 and 100. |
| 4 | Preset value designation error | The preset value was not set between 1 and 100,000,000. |

Examples: PWM

PWM1 instruction (pulse counting enabled) timing chart

[PWM1 instruction, S1 is specified as D200, D1 is specified as internal relay M50]

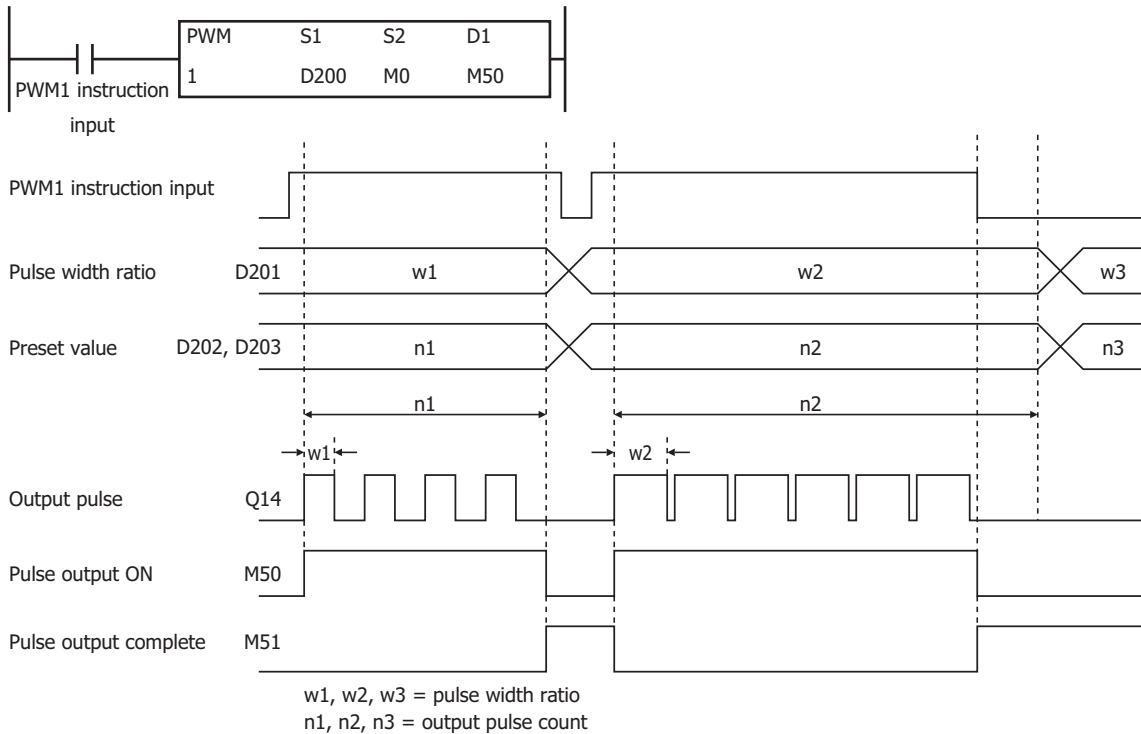

When the PWM1 instruction input changes from off to on, M50 turns on and pulses with the width ratio configured by D201 are output. When the number of pulses configured by D202 and D203 are output, pulse output stops. If the value of D201 changes during pulse output, pulses are output with the width ratio based on that value.

When the PWM1 instruction input changes from on to off, M50 turns off and M51 turns on at the same time.

The changes from the initialization input are not reflected while the PWM1 instruction input is on. If you wish to initialize the data registers with the initialization input, turn the initialization input on after turning off the input.

PWM2 instruction (pulse counting disabled) timing chart

[PWM2 instruction, S1 is specified as D100, D1 is specified as internal relay M200]

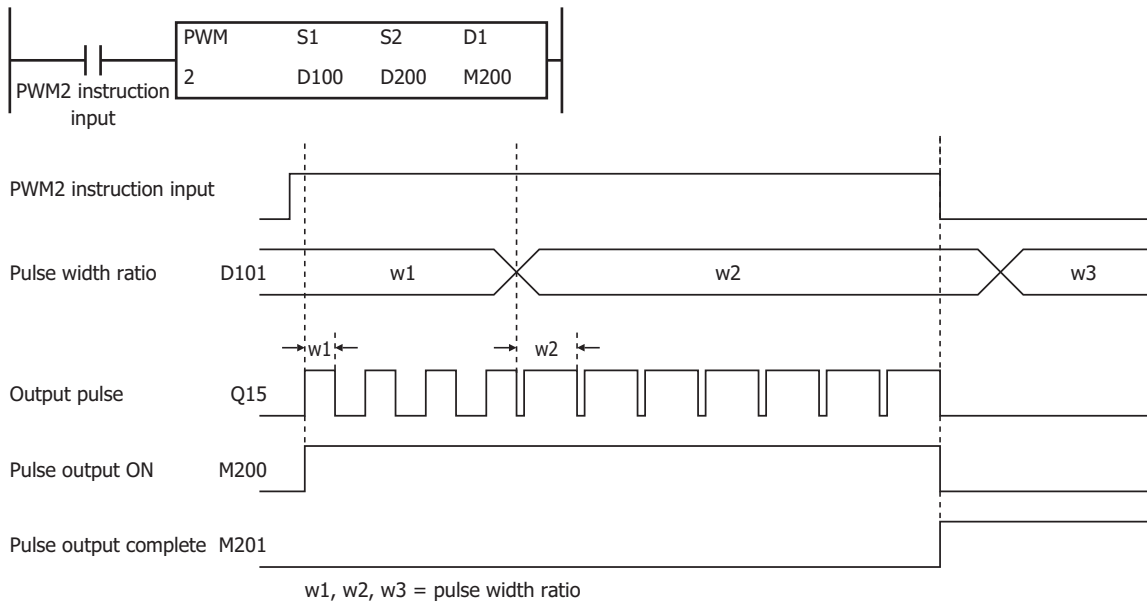

When the PWM2 instruction input changes from off to on, M200 turns on and pulses with the width ratio configured by D101 are output. If the value of D101 changes during pulse output, pulses are output with the width ratio based on that value.

When the PWM2 instruction input changes from on to off, M200 turns off and M201 turns on at the same time.

The changes from the initialization input are not reflected while the PWM2 instruction input is on. If you wish to initialize the data registers with the initialization input, turn the initialization input on after turning off the input.

19: PULSE OUTPUT INSTRUCTIONS

Sample program

This section describes an example program that outputs a pulse with the pulse width ratio of 30% when I0 is off, and a pulse with the pulse width ratio of 60% when I0 is on.

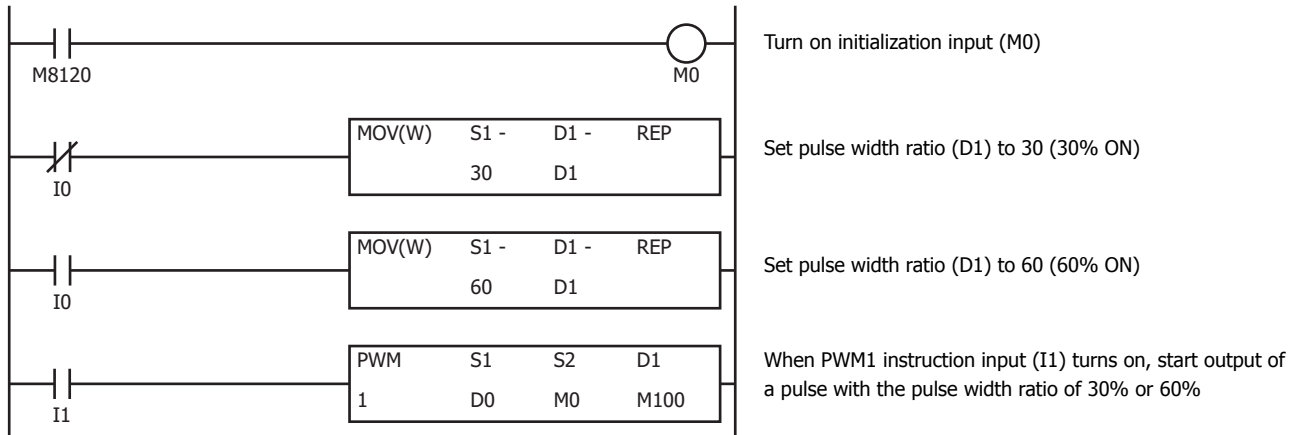

Settings

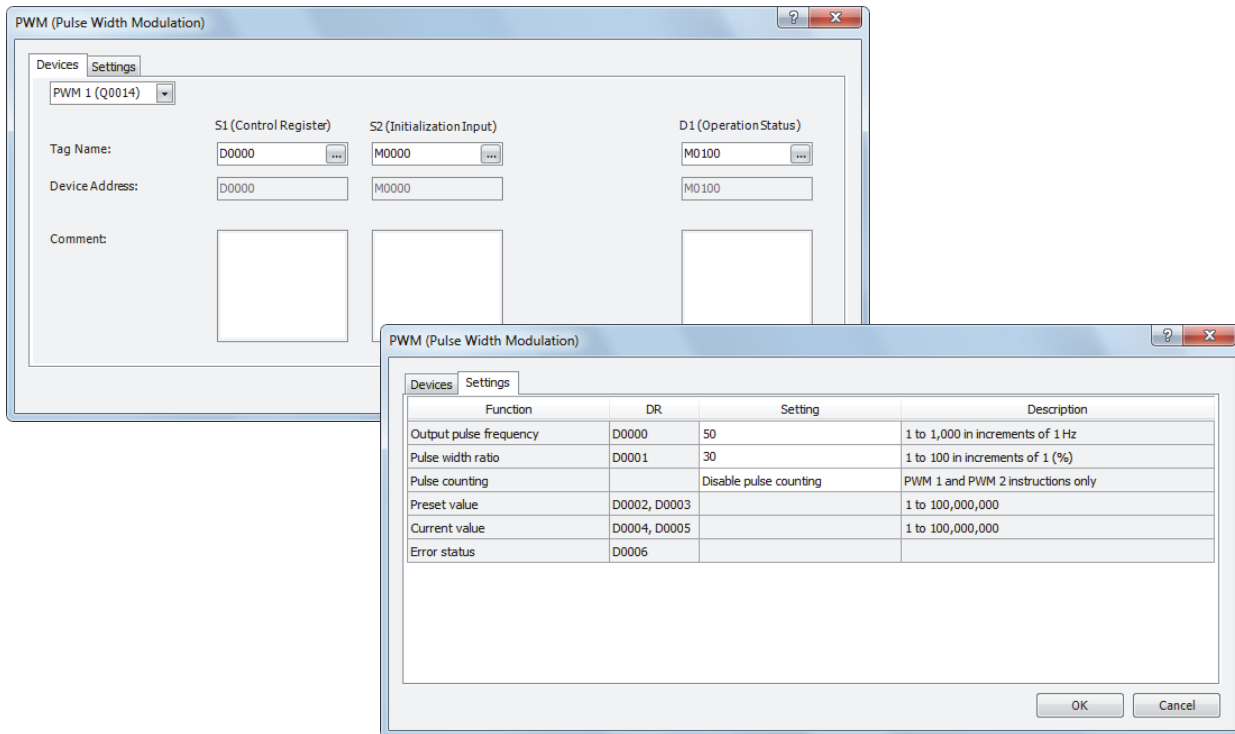

| Function | Device address | Setting value | Details |
|------------------------|----------------|------------------------|---------|
| Output pulse frequency | D0 | 50 | 50 Hz |
| Pulse width ratio | D1 | 30 | 30% |
| Pulse counting | — | Disable pulse counting | — |
| Preset value | D2, D3 | — | — |

RAMP (Trapezoidal Control)

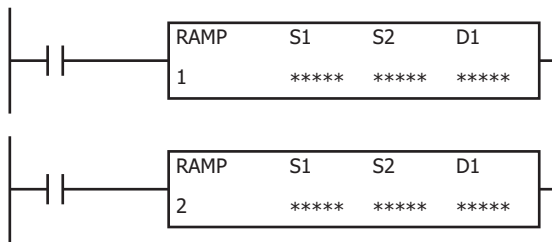

The RAMP instruction outputs pulses with a frequency change function.

When the input is on, pulses of the initial pulse frequency specified by S1 are output, and then the pulse frequency is increased by a fixed ratio until it reaches the steady pulse frequency.

After steady pulse output at the steady pulse frequency, the pulse frequency is decreased before the pulse count reaches the preset value specified by S1, and then pulse output stops when the preset value is reached.

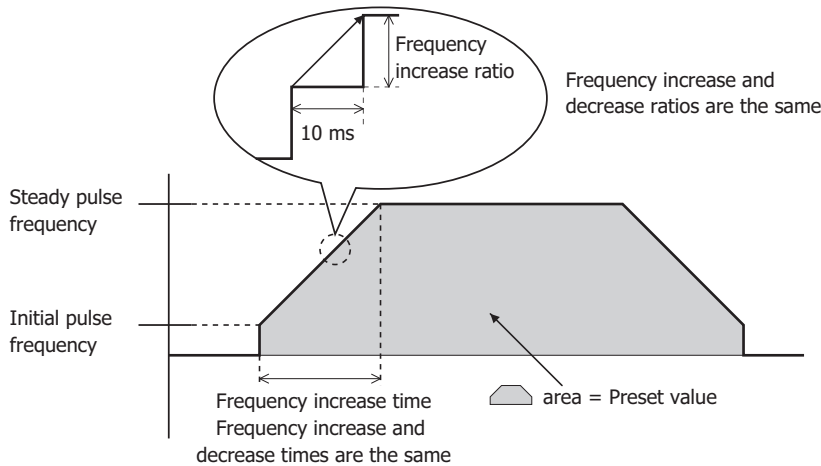

Note: Configure multiple PULS (pulse output), PWM (pulse width modulation), RAMP (trapezoidal control), and ARAMP (RAMP with table) instructions so that they do not share the same pulse output port.

However, the ZRN (zero return) instruction can be configured with the same pulse output port as the PULS (pulse output), PWM (pulse width modulation), RAMP (trapezoidal control), and ARAMP (RAMP with table) instructions.

Note: The RAMP instruction cannot be used in an interrupt program.

If used, a user program execution error will result, turning on special internal relay M8004 and the ERR LED on the SmartAXIS. For details about the user program execution errors, see "User Program Execution Errors" on page 4-13.

Applicable SmartAXIS

| FT1A-12 | FT1A-24 | FT1A-40 | FT1A-48 | FT1A-Touch |
|---------|---------|----------|---------|------------|
| — | — | X (Note) | X | — |

Note: These instructions cannot be used with FT1A-H40RC and FT1A-B40RC.

Valid Devices

| Device | Function | I | Q | M | R | T | C | D | Constant | Repeat |
|--------------------|----------------------|---|---|---|---|---|---|---|----------|--------|
| S1 (Source 1) | Control register | — | — | — | — | — | — | ▲ | — | — |
| S2 (Source 2) | Initialization input | X | — | X | — | — | — | — | — | — |
| D1 (Destination 1) | Operation status | — | — | ▲ | — | — | — | — | — | — |

▲ Special data registers cannot be designated as S1. Internal relays M0 through M1277 can be designated as D1. Special internal relays cannot be designated as D1. The first digit of the internal relay number must be set to 0.

Settings

• Device tab

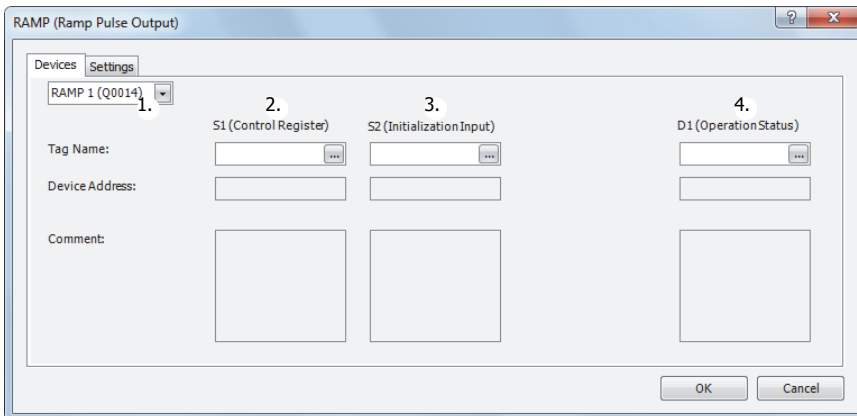

1. Select instruction

This item selects which RAMP instruction to use (RAMP1 or RAMP2).

The reversible control mode that can be selected varies based on the instruction.

For limitations based on the combination of instruction, reversible control mode, and the pulse output mode, see "9. Reversible control enable" on page 19-18.

2. S1 (source 1): Control register

S1 specifies the starting number of the data registers to use with RAMP1 or RAMP2 instructions.

Starting from the specified number, 9 consecutive 16-bit data registers are used.

The range of available data register numbers is D0 to D991 and D1000 to D1991.

| Storage destination | Function | Setting | Reference |
|---------------------|----------------------------------|--|--|
| Starting number+0 | Steady pulse frequency | Operation mode 0: 1 to 10,000 (increments of 1 Hz) Operation mode 1: 20 to 10,000 (increments of 10 Hz) | "6. Steady pulse frequency" on page 19-18 |
| Starting number+1 | Initial pulse frequency | Operation mode 0: 1 to 10,000 (increments of 1 Hz) Operation mode 1: 20 to 10,000 (increments of 10 Hz) | "7. Initial pulse frequency" on page 19-18 |
| Starting number+2 | Frequency change time | 10 to 10,000 ms | "8. Frequency change time" on page 19-18 |
| Starting number+3 | Control direction | 0: Forward 1: Reverse | "10. Control direction" on page 19-18 |
| Starting number+4 | Preset value (high word) (Note) | 1 to 100,000,000 pulses | "11. Preset value" on page 19-18 |
| Starting number+5 | Preset value (low word) (Note) | | |
| Starting number+6 | Current value (high word) (Note) | 1 to 100,000,000 pulses | "12. Current value" on page 19-19 |
| Starting number+7 | Current value (low word) (Note) | | |
| Starting number+8 | Error status | 0 to 9 | "13. Error status" on page 19-19 |

Note: The upper and lower data registers change according to the 32-bit data storage method specified.

For details, see Chapter 5 "Special Functions" – "32-bit Data Storage Setting" in the SmartAXIS Pro/Lite User's Manual.

3. S2 (source 2): Initialization input

S2 specifies the initialization input.

When the initialization input S2 is turned on, the initial values configured in the WindLDR RAMP instruction dialog box, on the **Setting** tab, are stored in the control registers.

An external input (I0 to I35) (Note) or an internal relay (M0 to M1277) can be specified.

When the initialization input is on, the initial values are written to the data registers with each scan. To only initialize the values one time, use the initialization input in combination with the SOTU (single output up) instruction or the SOTD (single output down) instruction.

Note: For the 40-I/O type, external inputs (I0 to I27) can be used.

4. D1 (destination 1): Operation status

D1 specifies the starting number of the internal relays to use with the RAMP instructions. Starting from the specified internal relay, 4 sequential internal relays are used. The range of available internal relay numbers is M0 to M1270. The first digit of the internal relay number must be set to 0.

| Storage destination | Function | Setting | |
|---------------------|-----------------------|--|---|
| Starting number+0 | Pulse output ON | 0: Pulse output OFF 1: Pulse output ON | This relay turns on during pulse output. This relay turns off when the RAMP instruction output stops. This relay turns off when the specified number of pulses are output and output ends. |
| Starting number+1 | Pulse output complete | 0: Pulse output not complete 1: Pulse output complete | This relay turns on when pulse output is complete. This relay turns off when the RAMP instruction output starts. |
| Starting number+2 | Pulse output status | 0: Steady pulse output 1: Changing output pulse frequency | This relay turns off when the pulse output status is steady. This relay turns on when the pulse output is changing. |
| Starting number+3 | Overflow | 0: None 1: An overflow has occurred | This internal relay turns on when the pulses output exceed the configured preset value. Pulse output continues even if an overflow occurs during steady output or while the pulse frequency is changing. However, pulse counting is suspended at the point when the overflow occurred. |

• Setting tab

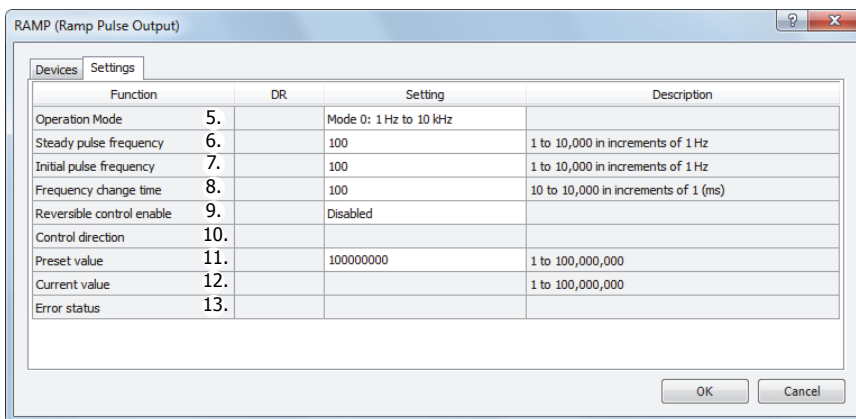

5. Operation mode

This setting selects the frequency range to output from the following operation modes. Select the operation mode according to the steady pulse frequency and the initial pulse frequency used.

| Operation mode |
|---|
| 0: 1 Hz to 10 kHz (increments of 1 Hz) (Note) |
| 1: 200 Hz to 100 kHz (increments of 10 Hz) (Note) |

Note: The output frequency error is within ±5%.

19: PULSE OUTPUT INSTRUCTIONS

6. Steady pulse frequency

This setting specifies the steady pulse frequency after the pulse frequency increases.
 For operation mode 0, set the frequency in the range of 1 to 10,000 (increments of 1 Hz).
 For operation mode 1, set the frequency in the range of 20 to 10,000 (increments of 10 Hz).

7. Initial pulse frequency

This setting specifies the frequency when pulse output starts.
 For operation mode 0, set the frequency in the range of 1 to 10,000 (increments of 1 Hz).
 For operation mode 1, set the frequency in the range of 20 to 10,000 (increments of 10 Hz).

8. Frequency change time

This setting specifies the time to increase and decrease the pulse frequency.
 Set the time between 10 and 10,000 ms in increments of 10 ms. The first digit of the setting is ignored.

9. Reversible control enable

This setting enables or disables reversible control and selects the reversible control method from the following reversible control modes.

| Reversible control enable | |
|---------------------------|--|
| 0: | Reversible control disabled |
| 1: | Reversible control (single-pulse output) |
| 2: | Reversible control (dual-pulse output) |

There are two modes for the pulse output mode: single-pulse and dual-pulse. They can be combined with reversible control as follows.

| | | |
|---|--|--|
| Reversible control disabled | Select this option when using pulse output in a single direction. Pulse A and pulse B can be used independently. | |
| Reversible control Single-pulse output mode | Pulse A is used as pulse output. Pulse B on/off is used as reversible control. | |
| Reversible control Dual-pulse output mode | Pulse A is used as forward pulse (CW) output. Pulse B is used as reverse pulse (CCW) output. | |

The ports used on the SmartAXIS vary based on the instruction used, the combination of the pulse output mode and reversible control, and the model used.

| Instruction | Operating condition | Port used | | | |
|-------------|--|-------------------|-------------------------|-------------------|-------------------------|
| | | 40-I/O type | | 48-I/O type | |
| | | Pulse output port | Reversible control port | Pulse output port | Reversible control port |
| RAMP1 | Reversible control disabled | Q14 | — | Q14 | — |
| | Reversible control (single-pulse output) | Q14 | Q16 (Note) | Q14 | Q12 |
| | Reversible control (dual-pulse output) | Q14 | Q15 | Q14 | Q15 |
| RAMP2 | Reversible control disabled | Q15 | — | Q15 | — |
| | Reversible control (single-pulse output) | Q15 | Q17 (Note) | Q15 | Q13 |
| | Dual-pulse output mode cannot be used. | — | — | — | — |

Note: When using single-pulse mode on the 40-I/O type, Q16 or Q17 are used. Therefore, PULS3, PWM3, or PULS4, PWM4 cannot be used.

10. Control direction

When reversible control is enabled, store 0 in this data register for forward operation and store 1 in this data register for reverse operation.

11. Preset value

This setting configures the total number of output pulses from 1 to 100,000,000.

12. Current value

The number of pulses output from the pulse output port is stored in this data register.
The current value is updated when the RAMP instruction is executed at each scan.

13. Error status

If a configuration error occurs when the RAMP instruction input changes from off to on, M8004 (user program execution error) is turned on and this register is set to the error code.

| Error code | Description | |
|------------|---|---|
| 0 | Normal | — |
| 2 | Initial pulse frequency designation error | The initial pulse frequency was not set between 1 and 10,000 in operation mode 0. The initial pulse frequency was not set between 20 and 10,000 in operation mode 1. |
| 3 | Preset value designation error | The preset value was not set between 1 to 100,000,000. |
| 4 | Steady pulse frequency designation error | The steady pulse frequency was not set between 1 and 10,000 in operation mode 0. The steady pulse frequency was not set between 20 and 10,000 in operation mode 1. |
| 5 | Frequency change time designation error | The frequency change time was not set between 10 and 10,000. |
| 7 | Control direction designation error | The control direction was not set to 0 or 1. |
| 8 | Exceeded pulse count error | The number of frequency change pulses exceed the total number of output pulses (Note 1). |
| 9 | The initial pulse frequency was set to the same frequency as the steady pulse frequency or it was set to a value larger than the steady pulse frequency (Note 2). | |

Notes 1: The number of pulses in the frequency change region calculated by the initial pulse frequency, steady pulse frequency, and frequency change time has exceeded the total number of output pulses. Adjust the settings by decreasing the steady or initial pulse frequency or by shortening the frequency change time.

Notes 2: Set the initial pulse frequency so that it is lower than the steady pulse frequency.

Examples: RAMP

RAMP1 instruction (reversible control disabled) timing chart

[RAMP1 instruction, S1 is specified as D200, D1 is specified as internal relay M50]

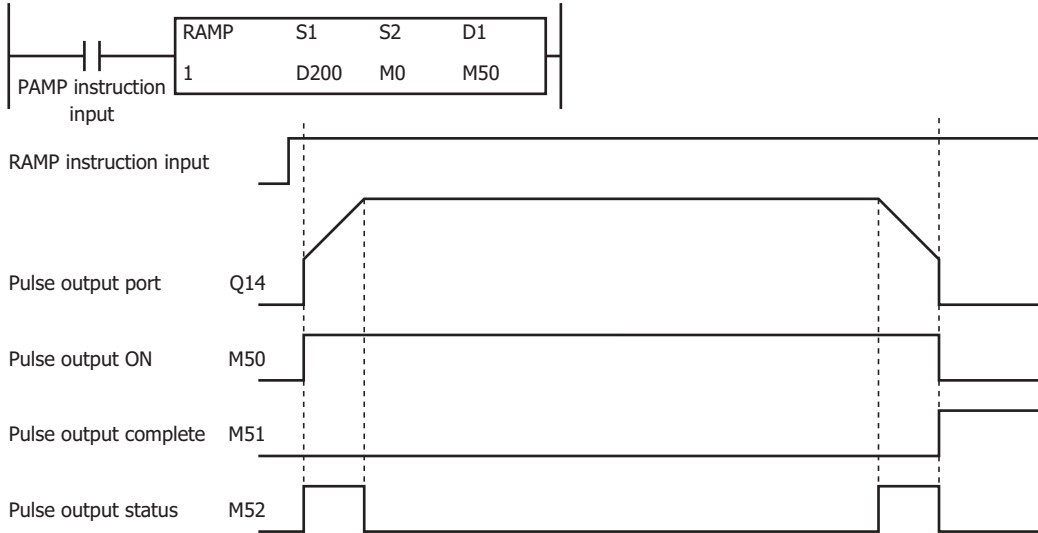

When the RAMP instruction input is on, pulses are output according to the settings configured by the control registers. M50 turns on during pulse output. M52 turns on or off while increasing or decreasing the pulse frequency. Pulses are output according to the frequency change time, until they reach the steady pulse frequency (from the initial pulse frequency). The frequency increases or decreases every 10 ms. Pulse output stops when the pulses configured by the preset value are output. At this time, M50 turns off and M51 turns on.

If the RAMP instruction input turns off during pulse output, pulse output is canceled. If the RAMP instruction input turns on again, the pulse count is reset and pulse counting starts. Even if the contents of the control registers are changed during pulse output, the change is not reflected in the pulse output operation. The changed content is reflected the next time the RAMP instruction is executed.

The changes from the initialization input are not reflected while the RAMP1 instruction input is on. If you wish to initialize the data registers with the initialization input, turn the initialization input on after turning off the input.

RAMP1 instruction (reversible control enabled, single-pulse output mode) timing chart

[RAMP1 instruction, S1 is specified as D200, D1 is specified as internal relay M50]

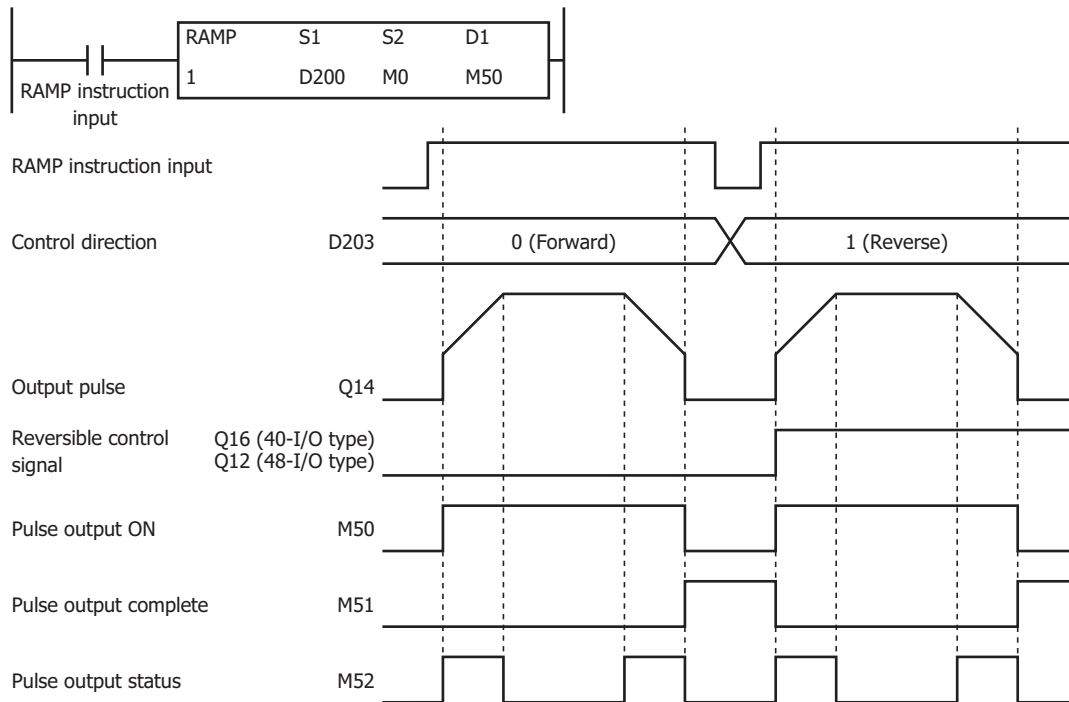

When the RAMP instruction input is on, pulses are output according to the settings configured by the control registers. The reversible control signal is output from Q16 or Q12. When pulse output starts, M50 turns on. M52 turns on while the pulse frequency is increasing or decreasing. The pulses increase according to the frequency change time every 10 ms until they reach the steady pulse frequency (from the initial pulse frequency). When the configured number of pulses are output, the pulses stop. In this situation, M50 turns off and M51 turns on.

If the RAMP instruction input turns off during pulse output, pulse output is canceled. If this input turns on again, the operation starts from the beginning. Even if the contents of the data registers are changed during pulse output, the change is not reflected in the pulse output operation. The changed content is reflected the next time the RAMP instruction is started.

The changes from the initialization input are not reflected while the RAMP1 instruction input is on. If you wish to initialize the data registers with the initialization input, turn the initialization input on after turning off the input.

19: PULSE OUTPUT INSTRUCTIONS

RAMP1 instruction (reversible control enabled, dual-pulse output mode) timing chart

[RAMP1 instruction, S1 is specified as D200, D1 is specified as internal relay M50]

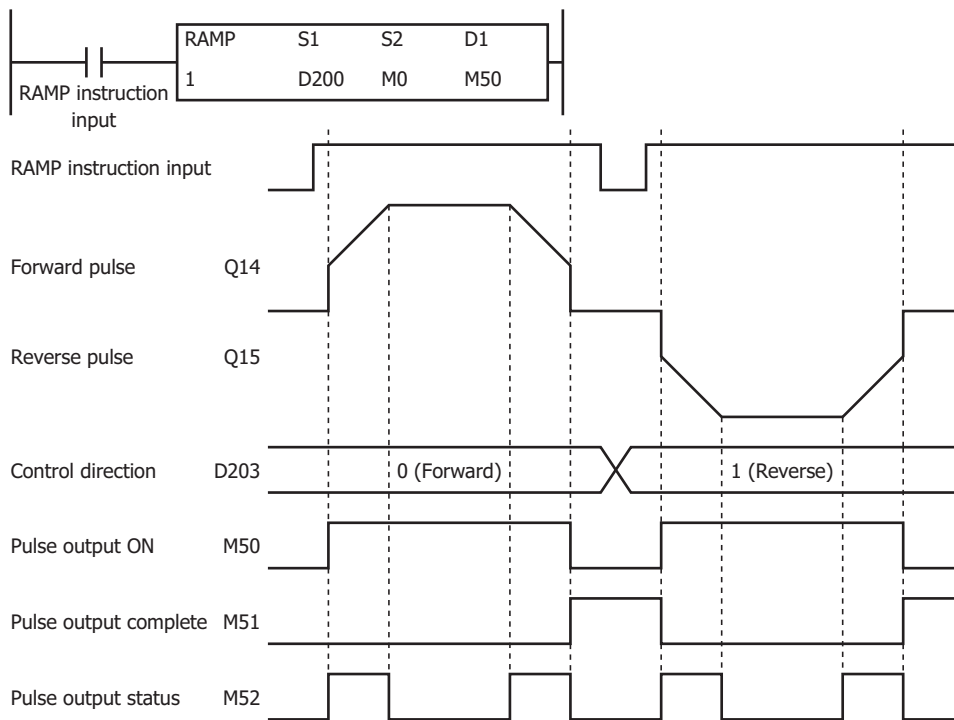

When the RAMP instruction input changes from off to on, pulses are output from Q14 or Q15 according to the settings configured by the data registers. When pulse output starts, M50 turns on. M52 turns on while the pulse frequency is increasing or decreasing. The pulses increase according to the frequency change time every 10 ms until they reach the steady pulse frequency (from the initial pulse frequency). When the configured number of pulses are output, the pulses stop. In this situation, M50 turns off and M51 turns on.

If the RAMP instruction input turns off during pulse output, pulse output is canceled. If this input turns on again, the operation starts from the beginning. Even if the contents of the data registers are changed during pulse output, the change is not reflected in the pulse output operation. The changed content is reflected the next time the RAMP instruction is started.

The changes from the initialization input are not reflected while the RAMP1 instruction input is on. If you wish to initialize the data registers with the initialization input, turn the initialization input on after turning off the input.

Sample program

[To output 48,000 pulses with the frequency change function (reversible control disabled) from Q14]

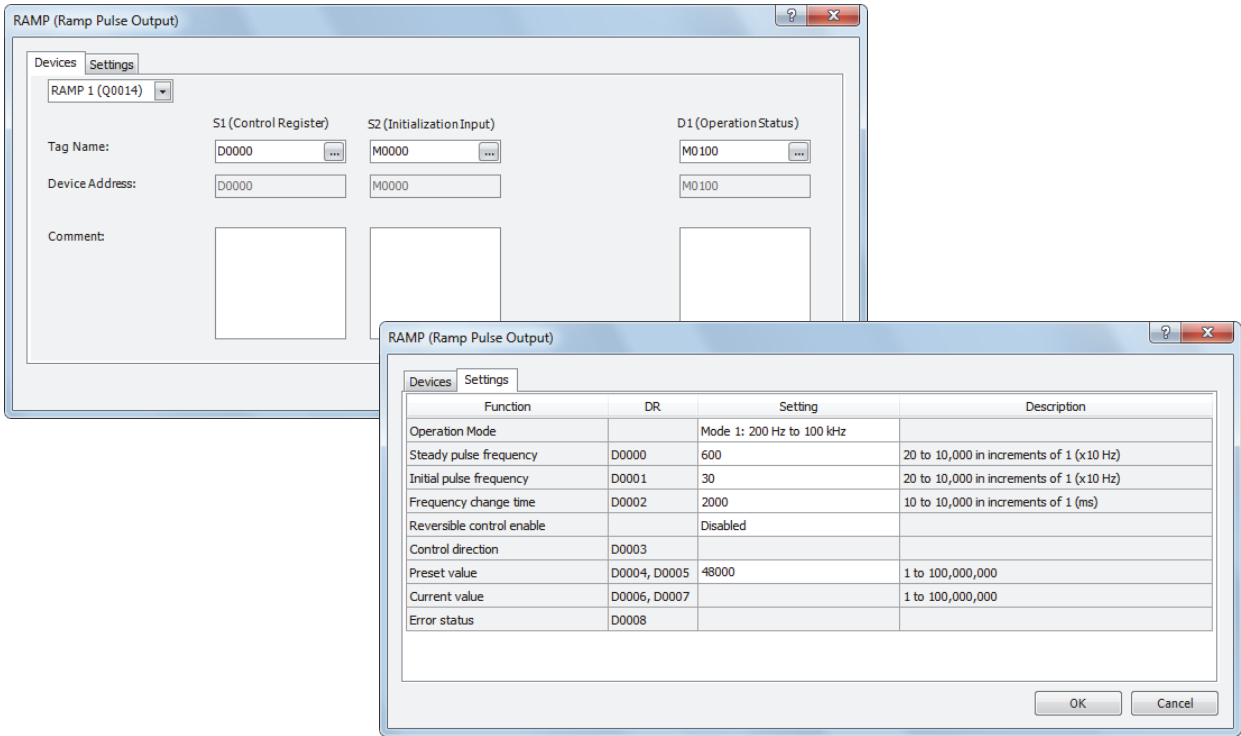
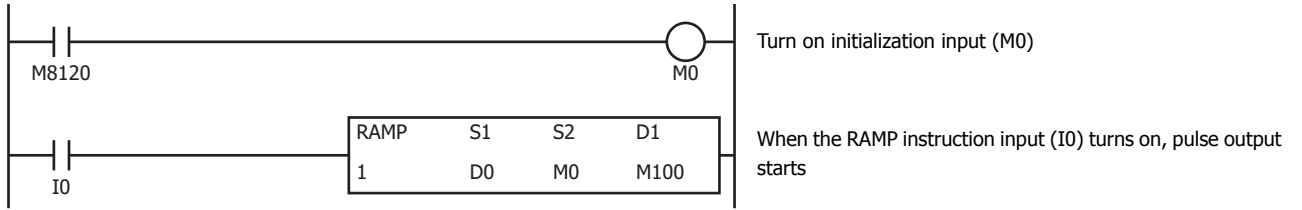

| Function | Device address | Setting value | Details |
|---------------------------|----------------|---------------|---------------------|
| Operation mode | — | Mode 1 | 200 Hz to 100 kHz |
| Steady pulse frequency | D0 | 600 | 6000 Hz |
| Initial pulse frequency | D1 | 30 | 300 Hz |
| Frequency change time | D2 | 2000 | 2,000 ms |
| Reversible control enable | — | Disable | — |
| Control direction | D3 | — | — |
| Preset value | D4, D5 | 48000 | Preset value=48,000 |

19: PULSE OUTPUT INSTRUCTIONS

[To output 100,000 pulses with the frequency change function (reversible control by single-pulse output) from Q14]

When the RAMP instruction input (I0) changes from off to on, pulse output starts. When I1 is off, the reversible control signal (Q15) turns off (forward).

When I1 is on, the reversible control signal (Q15) turns on (reverse).

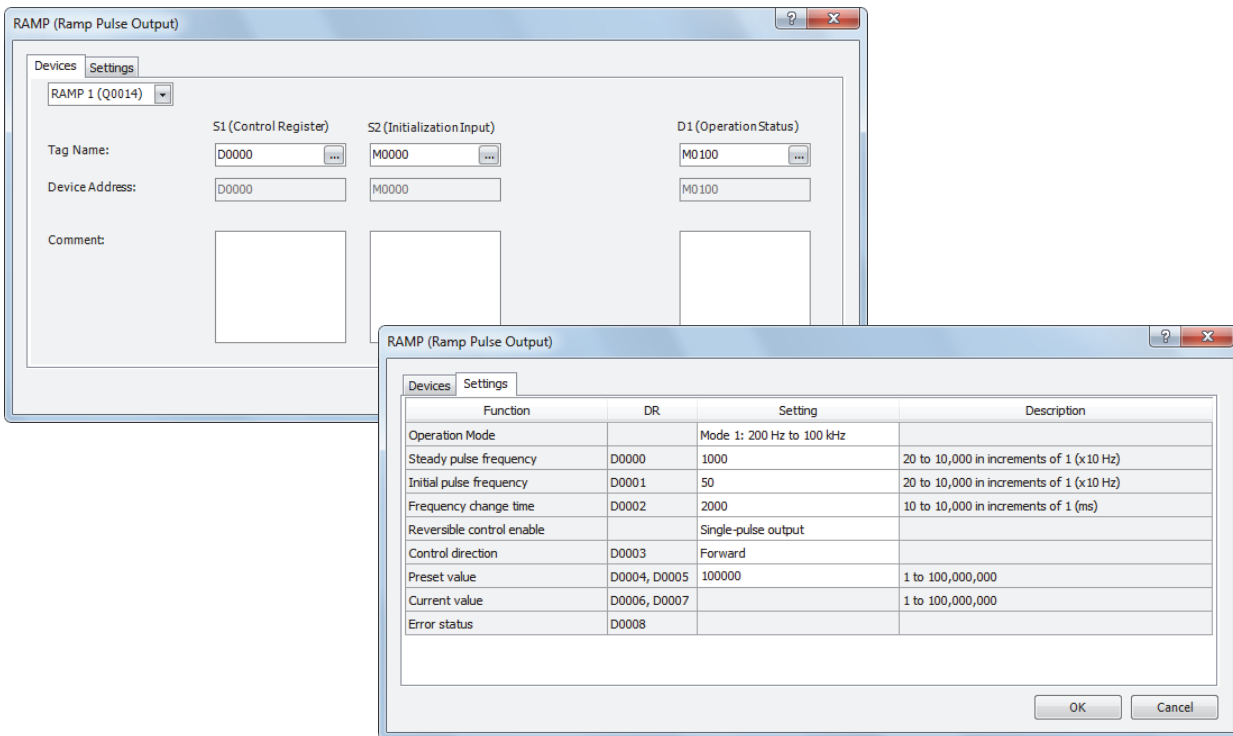
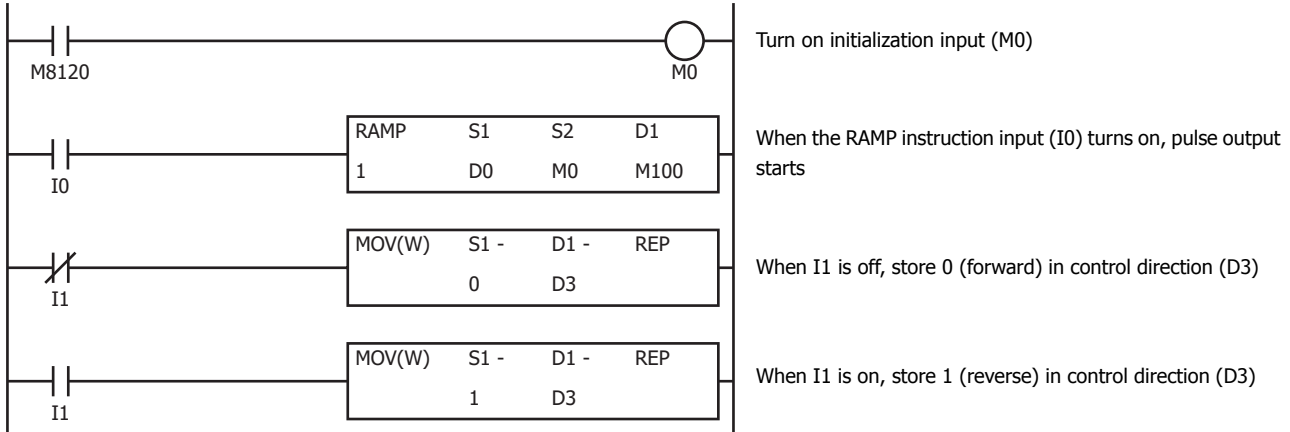

| Function | Device address | Setting value | Details |
|---------------------------|----------------|---------------------|----------------------|
| Operation mode | — | Mode 1 | 200 Hz to 100 kHz |
| Steady pulse frequency | D0 | 1000 | 10 kHz |
| Initial pulse frequency | D1 | 50 | 500 Hz |
| Frequency change time | D2 | 2000 | 2,000 ms |
| Reversible control enable | — | Single-pulse output | — |
| Control direction | D3 | Forward | Forward=0 |
| Preset value | D4, D5 | 100000 | Preset value=100,000 |

[To output 1,000,000 pulses with the frequency change function (reversible control by dual-pulse output)]

When the RAMP instruction input (I0) changes from off to on, pulse output starts. For forward when I1 is off, pulses (CW) are output from Q14.

For reverse when I1 is on, pulses (CCW) are output from Q15.

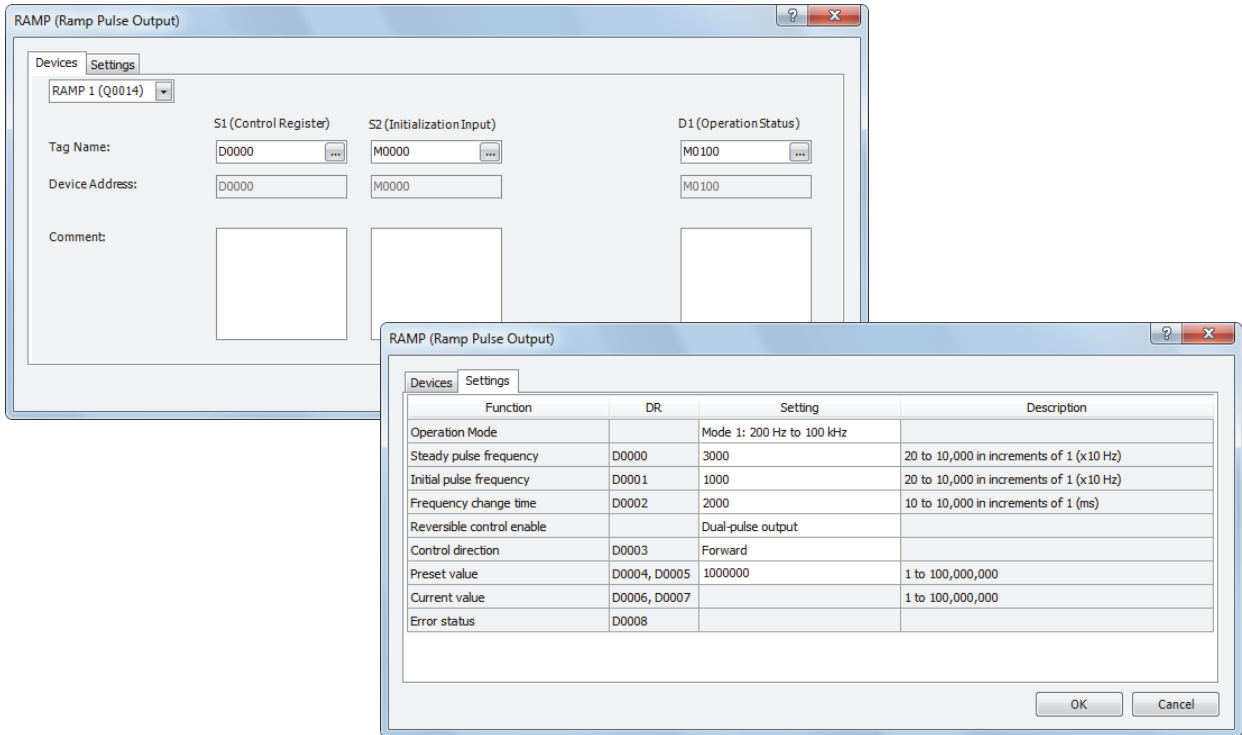
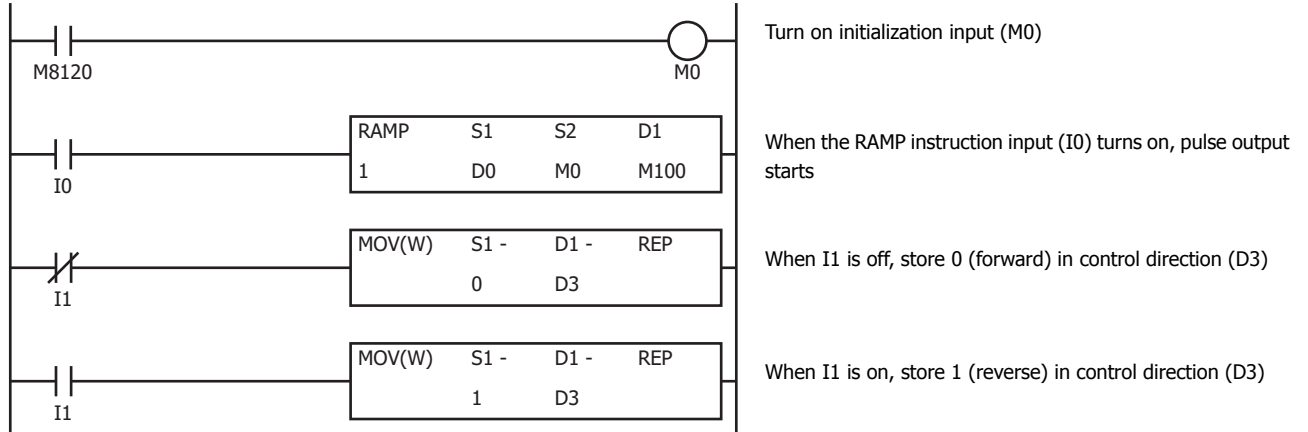

| Function | Device address | Setting value | Details |
|---------------------------|----------------|-------------------|------------------------|
| Operation mode | — | Mode 1 | 200 Hz to 100 kHz |
| Steady pulse frequency | D0 | 3000 | 30 Hz |
| Initial pulse frequency | D1 | 1000 | 10 kHz |
| Frequency change time | D2 | 2000 | 2,000 ms |
| Reversible control enable | — | Dual-pulse output | — |
| Control direction | D3 | Forward | Forward=0 |
| Preset value | D4, D5 | 1000000 | Preset value=1,000,000 |

ZRN (Zero Return)

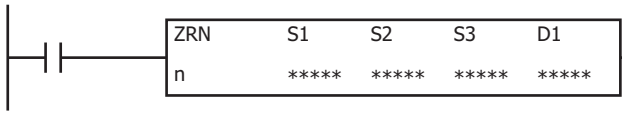

The ZRN instruction outputs pulses while the proximity signal is off.

When the input is on, pulses of the initial pulse frequency specified by S1 and S1+1 are output until the proximity signal specified by S3 turns on.

When the proximity signal turns on, pulses of the creep pulse frequency specified by S1+2 and S1+3 are output until the proximity signal turns off.

When the proximity signal turns off, pulse output stops.

Note: The ZRN instruction cannot be used in an interrupt program. If used, a user program execution error will result, turning on special internal relay M8004 and the ERR LED on the SmartAXIS. For details about the user program execution errors, see "User Program Execution Errors" on page 4-13.

Applicable SmartAXIS

| FT1A-12 | FT1A-24 | FT1A-40 | FT1A-48 | FT1A-Touch |
|---------|---------|----------|---------|------------|
| — | — | X (Note) | X | — |

Note: These instructions cannot be used with FT1A-H40RC and FT1A-B40RC.

Valid Devices

| Device | Function | I | Q | M | R | T | C | D | Constant | Repeat |
|--------------------|----------------------|---|---|---|---|---|---|---|----------|--------|
| S1 (Source 1) | Control register | — | — | — | — | — | — | ▲ | — | — |
| S2 (Source 2) | Initialization input | X | — | X | — | — | — | — | — | — |
| S2 (Source 3) | Proximity signal | X | — | X | — | — | — | — | — | — |
| D1 (Destination 1) | Operation status | — | — | ▲ | — | — | — | — | — | — |

▲ Special data registers cannot be designated as S1. Internal relays M0 through M1277 can be designated as D1. Special internal relays cannot be designated as D1. Caution: The first digit of the internal relay number must be 0 (not 1 to 7). Otherwise, the ZRN instruction will not operate correctly.

Settings

• **Device tab**

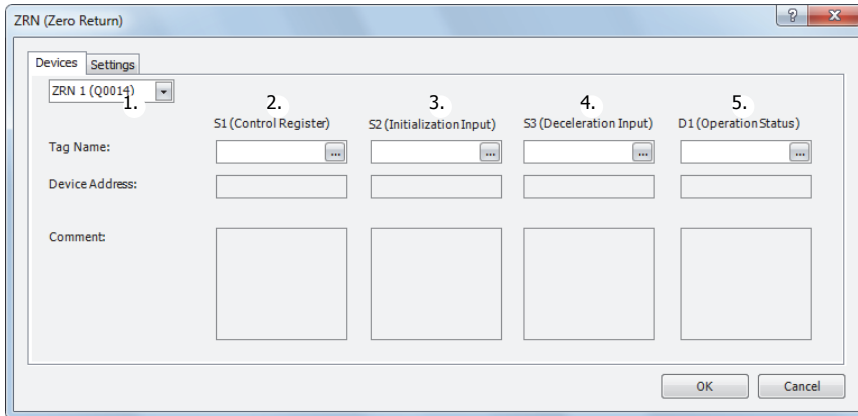

1. Select instruction

This item selects which ZRN instruction to use (ZRN1 or ZRN2).

The output differs by the instruction.

| Instruction | Pulse output |
|-------------|--------------|
| ZRN1 | Q14 |
| ZRN2 | Q15 |

2. S1 (source 1): Control register

S1 specifies the starting number of the data registers to use with ZRN1 or ZRN2 instructions.

Starting from the specified number, 3 consecutive 16-bit data registers are used.

The range of available data register numbers is D0 to D997 and D1000 to D1997.

| Storage destination | Function | Setting | Reference |
|---------------------|-------------------------|--|--|
| Starting number+0 | Initial pulse frequency | 0: 1 to 10,000 (increments of 1 Hz) 1: 20 to 10,000 (increments of 10 Hz) | "7. Initial pulse frequency" on page 19-28 |
| Starting number+1 | Creep pulse frequency | 0: 1 to 10,000 (increments of 1 Hz) 1: 20 to 10,000 (increments of 10 Hz) | "9. Creep pulse frequency" on page 19-29 |
| Starting number+2 | Error status | 0/2 | "10. Error status" on page 19-29 |

3. S2 (source 2): Initialization input

S2 specifies the initialization input. When the initialization input S2 is turned on, the initial values configured in the WindLDR ZRN instruction dialog box, on the **Setting** tab, are stored in the control registers. An external input (I0 to I35) (Note) or an internal relay (M0 to M1277) can be specified.

When the initialization input is on, the initial values are written to the data registers with each scan. To only initialize the values one time, use the initialization input in combination with the SOTU (single output up) instruction or the SOTD (single output down) instruction.

Note: For the 40-I/O type, external inputs (I0 to I27) can be used.

19: PULSE OUTPUT INSTRUCTIONS

4. S3 (source 3): Proximity signal

S3 specifies the proximity signal. Specify either an external input or an internal relay. The external input can be specified as (I0 to I35) or the internal relay can be specified as (M0 to M1277).

| | | |
|------------|-----------------------------------|--|
| High-speed | I0, I2, I3, I5, I6, I7 | An interrupt is used to read the proximity signal. The proximity signal can be read without being affected by the user program scan. |
| Normal | I1, I4, I10 to I35 M0 to M1277 | The information updated in the END processing is read as the proximity signal. It is affected by the user program scan. |

Notes:

- Do not use the same input or internal relay as the proximity signal for the ZRN1 and ZRN2 instructions. If they operate simultaneously, pulse output may not stop even if the proximity signal changes from on to off.
- To use the high-speed proximity signal, set the relevant input to **Normal Input** under **Special Input** on **Function Area Settings**. Do not use the input as interrupt input, catch input, high-speed counter, or frequency measurement.
- When using the high-speed proximity signal, ensure that no chatter noise occurs in the proximity signal.

5. D1 (destination 1): Operation status

D1 specifies the starting number of the internal relays to use with the ZRN1 and ZRN2 instructions. Starting from the specified internal relay, this instruction uses 2 sequential internal relays. The range of available internal relays is M0 to M1270. Caution: The first digit of the internal relay number must be 0 (not 1 to 7). Otherwise, the ZRN instruction will not operate correctly.

| Storage destination | Function | Setting | |
|---------------------|-----------------------------|--|---|
| Starting number+0 | Pulse output ON relay | 0: Pulse output OFF 1: Pulse output ON | This relay turns on during pulse output. This relay turns off when ZRN instruction output stops or when the proximity signal turns off and pulse output ends. |
| Starting number+1 | Pulse output complete relay | 0: Pulse output not complete 1: Pulse output complete | This relay turns on when the proximity signal turns off and pulse output end. This relay turns off when ZRN instruction output starts. |

• Setting tab

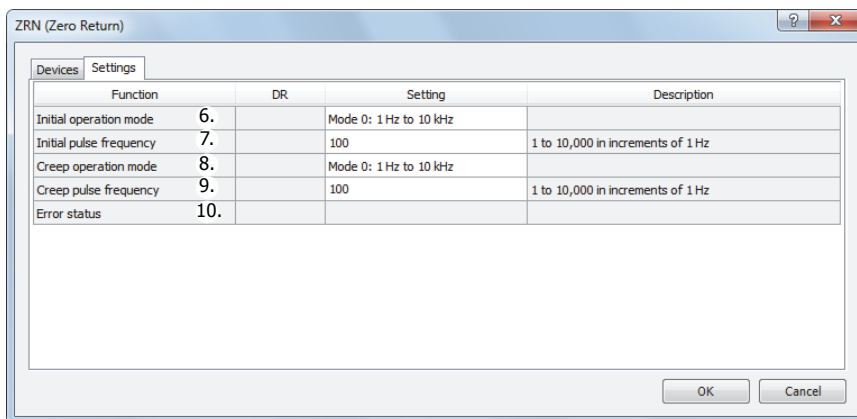

6. Initial operation mode

This setting selects the range of frequencies to output from the two modes.

| Initial operation mode |
|--|
| 0: 1 Hz to 10 kHz (increments of 1 Hz) |
| 1: 200 Hz to 100 kHz (increments of 10 Hz) |

7. Initial pulse frequency

This setting specifies the initial pulse frequency to output.

Initial operation mode 0: Set between 1 Hz and 10 kHz in increments of 1 Hz.

Initial operation mode 1: Set between 200 Hz and 100 kHz in increments of 10 Hz.

8. Creep operation mode

This setting selects the range of frequencies to output from the two modes.

| Creep operation mode |
|--|
| 0: 1 Hz to 10 kHz (increments of 1 Hz) |
| 1: 200 Hz to 100 kHz (increments of 10 Hz) |

9. Creep pulse frequency

This setting specifies the creep pulse frequency to output.

Creep operation mode 0: Set between 1 Hz and 10 kHz in increments of 1 Hz.

Creep operation mode 1: Set between 200 Hz and 100 kHz in increments of 10 Hz.

10. Error status

If a configuration error occurs when the ZRN instruction is being executed, M8004 (user program execution error) is turned on and this relay is set to the error code.

| Error code | Status | Description |
|------------|-----------------------------------|---|
| 0 | Normal | — |
| 2 | Pulse frequency designation error | The pulse frequency was not set between 1 and 10,000 in initial pulse operation mode 0/creep operation mode 0. The pulse frequency was not set between 20 and 10,000 in initial pulse operation mode 1/creep operation mode 1. |

Examples: ZRN

ZRN1 instruction timing chart

[ZRN1 instruction, S1 is specified as data register D200, S3 is specified as external input I2, D1 is specified as internal relay M10]

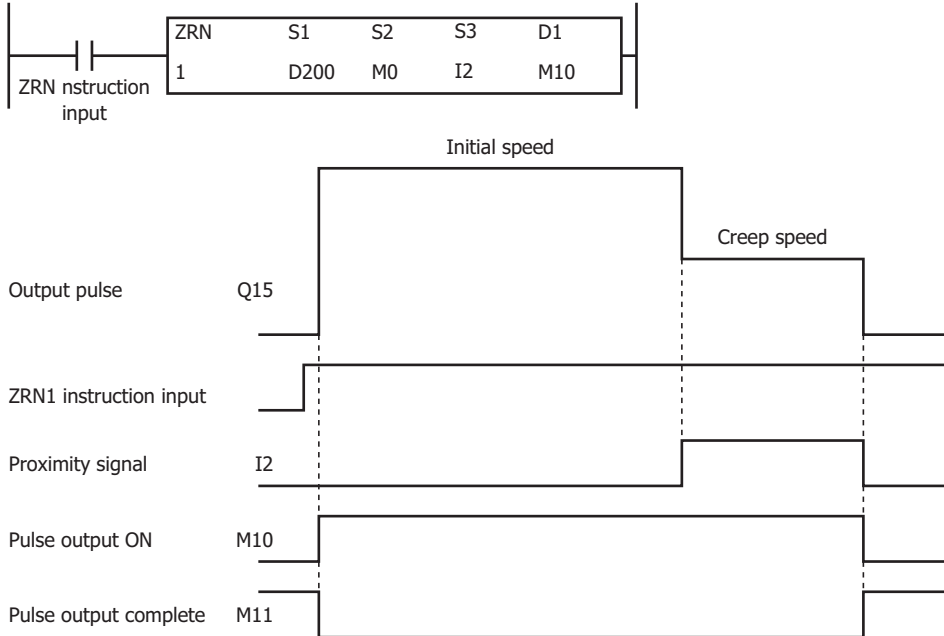

When the ZRN1 instruction changes from off to on, pulses are output at the initial pulse frequency. When pulse output starts, M10 turns on and M11 turns off. When I2 changes from off to on, pulses are output at the creep pulse frequency. When I2 changes from on to off, pulse output stops. When pulse output stops, M10 turns off and M11 turns on.

If the ZRN1 instruction input turns off during pulse output, pulse output stops. If the input turns on again, the operation starts from the beginning. Even if the contents of the data registers are changed during pulse output, the change is not reflected in the pulse output operation. The changed content is reflected the next time the ZRN1 instruction starts.

The changes from the initialization input are not reflected while the ZRN1 instruction input is on. If you wish to initialize the data registers with the initialization input, turn the initialization input on after turning off the input.

Sample program

[To perform a zero return operation with proximity signal I3, initial pulse frequency 3 kHz, and creep pulse frequency 800 Hz]

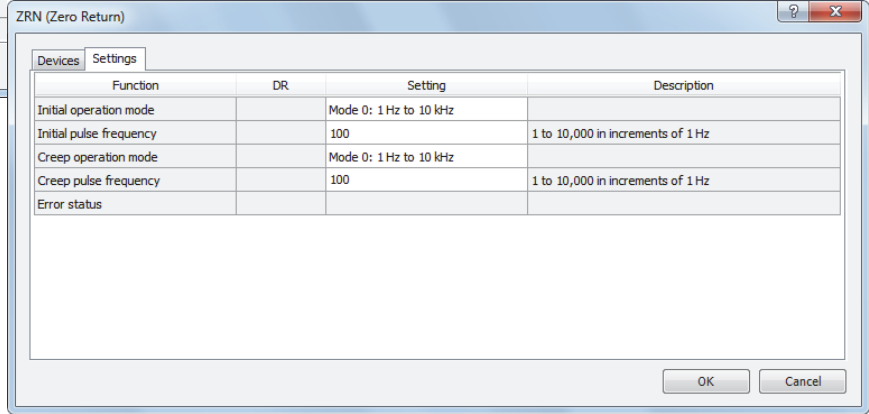
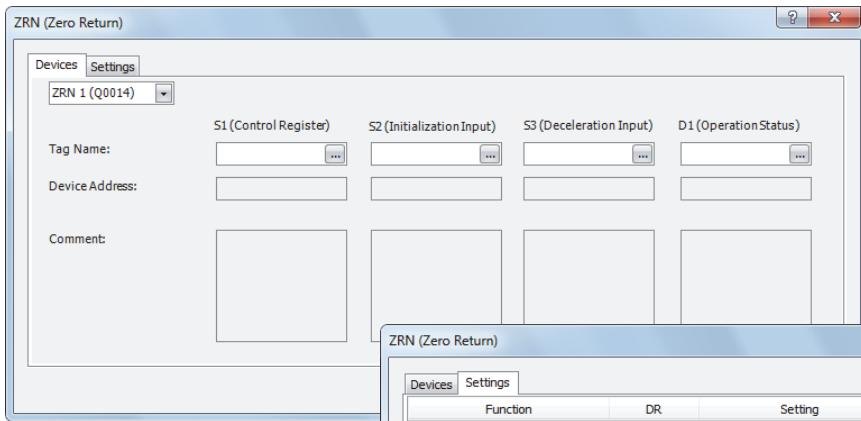
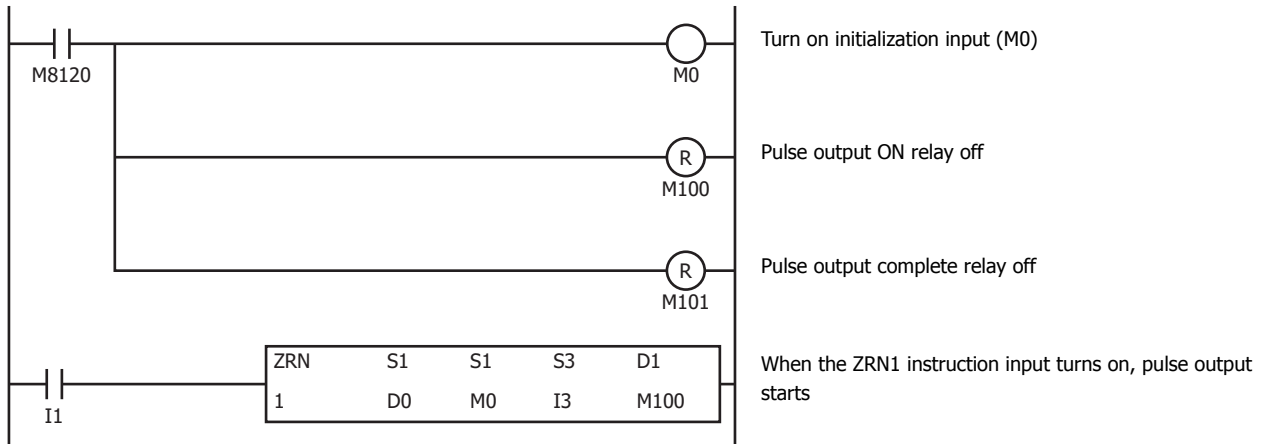

| Function | Device address | Setting value | Details |
|-------------------------|----------------|---------------|----------------|
| Initial operation mode | — | Mode 0 | 1 Hz to 10 kHz |
| Initial pulse frequency | D0 | 3000 | 3 kHz |
| Creep operation mode | — | Mode 0 | 1 Hz to 10 kHz |
| Creep pulse frequency | D1 | 800 | 800 Hz |

ARAMP (RAMP with Table)



The ARAMP instructions output pulses with the frequency change function according to the information in the frequency table.

When the input is on, pulses are output according to the frequency change settings stored in the control register settings specified by S1. The pulse frequency is controlled by combining multiple steps that define the change time and steady pulse speed. The pulses change frequency at a constant rate until they reach the steady pulse frequency in the step option settings. You can select to output pulses at the steady pulse frequency or to change the frequency at a constant rate until the steady pulse frequency is reached, after pulses that maintain the frequency in the previous step are output. The next step is executed when the number of pulses output reaches the preset value. You can configure a maximum of 18 steps.

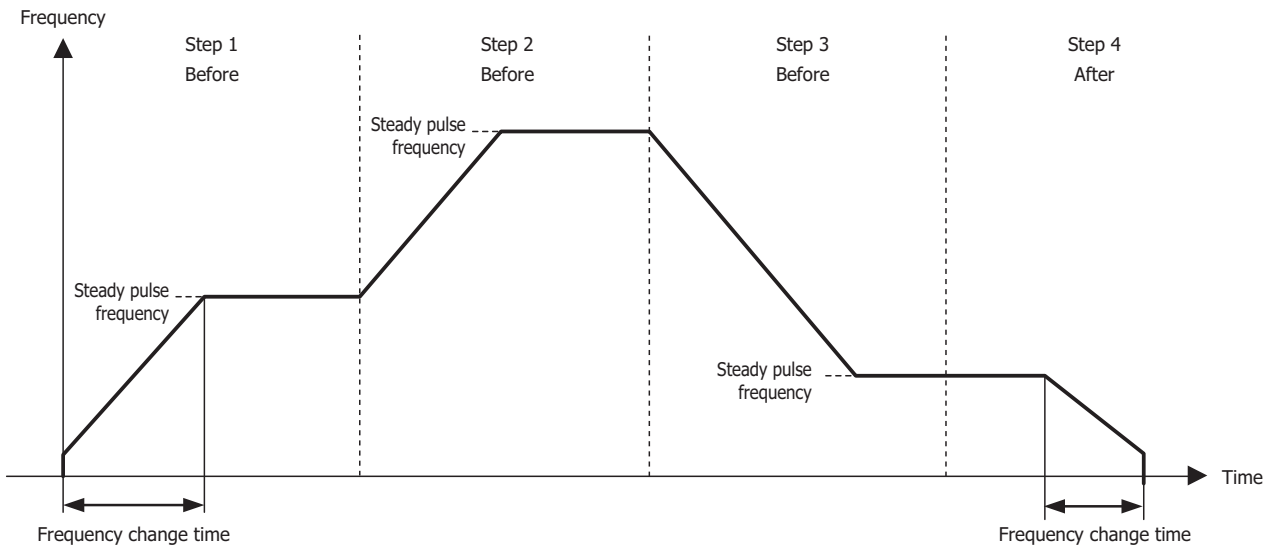

When the initialization input specified by S2 is turned on, the initial values configured in the WindLDR ARAMP instruction are stored in the control registers.

When the interrupt input configured by S3 is turned on, the step being executed is aborted and the interrupt step is executed. The settings for the step being executed, including the preset value and the steady pulse frequency, are stored in the data registers specified by D1.

The control status, including the pulse output status (output on, output direction, output complete), is set as the operation status in the internal relays specified by D2.

Note: Configure multiple PULS (pulse output), PWM (pulse width modulation), RAMP (ramp control), and ARAMP (RAMP with table) instructions so that they do not share the same pulse output port.

However, the ZRN (zero return) instruction can be configured with the same pulse output port as the PULS (pulse output), PWM (pulse width modulation), RAMP (ramp control), and ARAMP (RAMP with table) instructions.

Note: The ARAMP instruction cannot be used in an interrupt program.

If used, a user program execution error will result, turning on special internal relay M8004 and the ERR LED on the SmartAXIS. For details about the user program execution errors, see "User Program Execution Errors" on page 4-13.

Applicable SmartAXIS

| FT1A-12 | FT1A-24 | FT1A-40 | FT1A-48 | FT1A-Touch |
|---------|---------|----------|---------|------------|
| — | — | X (Note) | X | — |

Note: These instructions cannot be used with FT1A-H40RC and FT1A-B40RC.

Valid Devices

| Device | Function | I | Q | M | R | T | C | D | Constant | Repeat |
|--------------------|----------------------|---|---|---|---|---|---|---|----------|--------|
| S1 (Source 1) | Control register | — | — | — | — | — | — | ▲ | — | — |
| S2 (Source 2) | Initialization input | X | — | X | — | — | — | — | — | — |
| S3 (Source 3) | Interrupt input | X | — | X | — | — | — | — | — | — |
| D1 (Destination 1) | Monitor register | — | — | — | — | — | — | ▲ | — | — |
| D2 (Destination 2) | Operation status | — | — | ▲ | — | — | — | — | — | — |

▲ Special data registers cannot be designated as S1. Internal relays M0 through M1277 can be designated as D1. Special internal relays cannot be designated as D1. The first digit of the internal relay number must be set to 0.

Settings

- **Device tab**

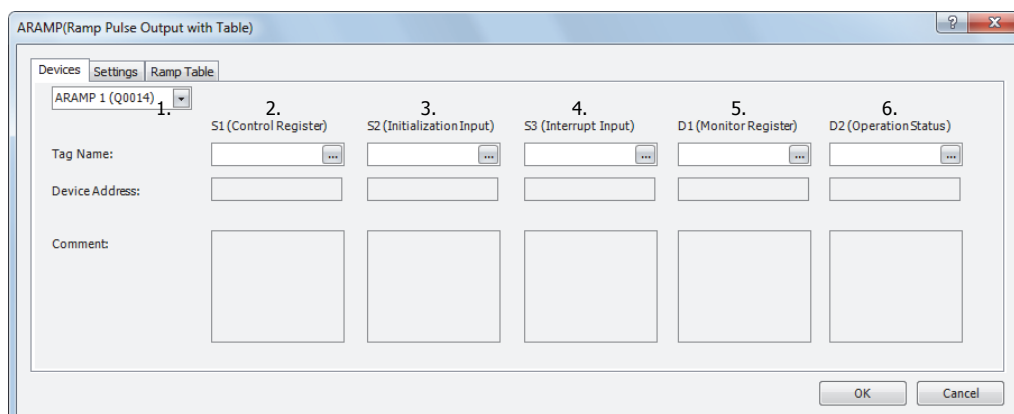

1. Select instruction

This item selects which ARAMP instruction to use (ARAMP1 or ARAMP2).

The reversible control mode that can be selected varies based on the instruction.

For limitations based on the combination of instruction, reversible control mode, and the pulse output mode, see "8. Reversible control enable" on page 19-37.

2. S1 (source 1): Control register

S1 specifies the starting number of the data registers to use with the ARAMP1 or ARAMP2 instruction.

Starting from the specified data register, "2+6 x N (N: number of steps)" consecutive 16-bit data registers are used.

The range of available data register numbers is D0 to D992 (dependent on the number of steps).

The steps operate with the settings that are configured when the steps start. If the settings for a step are changed after it starts running, those changes are not reflected while the step is running.

| Storage destination | Function | Setting | Reference |
|-------------------------|---------------------------------|--|--|
| Starting number+0 | Interrupt number | 1 to 18 | "11. Interrupt number" on page 19-37 |
| Starting number+1 | Reserved | | |
| Step 1 (6 words) | | | |
| Starting number+2 | Steady pulse frequency | Mode 0: 1 to 10,000 (increments of 1 Hz) Mode 1: 20 to 10,000 (increments of 10 Hz) | "13. Steady pulse frequency" on page 19-38 |
| Starting number+3 | Frequency change time | 10 to 10,000 ms | "14. Frequency change time" on page 19-38 |
| Starting number+4 | Preset value (high word) (Note) | 1 to 100,000,000 pulses | "15. Preset value" on page 19-38 |
| Starting number+5 | Preset value (low word) (Note) | | |
| Starting number+6 | Step options | 0 to 3 | "16. Step options" on page 19-38 |
| Starting number+7 | Next step number | 1 to 18 | "17. Next step number" on page 19-38 |

Note: The upper and lower data registers change according to the 32-bit data storage method specified.

For details, see Chapter 5 "Special Functions" – "32-bit Data Storage Setting" in the SmartAXIS Pro/Lite User's Manual.

19: PULSE OUTPUT INSTRUCTIONS

Step 2 (6 words)

| Storage destination | Function | Setting | Reference |
|---------------------|------------------------|--|--|
| Starting number+8 | Steady pulse frequency | Mode 0: 1 to 10,000 (increments of 1 Hz) Mode 1: 20 to 10,000 (increments of 10 Hz) | "13. Steady pulse frequency" on page 19-38 |
| : | : | : | : |
| Starting number+13 | Next step number | 1 to 18 | "17. Next step number" on page 19-38 |

Step N (6 words)

| | | | |
|---------------------------|------------------------|--|--|
| Starting number+2+N x 6-6 | Steady pulse frequency | Mode 0: 1 to 10,000 (increments of 1 Hz) Mode 1: 20 to 10,000 (increments of 10 Hz) | "13. Steady pulse frequency" on page 19-38 |
| : | : | : | : |
| Starting number+7+N x 6-6 | Next step number | 1 to 18 | "17. Next step number" on page 19-38 |

3. S2 (source 2): Initialization input

S2 specifies the initialization input.

When the initialization input S2 is turned on, the initial values configured in the WindLDR ARAMP instruction dialog box, on the **Setting** tab, are stored in the control registers.

An external input (I0 to I35) (Note) or an internal relay (M0 to M1277) can be specified.

When the initialization input is on, the initial values are written to the data registers with each scan. To only initialize the values one time, use the initialization input in combination with the SOTU (single output up) instruction or the SOTD (single output down) instruction.

Note: For the 40-I/O type, external inputs (I0 to I27) can be used.

4. S3 (source 3): Interrupt input

When the interrupt input changes from off to on, the pulse output process for the running step is aborted, and pulse output restarts with the settings for the step configured by the interrupt number.

In the following example, the interrupt input turns on while step 2 is running. Pulse output processing for step 2 aborts and the operation transitions to step 12.

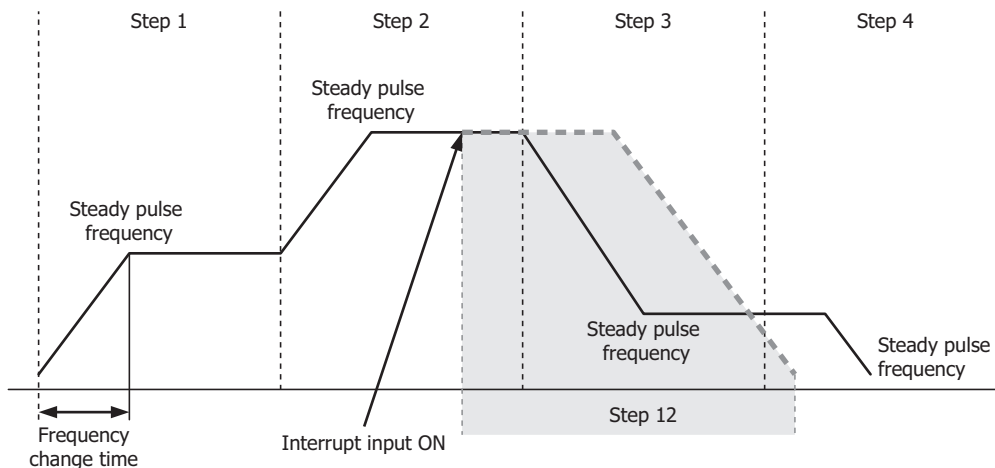

An external input (I0 to I35) or internal relay (M0 to M1277) can be specified as the interrupt input.

| | | |
|------------|-----------------------------------|---|
| High-speed | I0, I2, I3, I5, I6, I7 | An interrupt is used to read the interrupt input. The interrupt input can be read without being affected by the user program scan. |
| Normal | I1, I4, I10 to I35 M0 to M1277 | The information updated in the END processing is read as the interrupt input. It is affected by the user program scan. |

Notes:

- Do not use the same input or internal relay as the interrupt input signal for the ARAMP1 and ARAMP2 instructions.
- To use the high-speed interrupt input signal, set the relevant input to **Normal Input** under **Special Input** on **Function Area Settings**. Do not use the input as interrupt input, catch input, high-speed counter, or frequency measurement.
- When using the high-speed interrupt input, ensure that no chatter noise occurs in the interrupt input.
- When the interrupt input is turned on, the control direction (forward or reverse) is unchanged regardless of the control direction of the interrupted step.

5. D1 (destination 1): Monitor register

D1 specifies the starting number of the data registers to use with ARAMP1 or ARAMP2. Starting from the specified number, 9 consecutive 16-bit data registers are used. The range of available data register numbers is D0 to D991 and D1000 to D1991. The contents of the monitor registers are read-only.

| Address | Description | | Value range (unit) |
|-------------------|--------------------------------|--------------------|--|
| Starting number+0 | Next step number | | 0 to 18 |
| Starting number+1 | Running step number | | 1 to 18 |
| Starting number+2 | Steady pulse frequency monitor | | Mode 0: 1 to 10,000 (increments of 1 Hz), mode 1: 20 to 10,000 (increments of 10 Hz) |
| Starting number+3 | Frequency change time monitor | | 10 to 10,000 ms |
| Starting number+4 | Preset value monitor | (High word) (Note) | 1 to 100,000,000 pulses |
| Starting number+5 | | (Low word) (Note) | |
| Starting number+6 | Current value | (High word) (Note) | 1 to 100,000,000 pulses |
| Starting number+7 | | (Low word) (Note) | |
| Starting number+8 | Error status | | 0 to 9 |

Note: The upper and lower data registers change according to the 32-bit data storage method specified. For details, see Chapter 5 "Special Functions" – "32-bit Data Storage Setting" in the SmartAXIS Pro/Lite User's Manual.

Next step

This register stores the number of the step to execute next.
If the next step is 0, pulse output ends after the currently executed step is complete.

Running step

This register stores the number of the step that is currently being executed.

Steady pulse frequency monitor

This register stores the steady pulse frequency for the step that is currently being executed.

Frequency change time monitor

This register stores the frequency change time for the step that is currently being executed.
Set the time between 10 and 10,000 ms in increments of 10 ms. The first digit of the setting is discarded.

Preset value monitor

This register stores the preset value for the step that is currently being executed.

Current value

This register stores the number of pulses that have been output for the step that is currently being executed. The current value is updated when the ARAMP instruction is executed at each scan.

Error status

If a configuration error occurs when a step starts executing, M8004 (user program execution error) is turned on and this register is set to the error code.

| Error code | Status | Description |
|------------|--|--|
| 0 | Normal | — |
| 3 | Preset value designation error | The preset value was not set between 1 to 100,000,000. |
| 4 | Steady pulse frequency designation error | The frequency was not set between 1 to 10,000 in operation mode 0. The frequency was not set between 20 to 10,000 in operation mode 1. |
| 5 | Frequency change time designation error | The frequency change time was not set between 10 and 10,000. |
| 7 | Step options designation error | The step options were not set to a valid value. |
| 8 | Next step number destination error | The next step number was not set between 0 and 18. |
| 9 | Interrupt number destination error | The interrupt number was not set between 1 and 18. |

19: PULSE OUTPUT INSTRUCTIONS

6. D2 (destination 2): Operation status

D2 specifies the starting number of the internal relays to use with ARAMP1 and ARAMP2 instructions.

Starting from the specified internal relay, 5 sequential internal relays are used.

The range of available internal relay numbers is M0 to M1270. The first digit of the internal relay number must be set to 0.

| Address | Description | | |
|-------------------|------------------------|--|--|
| Starting number+0 | Pulse output ON | 0: Pulse output OFF 1: Pulse output ON | This relay turns on during pulse output. This relay turns off when the ARAMP instruction output stops. This relay turns off when the specified number of pulses are output and output ends |
| Starting number+1 | Pulse output complete | 0: Pulse output not complete 1: Pulse output complete | This relay turns on when pulse output completes. This relay turns on when the step number currently being executed is 0. This relay turns off when the ARAMP instruction output starts. |
| Starting number+2 | Pulse output status | 0: Steady pulse output 1: Changing output pulse frequency | This relay turns off when the pulse output status is steady. This relay turns on when the pulse output is changing. |
| Starting number+3 | Overflow | 0: None 1: An overflow has occurred | This relay turns on when the pulses output exceed the configured preset value. Pulse output continues even if an the overflow occurs during steady output or while the pulse frequency is changing. However, pulse counting (current value data register) is suspended at the point when the overflow occurred. |
| Starting number+4 | Pulse output direction | 0: Forward 1: Reverse | This relay turns off when the output direction of the pulses being output is forward. This relay turns on when the output direction of the pulses being output is reverse. |

• Setting tab

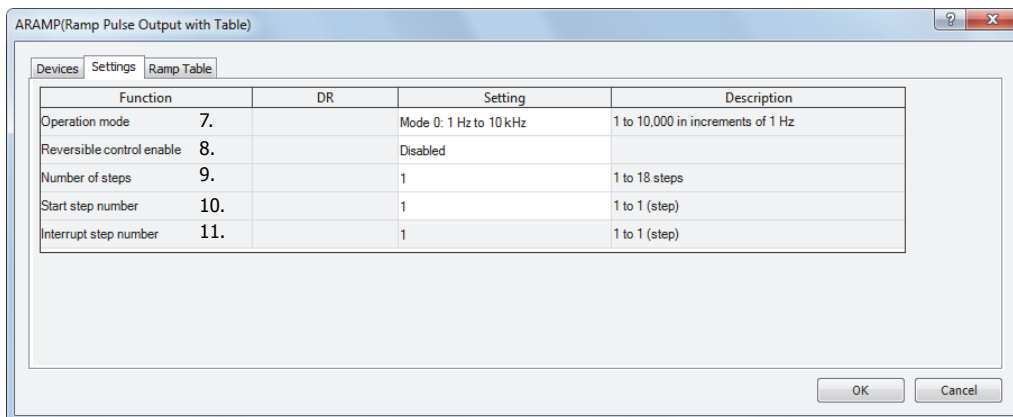

7. Operation mode

This setting selects the frequency range to output from following operation modes.

| Operation mode |
|---|
| 0: 1 Hz to 10 kHz (increments of 1 Hz) (Note) |
| 1: 200 Hz to 100 kHz (increments of 10 Hz) (Note) |

Note: The output frequency error is within $\pm 5\%$.

8. Reversible control enable

This setting enables or disables reversible control and selects the reversible control method from the following modes.

| Reversible control enable | |
|---------------------------|--|
| 0: | Reversible control disabled |
| 1: | Reversible control (single-pulse output) |
| 2: | Reversible control (dual-pulse output) |

There are two modes for the pulse output mode: single-pulse and dual-pulse. They can be combined with reversible control as follows.

| | | |
|---|--|--|
| Reversible control disabled | Select this option when using pulse output in a single direction. Pulse A and pulse B can be used independently. | |
| Reversible control Single-pulse output mode | Pulse A is used as pulse output. Pulse B on/off is used as reversible control. | |
| Reversible control Dual-pulse output mode | Pulse A is used as forward pulse (CW) output. Pulse B is used as reverse pulse (CCW) output. | |

The ports used on the SmartAXIS varies based on the instruction used, the combination of the pulse output mode and reversible control, and the model used.

| Instruction | Operating condition | Port used | | | |
|-------------|--|-------------------|-------------------------|-------------------|-------------------------|
| | | 40-I/O type | | 48-I/O type | |
| | | Pulse output port | Reversible control port | Pulse output port | Reversible control port |
| ARAMP1 | Reversible control disabled | Q14 | — | Q14 | — |
| | Reversible control (single-pulse output) | Q14 | Q16 (Note) | Q14 | Q12 |
| | Reversible control (dual-pulse output) | Q14 | Q15 | Q14 | Q15 |
| ARAMP2 | Reversible control disabled | Q15 | — | Q15 | — |
| | Reversible control (single-pulse output) | Q15 | Q17 (Note) | Q15 | Q13 |
| | Dual-pulse mode cannot be used. | — | — | — | — |

Note: When using single-pulse mode on the 40-I/O type, Q16 or Q17 are used. Therefore, PULS3, PWM3, or PULS4, PWM4 cannot be used.

9. The number of steps

This setting specifies the number of steps. The maximum is 18.

10. Start number

When the input changes from off to on, pulse output starts with the settings for the step configured as the start number.

11. Interrupt number

When the interrupt input changes from off to on, the pulse output process for the running step is aborted, and pulse output restarts with the settings for the step configured by the interrupt number.

• ARAMP step settings

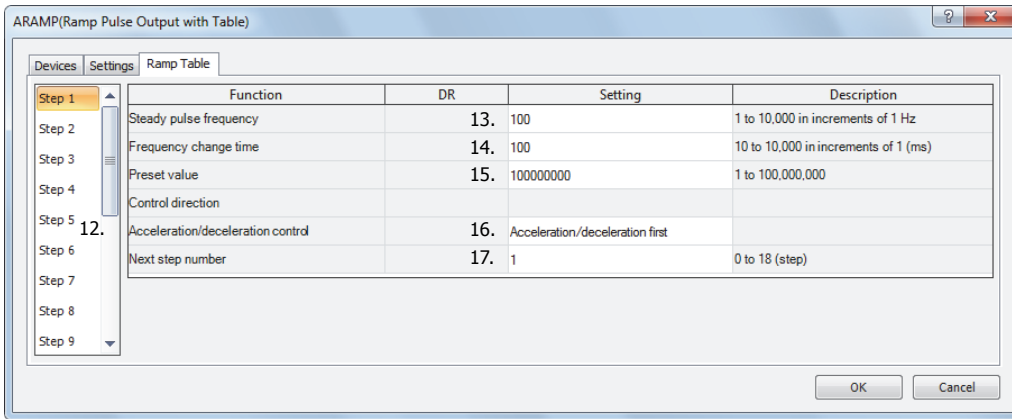

12. Step numbers

This option selects the step number to configure.

13. Steady pulse frequency

This setting specifies the frequency at the steady output state before or after changing the frequency.

For mode 0, set this value in the range of 1 to 10,000 (increments of 1 Hz).

For mode 1, set this value in the range of 20 to 10,000 (increments of 10 Hz).

14. Frequency change time

This setting specifies the time to change the pulses.

Set this value in the range of 10 to 10,000 (increments of 10 ms).

The first digit of the setting is discarded.

15. Preset value

This setting configures the number of pulses to output from 1 to 100,000,000.

16. Step options

This setting configures the step direction and the execution timing of the change in the pulses.

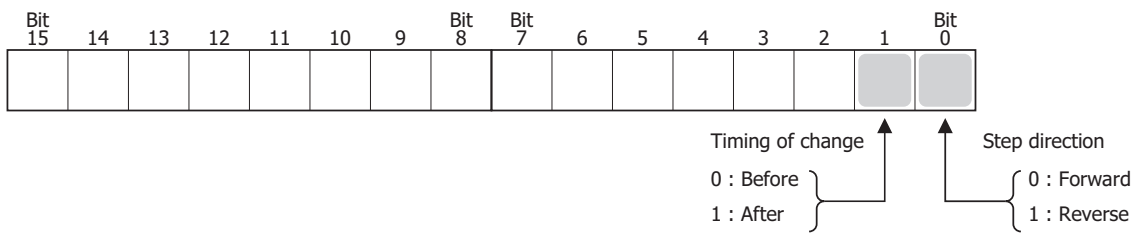

The frequency changes as shown in the following diagram according to the setting for the execution timing of the change. In the Before column, the frequency changes and then becomes steady. When the number of pulses in the preset value is output, the instruction transitions to the next step. In the After column, the steady pulse frequency is maintained, then the frequency changes, and the instruction transitions to the next step.

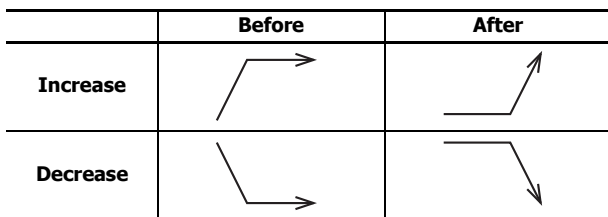

17. Next step number

This setting specifies the number of the next step to be executed after the output for the currently executed step is completed.

• **Preview**

The preview shows the operation with the content configured on the **Table** tab.

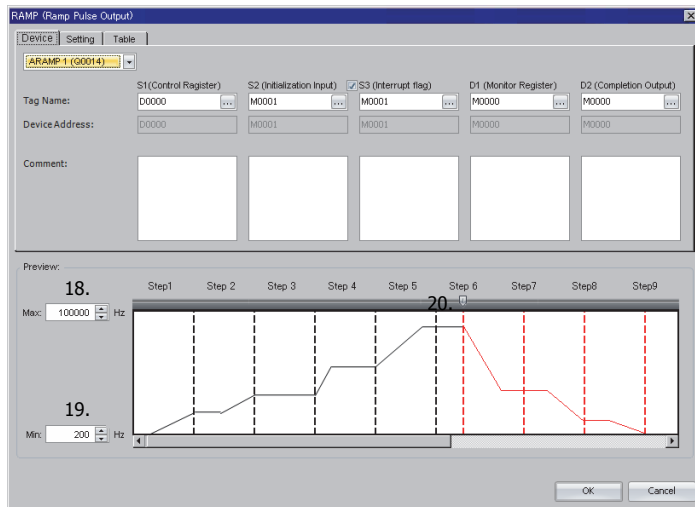

18. Max

This setting configures the maximum value for the graph. The range of values that can be entered depends on the selected mode.

19. Min

This setting configures the minimum value for the graph. The range of values that can be entered depends on the selected mode.

20. Slide bar

Move the slide bar to preview the operation when the interrupt input is executed.

Examples: ARAMP

ARAMP1 instruction (reversible control disabled) timing chart

[ARAMP1 instruction, S1 is specified as data register D200, S2 is specified as internal relay M0, S3 is disabled, D1 is specified as data register D0, D2 is specified as internal relay M50]

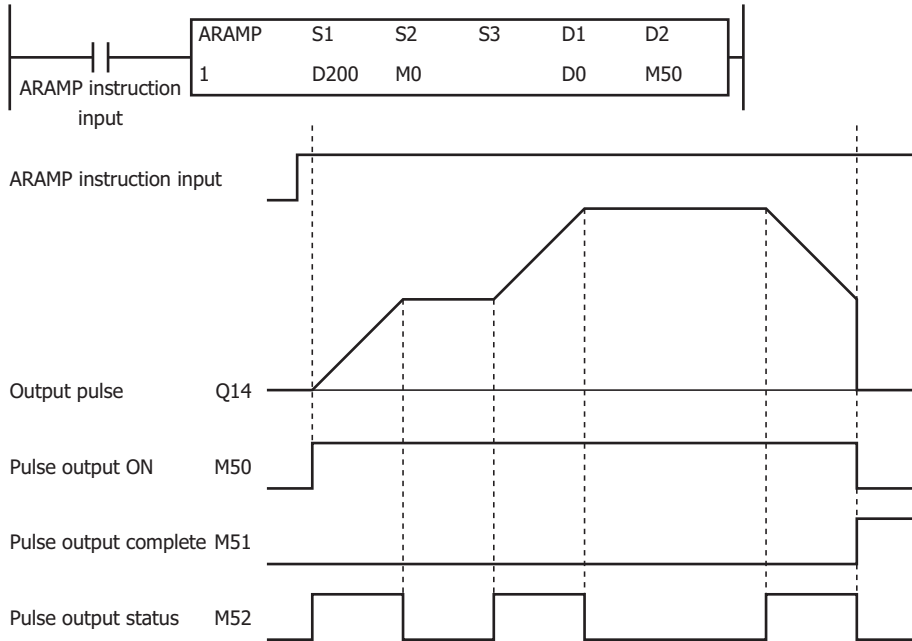

When the ARAMP instruction input changes from off to on, pulses are output from Q14 according to the settings configured by the data registers. When pulse output starts, M50 turns on. M52 turns on while the pulse frequency is increasing or decreasing. The pulses increase according to the frequency change time until they reach the steady pulse frequency (from the initial pulse frequency). When the configured number of pulses are output, the pulses stop. In this situation, M50 turns off and M51 turns on. If the ARAMP instruction input turns off during pulse output, pulse output ends. If the ARAMP instruction input turns on again, the operation starts from the beginning. Even if the contents of the data registers are changed during pulse output, the change is not reflected in the pulse output operation. The changed content is reflected the next time the ARAMP instruction is started. The changes from the initialization input are not reflected while the ARAMP instruction input is on. If you wish to initialize the data registers with the initialization input, turn the initialization input on after turning off the ARAMP instruction input.

ARAMP1 instruction (single-pulse output reversible control enabled) timing chart

[ARAMP1 instruction, S1 is specified as data register D200, S2 is specified as internal relay M0, S3 is disabled, D1 is specified as data register D0, D2 is specified as internal relay M50]

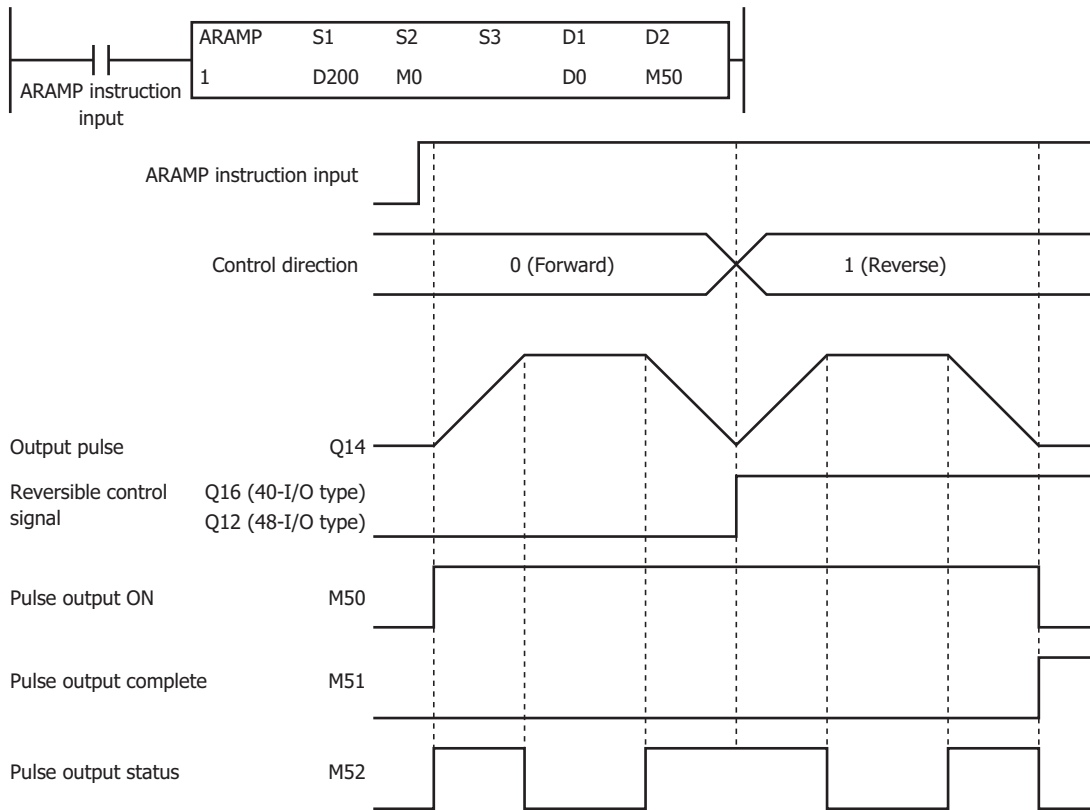

When the ARAMP instruction input changes from off to on, pulses are output from Q14 according to the settings configured by the data registers. The reversible control signal is output from Q16 or Q12. When pulse output starts, M50 turns on. M52 turns on while the pulse frequency is increasing or decreasing. The pulses increase and decrease according to the frequency change time until they reach the steady pulse frequency from the current pulse frequency. When the configured number of pulses are output, the pulses stop. In this situation, M50 turns off and M51 turns on.

If the ARAMP instruction input turns off during pulse output, pulse output ends. If this input turns on again, the operation starts from the beginning. Even if the contents of the data registers are changed during pulse output, the change is not reflected in the pulse output operation. The changed content is reflected the next time the ARAMP instruction is started.

Forward and reverse cannot be changed until the pulse output pulse frequency is set to its minimum. In mode 1 for example, forward and reverse cannot be changed until the pulse frequency is set to 200 Hz.

The changes from the initialization input are not reflected while the ARAMP1 instruction input is on. If you wish to initialize the data registers with the initialization input, turn the initialization input on after turning off the input.

19: PULSE OUTPUT INSTRUCTIONS

ARAMP1 instruction (dual-pulse output reversible control enabled) timing chart

[40-I/O type, ARAMP1 instruction, S1 is specified as data register D200, S2 is specified as internal relay M0, S3 is disabled, D1 is specified as data register D0, D2 is specified as internal relay M50]

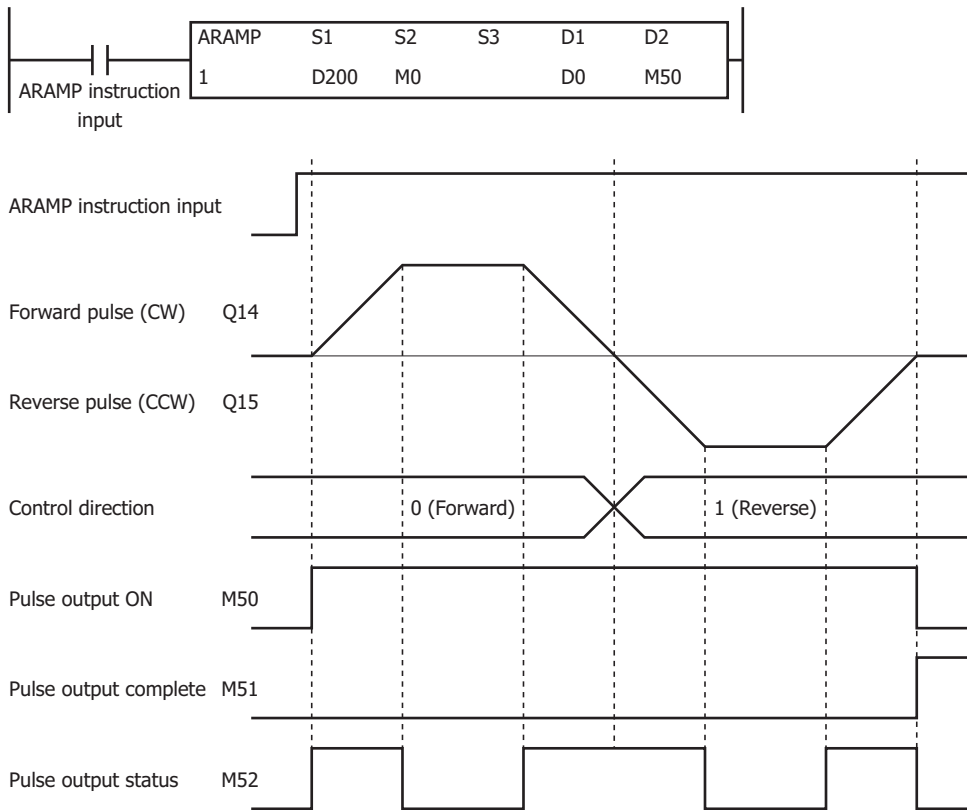

When the ARAMP instruction input changes from off to on, pulses are output from Q14 according to the settings configured by the data registers. The reversible control signal is output from Q14 or Q15. When pulse output starts, M50 turns on. M52 turns on while the pulse frequency is increasing or decreasing. The pulses increase and decrease according to the frequency change time until they reach the steady pulse frequency from the current pulse frequency. When the configured number of pulses are output, the pulses stop. In this situation, M50 turns off and M51 turns on.

If the ARAMP instruction input turns off during pulse output, pulse output ends. If the ARAMP instruction input turns on again, the operation starts from the beginning. Even if the contents of the data registers are changed during pulse output, the change is not reflected in the pulse output operation. The changed content is reflected the next time the ARAMP instruction is started.

Forward and reverse cannot be changed until the pulse output pulse frequency is set to its minimum.

The changes from the initialization input are not reflected while the ARAMP1 instruction input is on. If you wish to initialize the data registers with the initialization input, turn the initialization input on after turning off the ARAMP instruction input.

Sample program

This section describes an example program that outputs pulses as shown below with the frequency change function (reversible control disabled) using the following settings. The pulses are output from Q14.

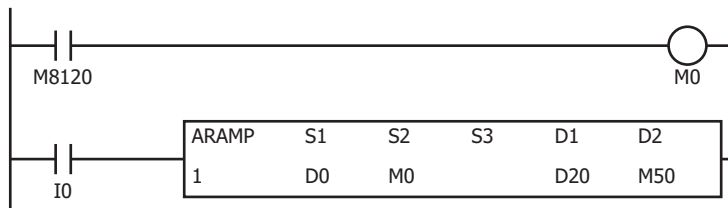
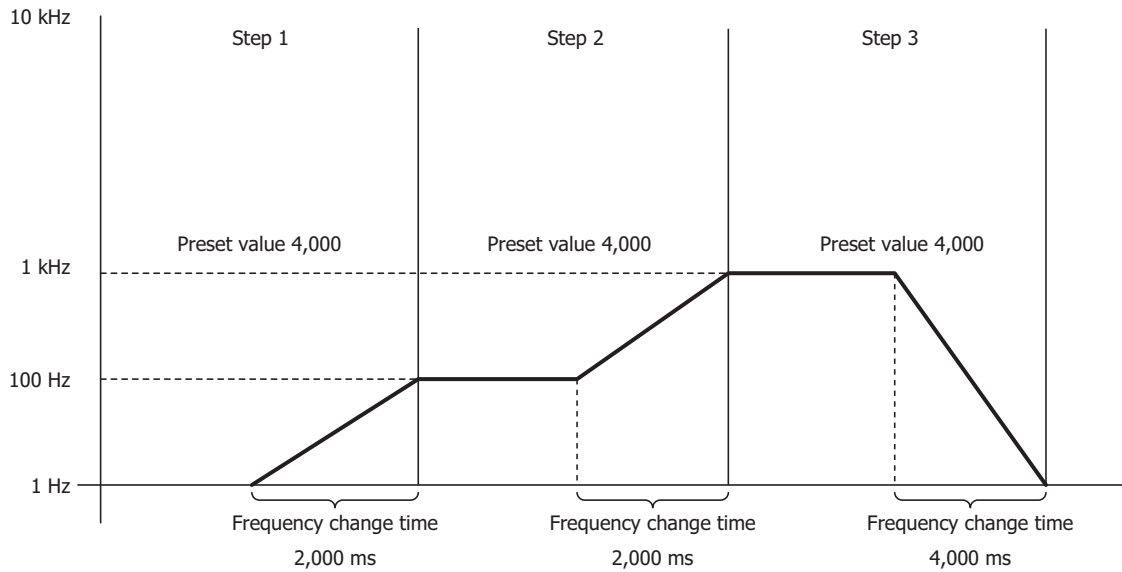

Initialize the data registers when the PLC starts

When the ARAMP instruction input (I0) turns on, pulse output starts

Basic settings

| Function | DR | Setting | Description |
|---------------------------|-------|------------------------|-----------------------------------|
| Operation mode | | Mode 0: 1 Hz to 10 kHz | 1 to 10,000 in increments of 1 Hz |
| Reversible control enable | | Disabled | |
| Number of steps | | 3 | 1 to 18 steps |
| Start step number | | 1 | 1 to 3 (step) |
| Interrupt step number | D0000 | 1 | 1 to 3 (step) |

| Function | Device address | Setting value | Details |
|---------------------------|----------------|---------------|----------------|
| Operation mode | — | Mode 0 | 1 Hz to 10 kHz |
| Reversible control enable | — | Disable | — |
| The number of steps | — | 3 | — |
| Start number | — | 1 | Step 1 |
| Interrupt number | D0 | — | — |

19: PULSE OUTPUT INSTRUCTIONS

Step 1 settings

| Function | DR | Setting | Description |
|-----------------------------------|--------------|---------------------------------|--------------------------------------|
| Steady pulse frequency | D0002 | 100 | 1 to 10,000 in increments of 1 Hz |
| Frequency change time | D0003 | 2000 | 10 to 10,000 in increments of 1 (ms) |
| Preset value | D0004, D0005 | 4000 | 1 to 100,000,000 |
| Control direction | D0006 | | |
| Acceleration/deceleration control | D0006 | Acceleration/deceleration later | |
| Next step number | D0007 | 2 | 0 to 3 (step) |

| Function | Device address | Setting value | Details |
|------------------------|----------------|---------------------------------|--------------------|
| Steady pulse frequency | D2 | 100 | 100 Hz |
| Frequency change time | D3 | 2000 | 2,000 ms |
| Preset value | D4, D5 | 4000 | Preset value=4,000 |
| Control direction | D6 | — | — |
| Timing of change | D6 | Acceleration/deceleration later | After |
| Next step number | D7 | 2 | Step 2 |

Step 2 settings

| Function | DR | Setting | Description |
|-----------------------------------|--------------|---------------------------------|--------------------------------------|
| Steady pulse frequency | D0008 | 1000 | 1 to 10,000 in increments of 1 Hz |
| Frequency change time | D0009 | 2000 | 10 to 10,000 in increments of 1 (ms) |
| Preset value | D0010, D0011 | 4000 | 1 to 100,000,000 |
| Control direction | D0012 | | |
| Acceleration/deceleration control | D0012 | Acceleration/deceleration later | |
| Next step number | D0013 | 3 | 0 to 3 (step) |

| Function | Device address | Setting value | Details |
|------------------------|----------------|---------------------------------|--------------------|
| Steady pulse frequency | D8 | 1000 | 1,000 Hz |
| Frequency change time | D9 | 2000 | 2,000 ms |
| Preset value | D10, D11 | 4000 | Preset value=4,000 |
| Control direction | D12 | — | — |
| Timing of change | D12 | Acceleration/deceleration later | After |
| Next step number | D13 | 3 | Step 3 |

Step 3 settings

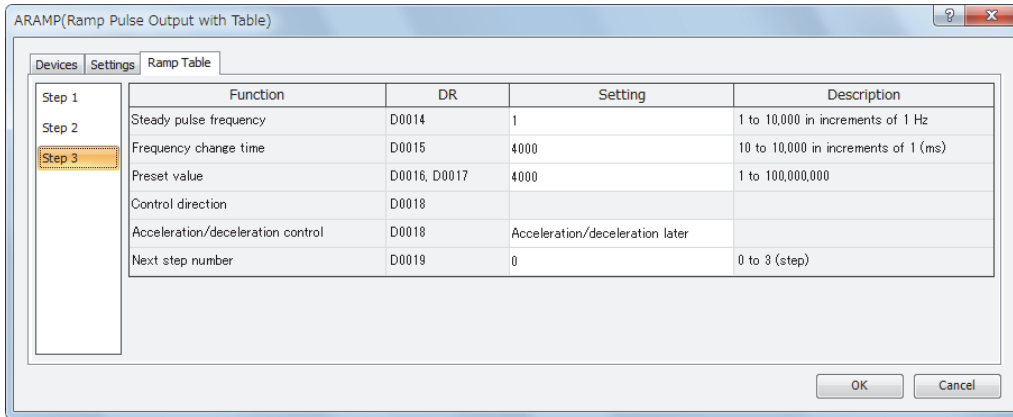

| Function | Device address | Setting value | Details |
|------------------------|----------------|---------------------------------|--------------------|
| Steady pulse frequency | D14 | 1 | 1 Hz |
| Frequency change time | D15 | 4000 | 4,000 ms |
| Preset value | D16, D17 | 4000 | Preset value=4,000 |
| Control direction | D18 | — | — |
| Timing of change | D18 | Acceleration/deceleration later | After |
| Next step number | D19 | 0 | 0=End output |

This section describes an example program that outputs pulses as shown below with the frequency change function (single-pulse output reversible control enabled) using the following settings.

The pulses are output from Q14.

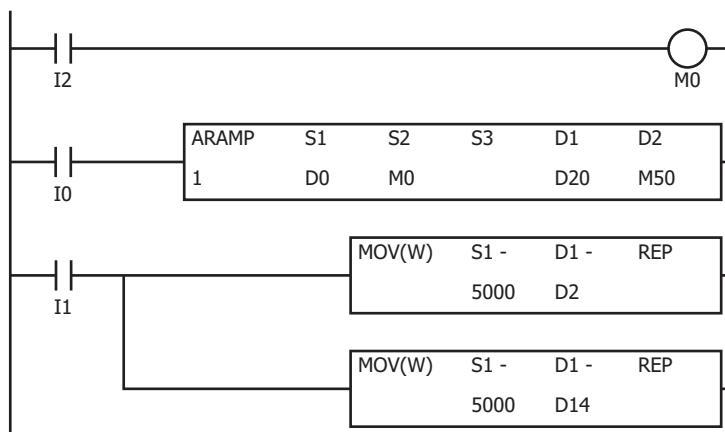
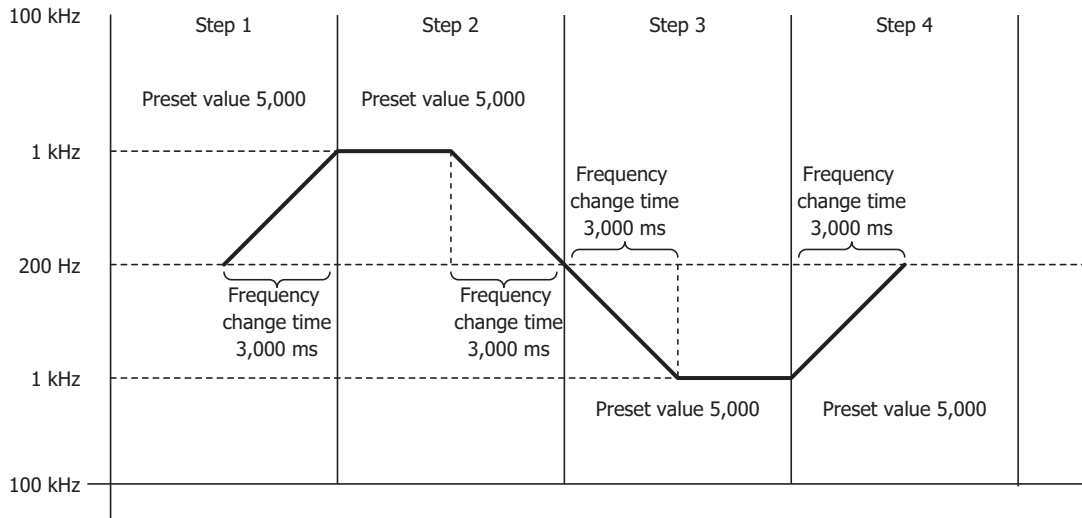

When I2 turns on, the initialization input (M0) is turned on and the ARAMP instruction control register values are initialized

When the ARAMP instruction input (I0) turns on, pulse output starts

When the MOV instruction input (I1) turns on, the steady pulse frequencies for step 2 and step 4 (D2 and D15) are changed to 5 kHz.

19: PULSE OUTPUT INSTRUCTIONS

Basic settings

The screenshot shows the ARAMP(Ramp Pulse Output with Table) software interface. The 'Settings' tab is active, displaying fields for S1 (Control Register), S2 (Initialization Input), S3 (Interrupt Input), D1 (Monitor Register), and D2 (Operation Status). The 'Ramp Table' tab is also visible, showing a table of parameters.

| Function | DR | Setting | Description |
|---------------------------|-------|---------------------------|--|
| Operation mode | | Mode 1: 200 Hz to 100 kHz | 20 to 10,000 in increments of 1 (x10 Hz) |
| Reversible control enable | | Single-pulse output | |
| Number of steps | | 4 | 1 to 18 steps |
| Start step number | | 1 | 1 to 4 (step) |
| Interrupt step number | D0000 | 1 | 1 to 4 (step) |

| Function | Device address | Setting value | Details |
|---------------------------|----------------|---------------------|-------------------|
| Operation mode | — | Mode 1 | 200 Hz to 100 kHz |
| Reversible control enable | — | Single-pulse output | — |
| The number of steps | — | 4 | — |
| Start number | — | 1 | Step 1 |
| Interrupt number | D0 | — | — |

Step 1 settings

The screenshot shows the ARAMP(Ramp Pulse Output with Table) software interface with the 'Step 1' settings tab selected. The table below shows the parameters for Step 1.

| Function | DR | Setting | Description |
|-----------------------------------|--------------|---------------------------------|--|
| Steady pulse frequency | D0002 | 100 | 20 to 10,000 in increments of 1 (x10 Hz) |
| Frequency change time | D0003 | 3000 | 10 to 10,000 in increments of 1 (ms) |
| Preset value | D0004, D0005 | 5000 | 1 to 100,000,000 |
| Control direction | D0006 | Forward | |
| Acceleration/deceleration control | D0006 | Acceleration/deceleration later | |
| Next step number | D0007 | 2 | 0 to 4 (step) |

| Function | Device address | Setting value | Details |
|------------------------|----------------|---------------------------------|--------------------|
| Steady pulse frequency | D2 | 100 | 1 kHz |
| Frequency change time | D3 | 3000 | 3,000 ms |
| Preset value | D4, D5 | 5000 | Preset value=5,000 |
| Control direction | D6 | Forward | Forward=0 |
| Timing of change | D6 | Acceleration/deceleration later | After=2 |
| Next step number | D7 | 2 | Step 2 |

Step 2 settings

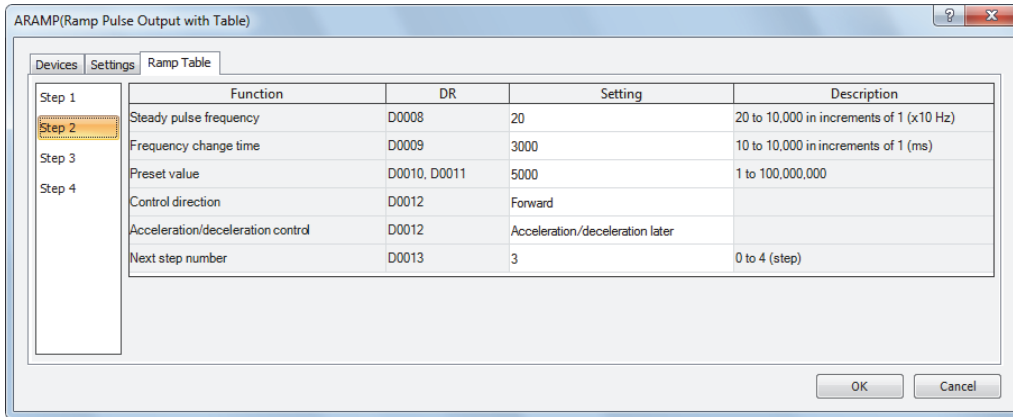

| Function | Device address | Setting value | Details |
|------------------------|----------------|---------------------------------|--------------------|
| Steady pulse frequency | D8 | 20 | 200 Hz |
| Frequency change time | D9 | 3000 | 3,000 ms |
| Preset value | D10, D11 | 5000 | Preset value=5,000 |
| Control direction | D12 | Forward | Forward=0 |
| Timing of change | D12 | Acceleration/deceleration later | After=2 |
| Next step number | D13 | 3 | Step 3 |

Step 3 settings

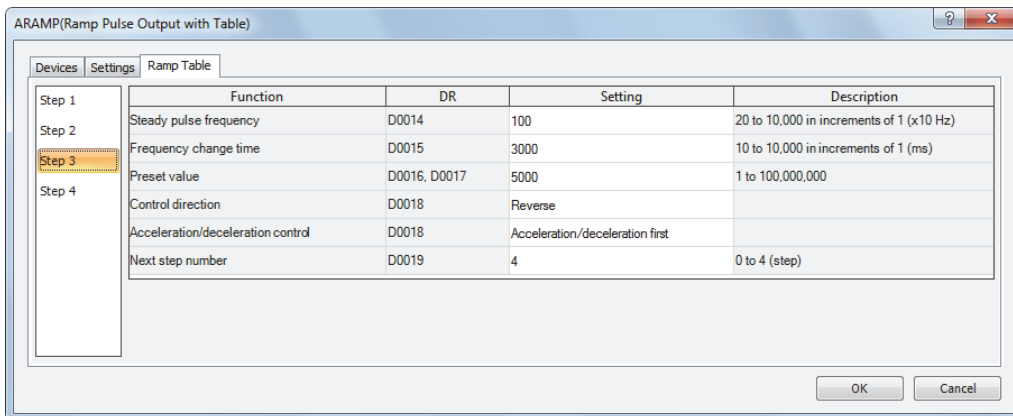

| Function | Device address | Setting value | Details |
|------------------------|----------------|---------------------------------|--------------------|
| Steady pulse frequency | D14 | 100 | 1 kHz |
| Frequency change time | D15 | 3000 | 3,000 ms |
| Preset value | D16, D17 | 5000 | Preset value=5,000 |
| Control direction | D18 | Reverse | Reverse=1 |
| Timing of change | D18 | Acceleration/deceleration first | Before=0 |
| Next step number | D19 | 4 | Step 4 |

19: PULSE OUTPUT INSTRUCTIONS

Step 4 settings

ARAMP(Ramp Pulse Output with Table)

Devices Settings Ramp Table

| Step | Function | DR | Setting | Description |
|--------|-----------------------------------|--------------|---------------------------------|--|
| Step 1 | Steady pulse frequency | D0020 | 20 | 20 to 10,000 in increments of 1 (x10 Hz) |
| Step 2 | Frequency change time | D0021 | 3000 | 10 to 10,000 in increments of 1 (ms) |
| Step 3 | Preset value | D0022, D0023 | 5000 | 1 to 100,000,000 |
| Step 4 | Control direction | D0024 | Reverse | |
| | Acceleration/deceleration control | D0024 | Acceleration/deceleration first | |
| | Next step number | D0025 | 0 | 0 to 4 (step) |

OK Cancel

| Function | Device address | Setting value | Details |
|------------------------|----------------|---------------------------------|--------------------|
| Steady pulse frequency | D20 | 20 | 200 Hz |
| Frequency change time | D21 | 3000 | 3,000 ms |
| Preset value | D22, D23 | 5000 | Preset value=5,000 |
| Control direction | D24 | Reverse | Reverse=1 |
| Timing of change | D24 | Acceleration/deceleration first | Before=0 |
| Next step number | D25 | 0 | Step 0 (end) |

This section describes an example program that outputs pulses as shown below with the frequency change function (single-pulse output reversible control disabled) using the following settings.

The pulses are output from Q14.

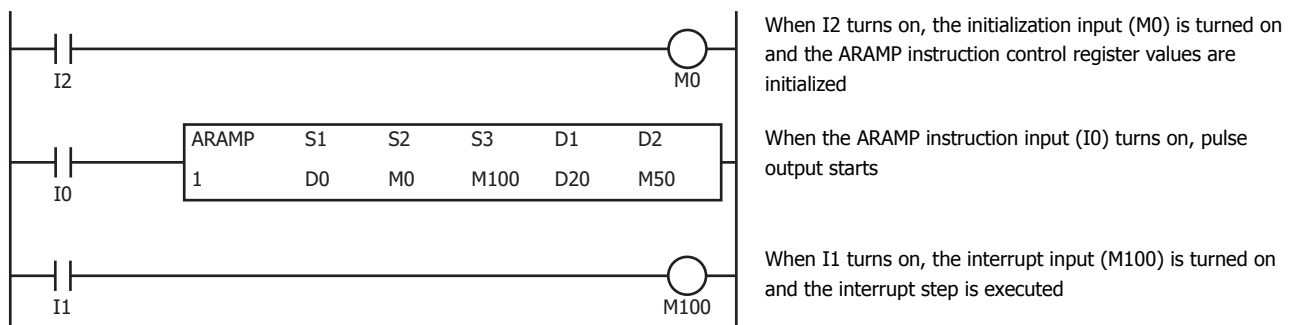
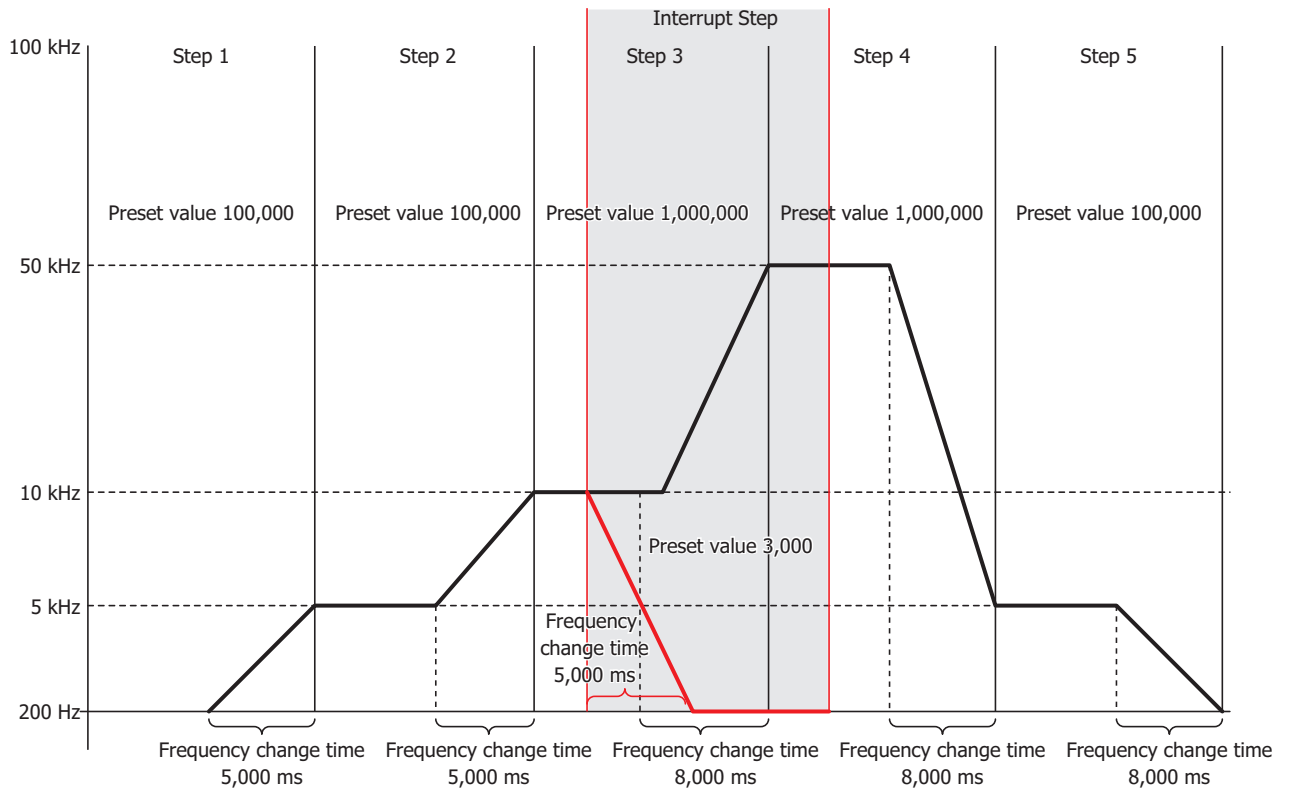

19: PULSE OUTPUT INSTRUCTIONS

Basic settings

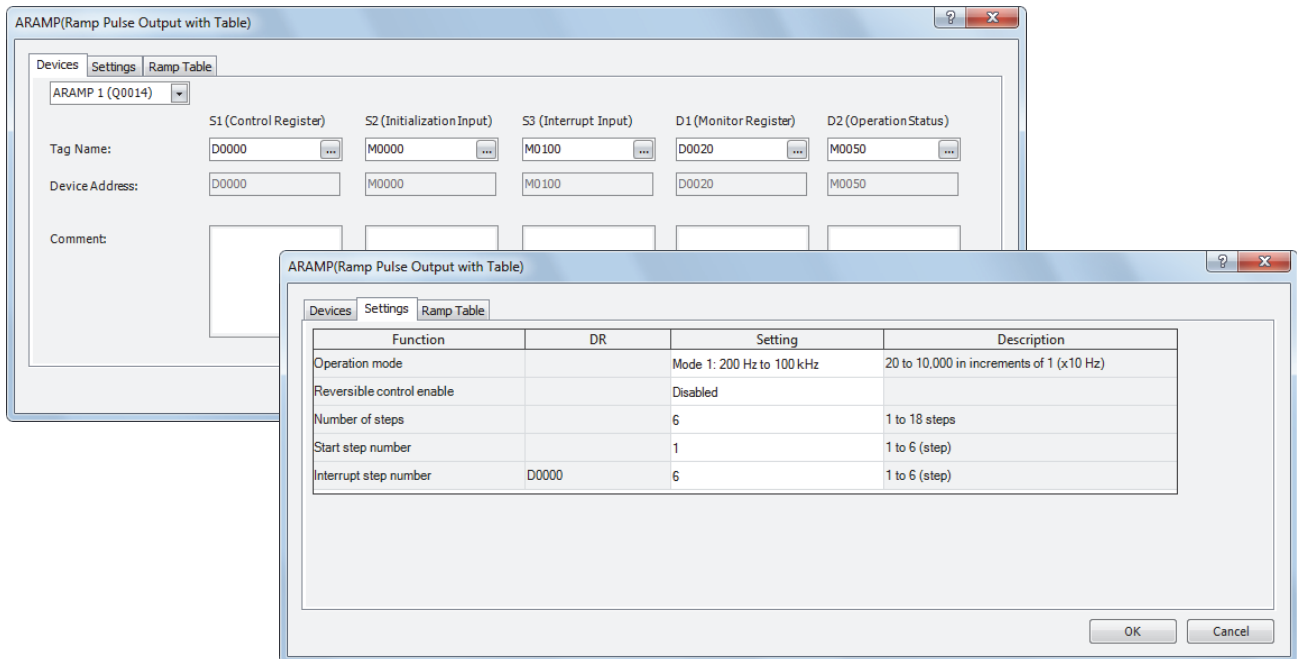

| Function | Device address | Setting value | Details |
|---------------------------|----------------|---------------|-------------------|
| Operation mode | — | Mode 1 | 200 Hz to 100 kHz |
| Reversible control enable | — | Disable | — |
| The number of steps | — | 6 | — |
| Start number | — | 1 | Step 1 |
| Interrupt number | D0 | 6 | Step 6 |

Step 1 settings

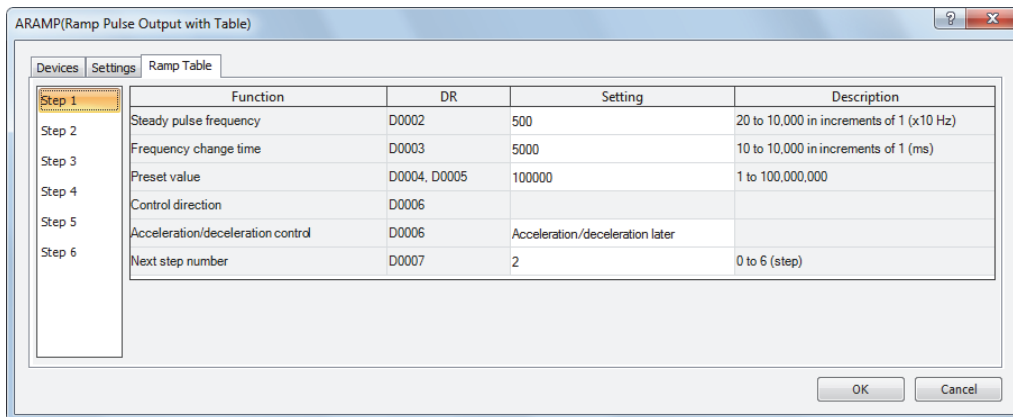

| Function | Device address | Setting value | Details |
|------------------------|----------------|---------------------------------|----------------------|
| Steady pulse frequency | D2 | 500 | 5 kHz |
| Frequency change time | D3 | 5000 | 5,000 ms |
| Preset value | D4, D5 | 100000 | Preset value=100,000 |
| Control direction | D6 | — | — |
| Timing of change | D6 | Acceleration/deceleration later | — |
| Next step number | D7 | 2 | Step 2 |

Step 2 settings

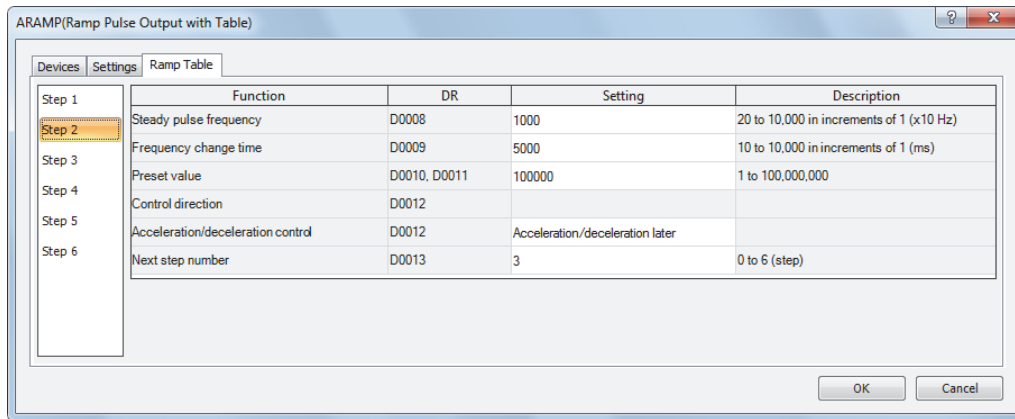

| Function | Device address | Setting value | Details |
|------------------------|----------------|---------------------------------|----------------------|
| Steady pulse frequency | D8 | 1000 | 10 kHz |
| Frequency change time | D9 | 5000 | 5,000 ms |
| Preset value | D10, D11 | 100000 | Preset value=100,000 |
| Control direction | D12 | — | — |
| Timing of change | D12 | Acceleration/deceleration later | — |
| Next step number | D13 | 3 | Step 3 |

Step 3 settings

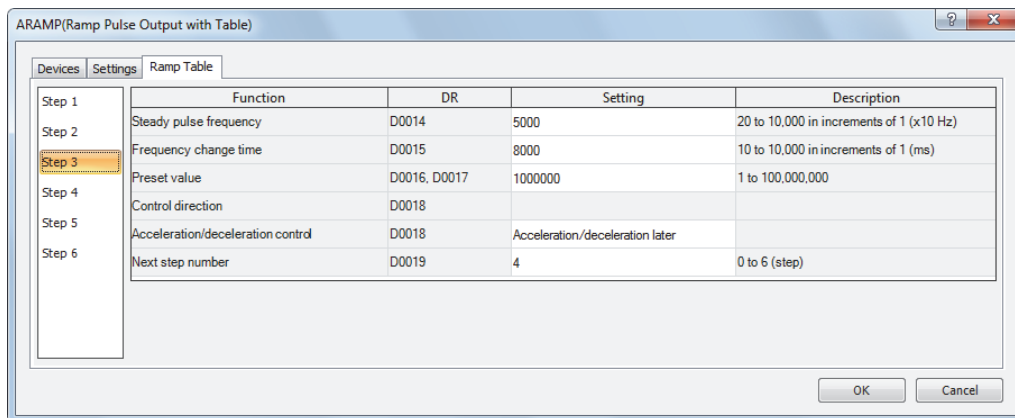

| Function | Device address | Setting value | Details |
|------------------------|----------------|---------------------------------|------------------------|
| Steady pulse frequency | D14 | 5000 | 50 kHz |
| Frequency change time | D15 | 8000 | 8,000 ms |
| Preset value | D16, D17 | 1000000 | Preset value=1,000,000 |
| Control direction | D18 | — | — |
| Timing of change | D18 | Acceleration/deceleration later | — |
| Next step number | D19 | 4 | Step 4 |

19: PULSE OUTPUT INSTRUCTIONS

Step 4 settings

| Step | Function | DR | Setting | Description |
|---------------|-----------------------------------|--------------|---------------------------------|--|
| Step 1 | Steady pulse frequency | D0020 | 500 | 20 to 10,000 in increments of 1 (x10 Hz) |
| Step 2 | Frequency change time | D0021 | 8000 | 10 to 10,000 in increments of 1 (ms) |
| Step 3 | Preset value | D0022, D0023 | 1000000 | 1 to 100,000,000 |
| Step 4 | Control direction | D0024 | | |
| Step 5 | Acceleration/deceleration control | D0024 | Acceleration/deceleration later | |
| Step 6 | Next step number | D0025 | 5 | 0 to 6 (step) |

| Function | Device address | Setting value | Details |
|------------------------|----------------|---------------------------------|------------------------|
| Steady pulse frequency | D20 | 500 | 5 kHz |
| Frequency change time | D21 | 8000 | 8,000 ms |
| Preset value | D22, D23 | 1000000 | Preset value=1,000,000 |
| Control direction | D24 | — | — |
| Timing of change | D24 | Acceleration/deceleration later | — |
| Next step number | D25 | 5 | Step 5 |

Step 5 settings

| Step | Function | DR | Setting | Description |
|---------------|--|--------------|---------|--|
| Step 1 | Steady pulse frequency | D0026 | 20 | 20 to 10,000 in increments of 1 (x10 Hz) |
| Step 2 | Frequency change time | D0027 | 8000 | 10 to 10,000 in increments of 1 (ms) |
| Step 3 | Preset value | D0028, D0029 | 100000 | 1 to 100,000,000 |
| Step 4 | Control direction | D0030 | | |
| Step 5 | Acceleration/deceleration control | D0030 | | |
| Step 6 | Next step number | D0031 | 0 | 0 to 6 (step) |

| Function | Device address | Setting value | Details |
|------------------------|----------------|---------------------------------|----------------------|
| Steady pulse frequency | D26 | 20 | 200 Hz |
| Frequency change time | D27 | 8000 | 8,000 ms |
| Preset value | D28, D29 | 100000 | Preset value=100,000 |
| Control direction | D30 | — | — |
| Timing of change | D30 | Acceleration/deceleration later | — |
| Next step number | D31 | 0 | 0=End output |

Step 6 settings

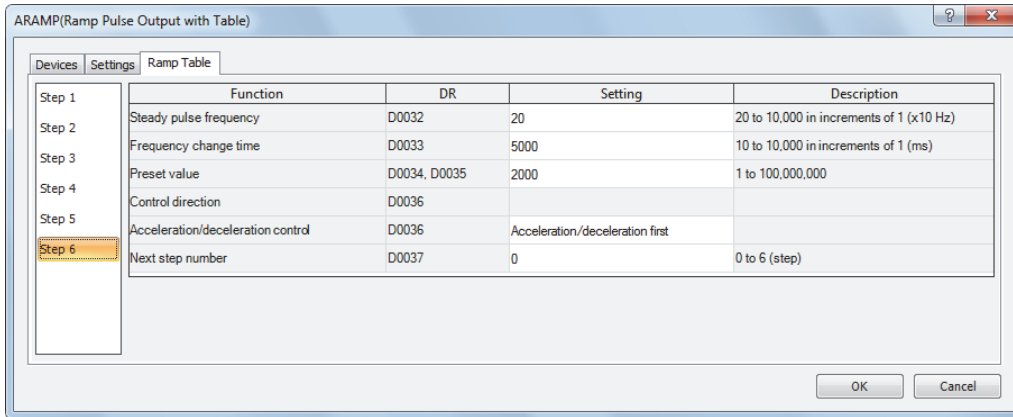

| Function | Device address | Setting value | Details |
|------------------------|----------------|---------------------------------|--------------------|
| Steady pulse frequency | D32 | 20 | 200 Hz |
| Frequency change time | D33 | 5000 | 5000 ms |
| Preset value | D34, D35 | 2000 | Preset value=2,000 |
| Control direction | D36 | — | — |
| Timing of change | D36 | Acceleration/deceleration first | Before=0 |
| Next step number | D37 | 0 | 0=End output |

20: DUAL / TEACHING TIMER INSTRUCTIONS

Introduction

Dual timer instructions generate ON/OFF pulses of required durations from a designated output, internal relay, or shift register bit. Four dual timers are available and the ON/OFF duration can be selected from 1 ms up to 65535 sec.

Teaching timer instruction measures the ON duration of the start input for the teaching timer instruction and stores the measured data to a designated data register, which can be used as a preset value for a timer instruction.

DTML (1-sec Dual Timer)



While input is on, destination device D1 repeats to turn on and off for a duration assigned by devices S1 and S2, respectively.

When the input is off, D1 turns off.

The time range is 0 through 65535 sec.

DTIM (100-ms Dual Timer)

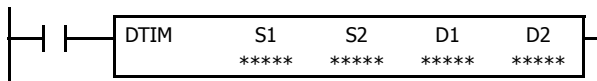

While input is on, destination device D1 repeats to turn on and off for a duration assigned by devices S1 and S2, respectively.

When the input is off, D1 turns off.

The time range is 0 through 6553.5 sec.

DTMH (10-ms Dual Timer)

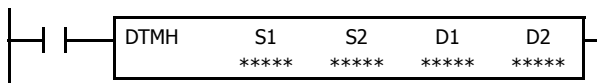

While input is on, destination device D1 repeats to turn on and off for a duration assigned by devices S1 and S2, respectively.

When the input is off, D1 turns off.

The time range is 0 through 655.35 sec.

DTMS (1-ms Dual Timer)

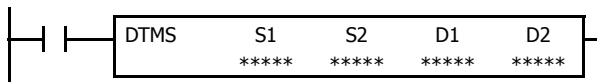

While input is on, destination device D1 repeats to turn on and off for a duration assigned by devices S1 and S2, respectively.

When the input is off, D1 turns off.

The time range is 0 through 65.535 sec.

Applicable SmartAXIS

| FT1A-12 | FT1A-24 | FT1A-40 | FT1A-48 | FT1A-Touch |
|---------|---------|---------|---------|------------|
| X | X | X | X | X |

20: DUAL / TEACHING TIMER INSTRUCTIONS

Valid Devices

| Device | Function | I | Q | M | R | T | C | D | Constant |
|--------------------|-------------------|---|---|---|---|---|---|---|----------|
| S1 (Source 1) | ON duration | — | — | — | — | — | — | X | 0-65535 |
| S2 (Source 2) | OFF duration | — | — | — | — | — | — | X | 0-65535 |
| D1 (Destination 1) | Dual timer output | — | X | ▲ | X | — | — | — | — |
| D2 (Destination 2) | System work area | — | — | — | — | — | — | X | — |

For valid device address ranges, see "Device Addresses" on page 3-1.

▲ Internal relays M0 through M1277 can be designated as D1. Special internal relays cannot be designated as D1.

Destination device D2 (system work area) uses 2 data registers starting with the device designated as D2. Data registers D0-D998 and D1000-D1998 can be designated as D2. The two data registers are used for a system work area. Do not use these data registers for destinations of other advanced instructions, and do not change values of these data registers using the monitor function on WindLDR. If the data in these data registers are changed, the dual timer does not operate correctly.

The dual timer instructions cannot be used in an interrupt program. If used, a user program execution error will result, turning on special internal relay M8004 and the ERR LED on the SmartAXIS.

When a user program execution error occurs, the execution of the instruction is canceled and the next instruction is executed. The data in D1 (destination 1) is unchanged. For details about the user program execution errors, see "User Program Execution Errors" on page 4-13.

Examples: DTML, DTIM, DTMH, DTMS

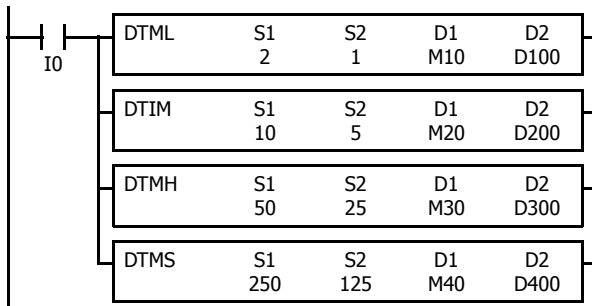

While input I0 is on, four dual timer instructions turn on and off the destination devices according to the on and off durations assigned by source devices S1 and S2.

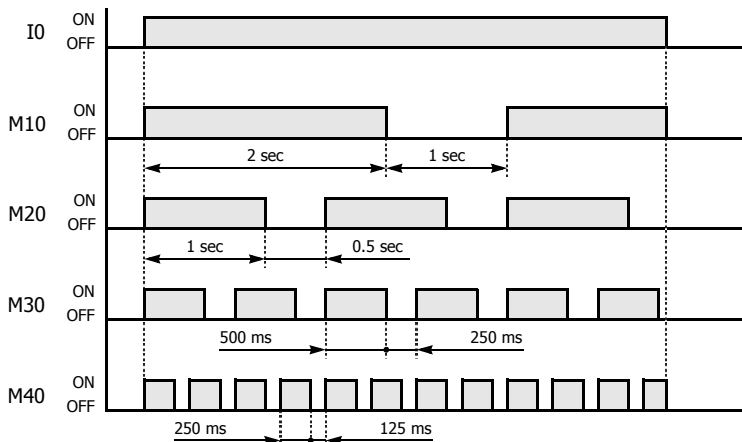

| Instruction | Increments | S1 | ON duration | S2 | OFF duration |
|-------------|------------|-----|---------------------|-----|----------------------|
| DTML | 1 sec | 2 | 1 sec × 2 = 2 sec | 1 | 1 sec × 1 = 1 sec |
| DTIM | 100 ms | 10 | 100 ms × 10 = 1 sec | 5 | 100 ms × 5 = 0.5 sec |
| DTMH | 10 ms | 50 | 10 ms × 50 = 500 ms | 25 | 10 ms × 25 = 250 ms |
| DTMS | 1 ms | 250 | 1 ms × 250 = 250 ms | 125 | 1 ms × 125 = 125 ms |

For the timer accuracy of timer instructions, see "TML, TIM, TMH, and TMS (Timer)" on page 5-7.

TTIM (Teaching Timer)

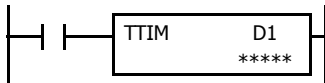

While input is on, the ON duration is measured in units of 100 ms and the measured value is stored to a data register assigned by destination device D1.

When the input is off, D1 turns off.

The measured time range is 0 through 6553.5 sec.

Applicable SmartAXIS

| FT1A-12 | FT1A-24 | FT1A-40 | FT1A-48 | FT1A-Touch |
|---------|---------|---------|---------|------------|
| X | X | X | X | X |

Valid Devices

| Device | Function | I | Q | M | R | T | C | D | Constant |
|--------------------|----------------|---|---|---|---|---|---|---|----------|
| D1 (Destination 1) | Measured value | — | — | — | — | — | — | X | — |

For valid device address ranges, see "Device Addresses" on page 3-1.

Destination device D1 (measured value) uses 3 data registers starting with the device designated as D1. Data registers D0-D997 and D1000-D1997 can be designated as D1. Subsequent two data registers starting with destination device D1+1 are used for a system work area. Do not use these two data registers for destinations of other advanced instructions, and do not change values of these data registers using the monitor function on WindLDR. If the data in these data registers are changed, the teaching timer does not operate correctly.

The teaching timer instruction cannot be used in an interrupt program. If used, a user program execution error will result, turning on special internal relay M8004 and the ERR LED on the SmartAXIS. For details about the user program execution errors, see "User Program Execution Errors" on page 4-13.

When a user program execution error occurs, the execution of the instruction is canceled and the next instruction is executed. The data in D1 (destination 1) is unchanged. For details about the user program execution errors, see "User Program Execution Errors" on page 4-13.

Examples: TTIM

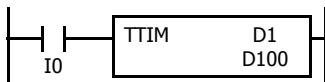

When input I0 is turned on, TTIM resets data register D100 to zero and starts to store the ON duration of input I0 to data register D100, measured in units of 100 ms.

When input I0 is turned off, TTIM stops the measurement, and data register D100 maintains the measured value of the ON duration.

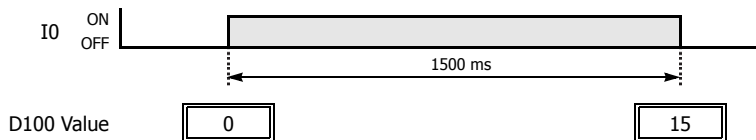

The following example demonstrates a program to measure the ON duration of input I0 and to use the ON duration as a preset value for 100-ms timer instruction TIM.

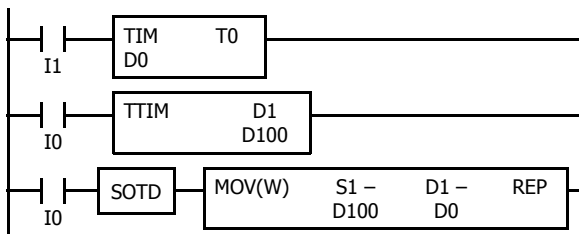

When input I1 is turned on, 100-ms timer T0 starts to operate with a preset value stored in data register D0.

While input I0 is on, TTIM measures the ON duration of input I0 and stores the measured value in units of 100 ms to data register D100.

When input I0 is turned off, MOV(W) stores the D100 value to data register D0 as a preset value for timer T0.

21: TRIGONOMETRIC FUNCTION INSTRUCTIONS

Introduction

Trigonometric function instructions are used for conversion between radian and degree values, conversion from radian value to sine, cosine, and tangent, and also calculation of arc sine, arc cosine, and arc tangent values.

RAD (Degree to Radian)

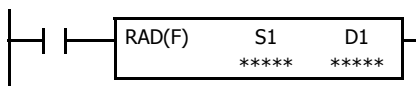

$$S1 \cdot S1 + 1^\circ \times \pi / 180 \rightarrow D1 \cdot D1 + 1 \text{ rad}$$

When input is on, the degree value assigned by source device S1 is converted into a radian value and stored to the destination assigned by device D1.

Applicable SmartAXIS

| FT1A-12 | FT1A-24 | FT1A-40 | FT1A-48 | FT1A-Touch |
|---------|---------|---------|---------|------------|
| X | X | X | X | X |

Valid Devices

| Device | Function | I | Q | M | R | T | C | D | Constant | Repeat |
|--------------------|---|---|---|---|---|---|---|---|----------|--------|
| S1 (Source 1) | Degree value to convert into radian | — | — | — | — | — | — | X | X | — |
| D1 (Destination 1) | Destination to store conversion results | — | — | — | — | — | — | X | — | — |

For the valid device address range, see "Device Addresses" on page 3-1.

When the conversion result is not within the range between -3.402823×10^{38} and $-1.175495 \times 10^{-38}$ or between 1.175495×10^{-38} and 3.402823×10^{38} , special internal relay M8003 (carry or borrow) is turned on except when the conversion result is 0. When the conversion result is between $-1.175495 \times 10^{-38}$ and 1.175495×10^{-38} , the destination device designated by D1 stores 0.

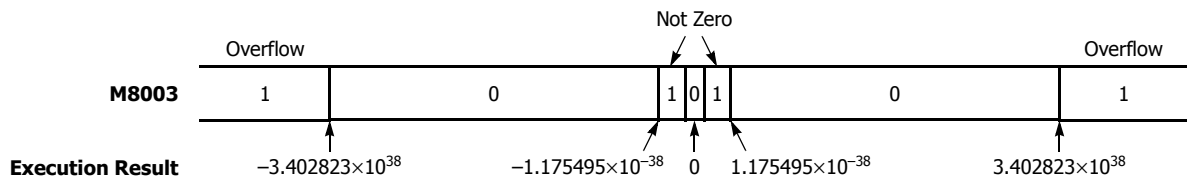

When the data designated by S1 does not comply with the normal floating-point format, a user program execution error will result, turning on special internal relay M8004 and ERR LED on the SmartAXIS. For details about the user program execution errors, see "User Program Execution Errors" on page 4-13.

Since the RAD instruction is executed in each scan while input is on, a pulse input from a SOTU or SOTD instruction should be used.

Valid Data Types

| | |
|-----------------|---|
| W (word) | — |
| I (integer) | — |
| D (double word) | — |
| L (long) | — |
| F (float) | X |

Since floating point data is used, the source and destination devices use two consecutive data registers.

Example: RAD

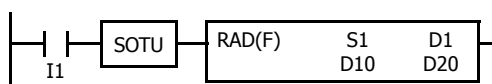

When input I1 is turned on, the degree value of data registers D10 and D11 assigned by source device S1 is converted into a radian value and stored to data registers D20 and D21 assigned by destination device D1.

$$270^\circ \times \pi / 180 \rightarrow 4.712389 \text{ rad}$$

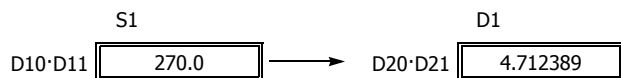

21: TRIGONOMETRIC FUNCTION INSTRUCTIONS

DEG (Radian to Degree)

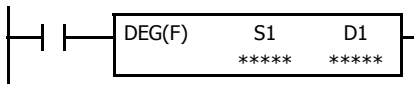

$$S1 \cdot S1+1 \text{ rad} \times 180/\pi \rightarrow D1 \cdot D1+1^\circ$$

When input is on, the radian value assigned by source device S1 is converted into a degree value and stored to the destination assigned by device D1.

Applicable SmartAXIS

| FT1A-12 | FT1A-24 | FT1A-40 | FT1A-48 | FT1A-Touch |
|---------|---------|---------|---------|------------|
| X | X | X | X | X |

Valid Devices

| Device | Function | I | Q | M | R | T | C | D | Constant | Repeat |
|--------------------|---|---|---|---|---|---|---|---|----------|--------|
| S1 (Source 1) | Radian value to convert into degree | — | — | — | — | — | — | X | X | — |
| D1 (Destination 1) | Destination to store conversion results | — | — | — | — | — | — | X | — | — |

For valid device address ranges, see "Device Addresses" on page 3-1.

When the conversion result is not within the range between -3.402823×10^{38} and $-1.175495 \times 10^{-38}$ or between 1.175495×10^{-38} and 3.402823×10^{38} , special internal relay M8003 (carry or borrow) is turned on except when the conversion result is 0. When the conversion result is below -3.402823×10^{38} or over 3.402823×10^{38} , causing an overflow, the destination device designated by D1 stores a value of minus or plus infinity.

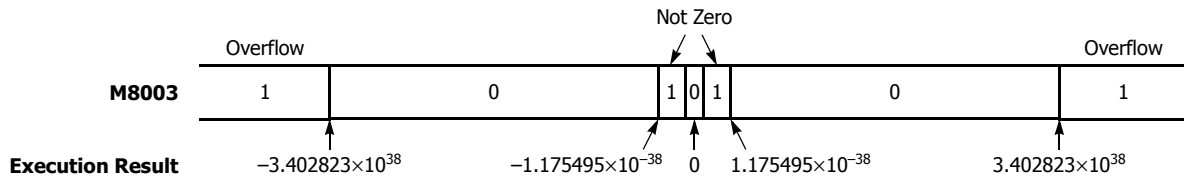

When the data designated by S1 does not comply with the normal floating-point format, a user program execution error will result, turning on special internal relay M8004 and ERR LED on the SmartAXIS. For details about the user program execution errors, see "User Program Execution Errors" on page 4-13.

Since the DEG instruction is executed in each scan while input is on, a pulse input from a SOTU or SOTD instruction should be used.

Valid Data Types

| | |
|-----------------|---|
| W (word) | — |
| I (integer) | — |
| D (double word) | — |
| L (long) | — |
| F (float) | X |

Since floating point data is used, the source and destination devices use two consecutive data registers.

Example: DEG

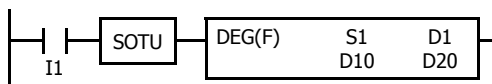

When input I1 is turned on, the radian value of data registers D10 and D11 assigned by source device S1 is converted into a degree value and stored to data registers D20 and D21 assigned by destination device D1.

$$4.712389 \text{ rad} \times 180/\pi \rightarrow 270.0^\circ$$

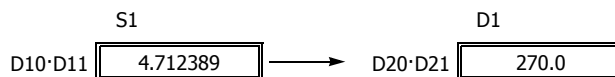

SIN (Sine)



$\sin S1 \cdot S1+1 \rightarrow D1 \cdot D1+1$

When input is on, the sine of the radian value assigned by source device S1 is stored to the destination assigned by device D1.

Applicable SmartAXIS

| FT1A-12 | FT1A-24 | FT1A-40 | FT1A-48 | FT1A-Touch |
|---------|---------|---------|---------|------------|
| X | X | X | X | X |

Valid Devices

| Device | Function | I | Q | M | R | T | C | D | Constant | Repeat |
|--------------------|---|---|---|---|---|---|---|---|----------|--------|
| S1 (Source 1) | Radian value to convert into sine value | — | — | — | — | — | — | X | X | — |
| D1 (Destination 1) | Destination to store conversion results | — | — | — | — | — | — | X | — | — |

For valid device address ranges, see "Device Addresses" on page 3-1.

When the data designated by S1 does not comply with the normal floating-point format, a user program execution error will result, turning on special internal relay M8004 and ERR LED on the SmartAXIS. For details about the user program execution errors, see "User Program Execution Errors" on page 4-13.

Since the SIN instruction is executed in each scan while input is on, a pulse input from a SOTU or SOTD instruction should be used.

Valid Data Types

| | |
|------------------------|---|
| W (word) | — |
| I (integer) | — |
| D (double word) | — |
| L (long) | — |
| F (float) | X |

Since the floating point data type is used, the source and destination devices use two consecutive data registers.

Example: SIN

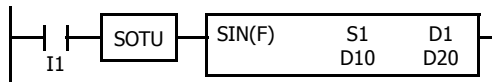

When input I1 is turned on, the sine of the radian value of data registers D10 and D11 assigned by source device S1 is stored to data registers D20 and D21 assigned by destination device D1.

$3.926991 \text{ rad} = 5\pi/4 \text{ rad}$

$\sin 5\pi/4 \rightarrow -0.7071069$

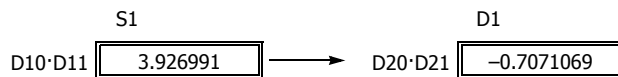

21: TRIGONOMETRIC FUNCTION INSTRUCTIONS

COS (Cosine)

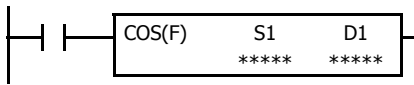

$\cos S1 \cdot S1+1 \rightarrow D1 \cdot D1+1$

When input is on, the cosine of the radian value assigned by source device S1 is stored to the destination assigned by device D1.

Applicable SmartAXIS

| FT1A-12 | FT1A-24 | FT1A-40 | FT1A-48 | FT1A-Touch |
|---------|---------|---------|---------|------------|
| X | X | X | X | X |

Valid Devices

| Device | Function | I | Q | M | R | T | C | D | Constant | Repeat |
|--------------------|---|---|---|---|---|---|---|---|----------|--------|
| S1 (Source 1) | Radian value to convert into cosine value | — | — | — | — | — | — | X | X | — |
| D1 (Destination 1) | Destination to store conversion results | — | — | — | — | — | — | X | — | — |

For valid device address ranges, see "Device Addresses" on page 3-1.

When the data designated by S1 does not comply with the normal floating-point format, a user program execution error will result, turning on special internal relay M8004 and ERR LED on the SmartAXIS. For details about the user program execution errors, see "User Program Execution Errors" on page 4-13.

Since the COS instruction is executed in each scan while input is on, a pulse input from a SOTU or SOTD instruction should be used.

Valid Data Types

| | |
|-----------------|---|
| W (word) | — |
| I (integer) | — |
| D (double word) | — |
| L (long) | — |
| F (float) | X |

Since floating point data is used, the source and destination devices use two consecutive data registers.

Example: COS

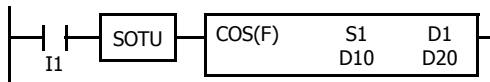

When input I1 is turned on, the cosine of the radian value of data registers D10 and D11 assigned by source device S1 is stored to data registers D20 and D21 assigned by destination device D1.

$$3.926991 \text{ rad} = 5\pi/4 \text{ rad}$$

$$\cos 5\pi/4 \rightarrow -0.7071068$$

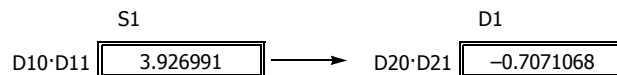

TAN (Tangent)

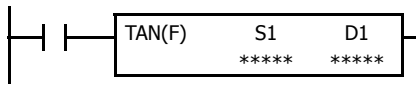

$\tan S1 \cdot S1+1 \rightarrow D1 \cdot D1+1$

When input is on, the tangent of the radian value assigned by source device S1 is stored to the destination assigned by device D1.

Applicable SmartAXIS

| FT1A-12 | FT1A-24 | FT1A-40 | FT1A-48 | FT1A-Touch |
|---------|---------|---------|---------|------------|
| X | X | X | X | X |

Valid Devices

| Device | Function | I | Q | M | R | T | C | D | Constant | Repeat |
|--------------------|--|---|---|---|---|---|---|---|----------|--------|
| S1 (Source 1) | Radian value to convert into tangent value | — | — | — | — | — | — | X | X | — |
| D1 (Destination 1) | Destination to store conversion results | — | — | — | — | — | — | X | — | — |

For valid device address ranges, see "Device Addresses" on page 3-1.

When the conversion result is not within the range between -3.402823×10^{38} and $-1.175495 \times 10^{-38}$ or between 1.175495×10^{-38} and 3.402823×10^{38} , special internal relay M8003 (carry or borrow) is turned on except when the conversion result is 0. When the conversion result is below -3.402823×10^{38} or over 3.402823×10^{38} , causing an overflow, the destination device designated by D1 stores a value of minus or plus infinity.

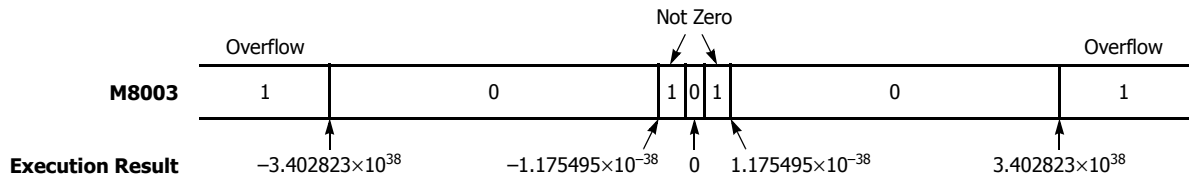

When the data designated by S1 does not comply with the normal floating-point format, a user program execution error will result, turning on special internal relay M8004 and ERR LED on the SmartAXIS. For details about the user program execution errors, see "User Program Execution Errors" on page 4-13.

Since the TAN instruction is executed in each scan while input is on, a pulse input from a SOTU or SOTD instruction should be used.

Valid Data Types

| | |
|-----------------|---|
| W (word) | — |
| I (integer) | — |
| D (double word) | — |
| L (long) | — |
| F (float) | X |

Since floating point data is used, the source and destination devices use two consecutive data registers.

Example: TAN

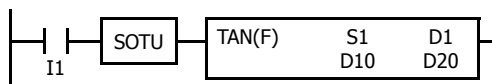

When input I1 is turned on, the tangent of the radian value of data registers D10 and D11 assigned by source device S1 is stored to data registers D20 and D21 assigned by destination device D1.

$$3.926991 \text{ rad} = 5\pi/4 \text{ rad}$$

$$\tan 5\pi/4 \rightarrow 1.000001$$

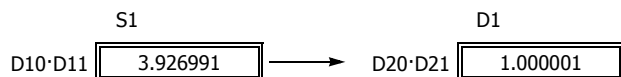

21: TRIGONOMETRIC FUNCTION INSTRUCTIONS

ASIN (Arc Sine)

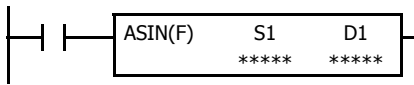

asin S1·S1+1 → D1·D1+1 rad

When input is on, the arc sine of the value assigned by source device S1 is stored in radians to the destination assigned by device D1.

The S1·S1+1 value must be within the following range:

$$-1.0 \leq S1 \cdot S1+1 \leq 1.0$$

If the S1·S1+1 value is not within this range, 0 is stored to D1·D1+1.

Applicable SmartAXIS

| FT1A-12 | FT1A-24 | FT1A-40 | FT1A-48 | FT1A-Touch |
|---------|---------|---------|---------|------------|
| X | X | X | X | X |

Valid Devices

| Device | Function | I | Q | M | R | T | C | D | Constant | Repeat |
|--------------------|---|---|---|---|---|---|---|---|----------|--------|
| S1 (Source 1) | Arc sine value to convert into radian | — | — | — | — | — | — | X | X | — |
| D1 (Destination 1) | Destination to store conversion results | — | — | — | — | — | — | X | — | — |

For valid device address ranges, see "Device Addresses" on page 3-1.

When the data designated by source device S1 is not within the range between -1.0 and 1.0 or does not comply with the normal floating-point format, a user program execution error will result, turning on special internal relay M8004 and ERR LED on the SmartAXIS. For details about the user program execution errors, see "User Program Execution Errors" on page 4-13.

Since the ASIN instruction is executed in each scan while input is on, a pulse input from a SOTU or SOTD instruction should be used.

Valid Data Types

| | |
|------------------------|---|
| W (word) | — |
| I (integer) | — |
| D (double word) | — |
| L (long) | — |
| F (float) | X |

Since floating point data is used, the source and destination devices use two consecutive data registers.

Example: ASIN

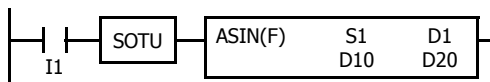

When input I1 is turned on, the arc sine of the value of data registers D10 and D11 assigned by source device S1 is stored to data registers D20 and D21 assigned by destination device D1.

$$\text{asin } -0.7071069 \rightarrow -0.7853982 \text{ rad}$$

$$-0.7853982 \text{ rad} = -\pi/4 \text{ rad}$$



ACOS (Arc Cosine)

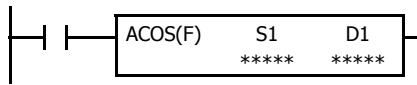

$\text{acos } S1 \cdot S1+1 \rightarrow D1 \cdot D1+1 \text{ rad}$

When input is on, the arc cosine of the value assigned by source device S1 is stored in radians to the destination assigned by device D1.

The S1·S1+1 value must be within the following range:

$$-1.0 \leq S1 \cdot S1+1 \leq 1.0$$

If the S1·S1+1 value is not within this range, 0 is stored to D1·D1+1.

Applicable SmartAXIS

| FT1A-12 | FT1A-24 | FT1A-40 | FT1A-48 | FT1A-Touch |
|---------|---------|---------|---------|------------|
| X | X | X | X | X |

Valid Devices

| Device | Function | I | Q | M | R | T | C | D | Constant | Repeat |
|--------------------|---|---|---|---|---|---|---|---|----------|--------|
| S1 (Source 1) | Arc cosine value to convert into radian | — | — | — | — | — | — | X | X | — |
| D1 (Destination 1) | Destination to store conversion results | — | — | — | — | — | — | X | — | — |

For valid device address ranges, see "Device Addresses" on page 3-1.

When the data designated by source device S1 is not within the range between -1.0 and 1.0 or does not comply with the normal floating-point format, a user program execution error will result, turning on special internal relay M8004 and ERR LED on the SmartAXIS. For details about the user program execution errors, see "User Program Execution Errors" on page 4-13.

Since the ACOS instruction is executed in each scan while input is on, a pulse input from a SOTU or SOTD instruction should be used.

Valid Data Types

| | |
|-----------------|---|
| W (word) | — |
| I (integer) | — |
| D (double word) | — |
| L (long) | — |
| F (float) | X |

Since floating point data is used, the source and destination devices use two consecutive data registers.

Example: ACOS



When input I1 is turned on, the arc cosine of the value of data registers D10 and D11 assigned by source device S1 is stored to data registers D20 and D21 assigned by destination device D1.

$$\text{acos } -0.7071068 \rightarrow 2.356195 \text{ rad}$$

$$2.356195 \text{ rad} = 3\pi/4 \text{ rad}$$

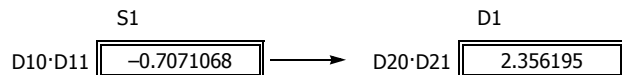

21: TRIGONOMETRIC FUNCTION INSTRUCTIONS

ATAN (Arc Tangent)

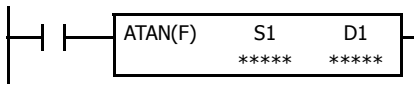

atan S1·S1+1 → D1·D1+1 rad

When input is on, the arc tangent of the value assigned by source device S1 is stored in radians to the destination assigned by device D1.

Applicable SmartAXIS

| FT1A-12 | FT1A-24 | FT1A-40 | FT1A-48 | FT1A-Touch |
|---------|---------|---------|---------|------------|
| X | X | X | X | X |

Valid Devices

| Device | Function | I | Q | M | R | T | C | D | Constant | Repeat |
|--------------------|--|---|---|---|---|---|---|---|----------|--------|
| S1 (Source 1) | Arc tangent value to convert into radian | — | — | — | — | — | — | X | X | — |
| D1 (Destination 1) | Destination to store conversion results | — | — | — | — | — | — | X | — | — |

For valid device address ranges, see "Device Addresses" on page 3-1.

When the data designated by source device S1 does not comply with the normal floating-point format, a user program execution error will result, turning on special internal relay M8004 and ERR LED on the SmartAXIS. For details about the user program execution errors, see "User Program Execution Errors" on page 4-13.

Since the ATAN instruction is executed in each scan while input is on, a pulse input from a SOTU or SOTD instruction should be used.

Valid Data Types

| | |
|-----------------|---|
| W (word) | — |
| I (integer) | — |
| D (double word) | — |
| L (long) | — |
| F (float) | X |

Since floating point data is used, the source and destination devices use two consecutive data registers.

Example: ATAN

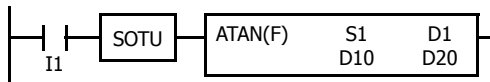

When input I1 is turned on, the arc tangent of the value of data registers D10 and D11 assigned by source device S1 is stored to data registers D20 and D21 assigned by destination device D1.

atan 0.4142136 → 0.3926992 rad

0.3926992 rad = $\pi/8$ rad

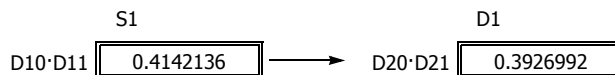

22: LOGARITHM / POWER INSTRUCTIONS

Introduction

This chapter describes logarithm and power instructions which are used to calculate logarithm or powered values of source devices.

LOGE (Natural Logarithm)

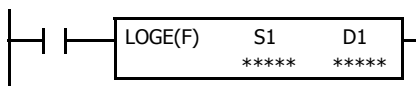

$$\log_e S1 \cdot S1+1 \rightarrow D1 \cdot D1+1$$

When input is on, the natural logarithm of the binary data assigned by source device S1 is stored to the destination assigned by device D1.

Applicable SmartAXIS

| FT1A-12 | FT1A-24 | FT1A-40 | FT1A-48 | FT1A-Touch |
|---------|---------|---------|---------|------------|
| X | X | X | X | X |

Valid Devices

| Device | Function | I | Q | M | R | T | C | D | Constant | Repeat |
|--------------------|---|---|---|---|---|---|---|---|----------|--------|
| S1 (Source 1) | Binary data to convert into natural logarithm | — | — | — | — | — | — | X | X | — |
| D1 (Destination 1) | Destination to store conversion results | — | — | — | — | — | — | X | — | — |

For valid device address ranges, see "Device Addresses" on page 3-1.

When the operation result is not within the range between -3.402823×10^{38} and $-1.175495 \times 10^{-38}$ or between 1.175495×10^{-38} and 3.402823×10^{38} , special internal relay M8003 (carry or borrow) is turned on except when the result is 0. For details, see "Carry and Borrow in Floating-Point Data Processing" on page 4-11.

When the value of S1 (source 1) is 0, a user program execution error occurs.

When the value of S1 (source 1) is less than 0, a user program execution error occurs.

When the data designated by source device S1 does not comply with the normal floating-point format, a user program execution error occurs, and the execution of the instruction is canceled. The value of D1 is left unchanged and the next instruction is executed.

When a user program execution error occurs, special internal relay M8004 and ERR LED on the SmartAXIS are turned on. For details about the user program execution errors, see "User Program Execution Errors" on page 4-13.

Since the LOGE instruction is executed in each scan while input is on, a pulse input from a SOTU or SOTD instruction should be used.

Valid Data Types

| | |
|------------------------|---|
| W (word) | — |
| I (integer) | — |
| D (double word) | — |
| L (long) | — |
| F (float) | X |

Since floating point data is used, the source and destination devices use two consecutive data registers.

Example: LOGE

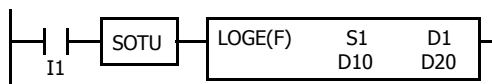

When input I1 is on, the natural logarithm of the binary data of data registers D10 and D11 assigned by source device S1 is stored to data registers D20 and D21 assigned by destination device D1.

$$\log_e 86.0 \rightarrow 4.454347$$

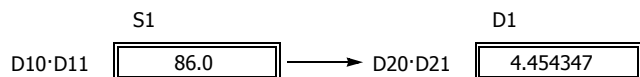

LOG10 (Common Logarithm)

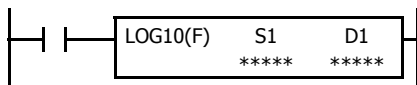

$$\log_{10} S1 \cdot S1+1 \rightarrow D1 \cdot D1+1$$

When input is on, the common logarithm of the binary data assigned by source device S1 is stored to the destination assigned by device D1.

Applicable SmartAXIS

| FT1A-12 | FT1A-24 | FT1A-40 | FT1A-48 | FT1A-Touch |
|---------|---------|---------|---------|------------|
| X | X | X | X | X |

Valid Devices

| Device | Function | I | Q | M | R | T | C | D | Constant | Repeat |
|--------------------|--|---|---|---|---|---|---|---|----------|--------|
| S1 (Source 1) | Binary data to convert into common logarithm | — | — | — | — | — | — | X | X | — |
| D1 (Destination 1) | Destination to store conversion results | — | — | — | — | — | — | X | — | — |

For valid device address ranges, see "Device Addresses" on page 3-1.

When the operation result is not within the range between -3.402823×10^{38} and $-1.175495 \times 10^{-38}$ or between 1.175495×10^{-38} and 3.402823×10^{38} , special internal relay M8003 (carry or borrow) is turned on except when the result is 0. For details, see "Carry and Borrow in Floating-Point Data Processing" on page 4-11.

When the value of S1 (source 1) is 0, a user program execution error occurs.

When the value of S1 (source 1) is less than 0, a user program execution error occurs.

When the data designated by source device S1 does not comply with the normal floating-point format, a user program execution error occurs, and the execution of the instruction is canceled. The value of D1 is left unchanged and the next instruction is executed.

When a user program execution error occurs, special internal relay M8004 and ERR LED on the SmartAXIS are turned on. For details about the user program execution errors, see "User Program Execution Errors" on page 4-13.

Since the LOG10 instruction is executed in each scan while input is on, a pulse input from a SOTU or SOTD instruction should be used.

Valid Data Types

| | |
|-----------------|---|
| W (word) | — |
| I (integer) | — |
| D (double word) | — |
| L (long) | — |
| F (float) | X |

Since floating point data is used, the source and destination devices use two consecutive data registers.

Example: LOG10

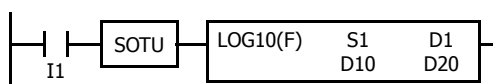

When input I1 is on, the common logarithm of the binary data of data registers D10 and D11 assigned by source device S1 is stored to data registers D20 and D21 assigned by destination device D1.

$$\log_{10} 0.0000278 \rightarrow -4.555955$$

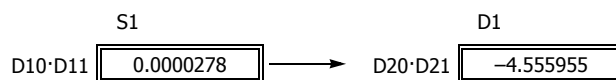

EXP (Exponent)

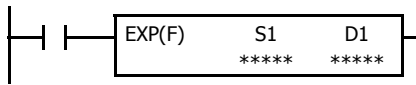

$$e^{S1 \cdot S1 + 1} \rightarrow D1 \cdot D1 + 1$$

When input is on, e is raised to the power S1·S1+1 assigned by source device S1 and is stored to the destination assigned by device D1.

e (base of natural logarithm) = 2.7182818

Applicable SmartAXIS

| FT1A-12 | FT1A-24 | FT1A-40 | FT1A-48 | FT1A-Touch |
|---------|---------|---------|---------|------------|
| X | X | X | X | X |

Valid Devices

| Device | Function | I | Q | M | R | T | C | D | Constant | Repeat |
|--------------------|------------------------------|---|---|---|---|---|---|---|----------|--------|
| S1 (Source 1) | Binary data of exponent | — | — | — | — | — | — | X | X | — |
| D1 (Destination 1) | Destination to store results | — | — | — | — | — | — | X | — | — |

For valid device address ranges, see "Device Addresses" on page 3-1.

When the operation result is not within the range between -3.402823×10^{38} and $-1.175495 \times 10^{-38}$ or between 1.175495×10^{-38} and 3.402823×10^{38} , special internal relay M8003 (carry or borrow) is turned on except when the result is 0. For details, see "Carry and Borrow in Floating-Point Data Processing" on page 4-11.

When the operation result is between $-1.175495 \times 10^{-38}$ and 1.175495×10^{-38} , the destination device designated by D1 stores 0. When the operation result is less than -3.402823×10^{38} or larger than 3.402823×10^{38} , causing an overflow, the destination device designated by D1 stores a value of minus or plus infinity.

When the data designated by source device S1 does not comply with the normal floating-point format, a user program execution error occurs, and the execution of the instruction is canceled. The value of D1 is left unchanged and the next instruction is executed.

When a user program execution error occurs, special internal relay M8004 and ERR LED on the SmartAXIS are turned on. For details about the user program execution errors, see "User Program Execution Errors" on page 4-13.

Since the EXP instruction is executed in each scan while input is on, a pulse input from a SOTU or SOTD instruction should be used.

Valid Data Types

| | |
|------------------------|---|
| W (word) | — |
| I (integer) | — |
| D (double word) | — |
| L (long) | — |
| F (float) | X |

Since floating point data is used, the source and destination devices use two consecutive data registers.

Example: EXP

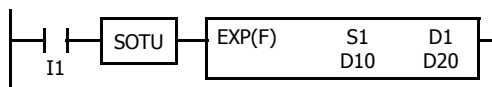

When input I1 is on, e is raised to the data of data registers D10 and D11 assigned by source device S1 and the operation result is stored to data registers D20 and D21 assigned by destination device D1.

$$e^2 = 2.7182818^2 \rightarrow 7.389056$$

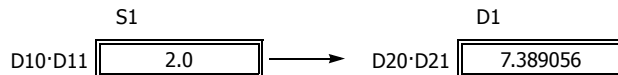

POW (Power)

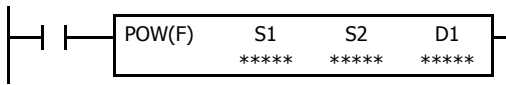

$$S1 \cdot S1+1^{S2 \cdot S2+1} \rightarrow D1 \cdot D1+1$$

When input is on, data assigned by source device S1 is raised to the power $S2 \cdot S2+1$ assigned by source device S2 and the operation result is stored to the destination assigned by device D1.

Applicable SmartAXIS

| FT1A-12 | FT1A-24 | FT1A-40 | FT1A-48 | FT1A-Touch |
|---------|---------|---------|---------|------------|
| X | X | X | X | X |

Valid Devices

| Device | Function | I | Q | M | R | T | C | D | Constant | Repeat |
|--------------------|------------------------------|---|---|---|---|---|---|---|----------|--------|
| S1 (Source 1) | Binary data of base | — | — | — | — | — | — | X | X | — |
| S2 (Source 2) | Binary data of exponent | — | — | — | — | — | — | X | X | — |
| D1 (Destination 1) | Destination to store results | — | — | — | — | — | — | X | — | — |

For valid device address ranges, see "Device Addresses" on page 3-1.

When the operation result is not within the range between -3.402823×10^{38} and $-1.175495 \times 10^{-38}$ or between 1.175495×10^{-38} to 3.402823×10^{38} , special internal relay M8003 (carry or borrow) is turned on, except when the result is 0. For details, see "Carry and Borrow in Floating-Point Data Processing" on page 4-11.

When the operation result is between $-1.175495 \times 10^{-38}$ and 1.175495×10^{-38} , the destination device designated by D1 stores 0. When the operation result is less than -3.402823×10^{38} or greater than 3.402823×10^{38} , causing an overflow, the destination device designated by D1 stores a value of minus or plus infinity.

When one of the following conditions occurs, a user program execution error occurs.

- The data designated by source device S1 is less than 0 and the data designated by source device S2 is not an integer.
- The data designated by source device S1 is 0 and the data designated by source device S2 is less than or equal to 0.

When the data designated by source device S1 or S2 does not comply with the normal floating-point format, a user program execution error occurs, and the execution of the instruction is canceled. The value of D1 is left unchanged and the next instruction is executed.

When a user program execution error occurs, special internal relay M8004 and ERR LED on the SmartAXIS are turned on. For details about the user program execution errors, see "User Program Execution Errors" on page 4-13.

Since the POW instruction is executed in each scan while input is on, a pulse input from a SOTU or SOTD instruction should be used.

Valid Data Types

| | |
|------------------------|---|
| W (word) | — |
| I (integer) | — |
| D (double word) | — |
| L (long) | — |
| F (float) | X |

Since floating point data is used, the source and destination devices use two consecutive data registers.

Example: POW

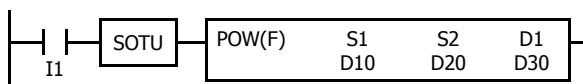

When input I1 is on, the data of data registers D10 and D11 assigned by source device S1 is raised to the power $D20 \cdot D20+1$ assigned by source device S2 and the operation result is stored to data registers D30 and D31 assigned by destination device D1.

$$4^{1.25} \rightarrow 5.656856$$

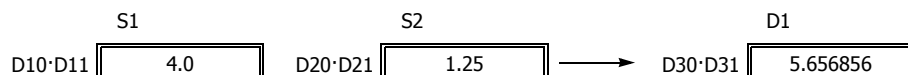

23: FILE DATA PROCESSING INSTRUCTIONS

Introduction

File data processing instructions implement the first-in first-out (FIFO) data structure. FIFOF (FIFO Format) instructions initialize the FIFO data files storing the data. FIEX (First-In Execute) instructions store new data to the FIFO data files, and FOEX (First-Out Execute) instructions retrieve the stored data from the FIFO data files. The first data to be stored to the FIFO data files by FIEX instructions will be the first data to be retrieved by FOEX instructions.

NDSRC (N Data Search) instructions search a designated value through a specified range.

FIFOF (FIFO Format)

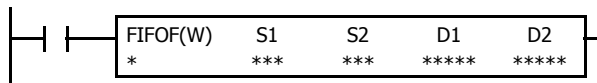

When input is on, FIFOF instruction initializes an FIFO data file. Each data file has unique number 0 through 9. A maximum of 10 data files can be used in a user program.

Applicable SmartAXIS

| FT1A-12 | FT1A-24 | FT1A-40 | FT1A-48 | FT1A-Touch |
|---------|---------|---------|---------|------------|
| X | X | X | X | X |

Valid Devices

| Device | Function | I | Q | M | R | T | C | D | Constant | Repeat |
|--------------------|---|---|---|---|---|---|---|---|----------|--------|
| N (File Number) | File Number | — | — | — | — | — | — | — | 0-9 | — |
| S1 (Source 1) | Quantity of data registers per record | — | — | — | — | — | — | — | 1-255 | — |
| S2 (Source 2) | Quantity of records | — | — | — | — | — | — | — | 2-255 | — |
| D1 (Destination 1) | First data register to store FIFO data file | — | — | — | — | — | — | X | — | — |
| D2 (Destination 2) | FIFO status output | — | — | ▲ | — | — | — | — | — | — |

For valid device address ranges, see "Device Addresses" on page 3-1.

▲ Special internal relays cannot be designated as D2.

Since the FIFOF instruction is executed in each scan while input is on, a pulse input from a SOTU or SOTD instruction should be used.

Valid Data Types

| | | |
|------------------------|---|---|
| W (word) | X | When an M (internal relay) is assigned as the D2, three internal relays starting with the device assigned by D2 are used. |
| I (integer) | — | |
| D (double word) | — | When a D (data register) is assigned as the D1, S1×S2+2 data registers starting with the device assigned by D1 are used. |
| L (long) | — | |
| F (float) | — | |

23: FILE DATA PROCESSING INSTRUCTIONS

Destination Device D1 (FIFO Data File)

FIFO data files are initialized when corresponding FIFOF instructions are executed. FIFO data file is placed in the area starting with the device designated by D1 and occupies as many as $S1 \times S2 + 2$ data registers. The size of each record is equal to S1. S1-1 records of data can be stored in an FIFO data file using FIEX instructions. The stored data can be retrieved from the FIFO data file using FOEX instructions.

| Device | Function | Description |
|------------------|-------------|---|
| D1+0 | FI pointer | The FI pointer indicates the position to store new data into the FIFO data file. When an FIEX instruction is executed, the new data in data registers starting with the device designated by S1 of the FIEX instruction is stored at the position indicated by the FI pointer, and the FI pointer is incremented by 1 to indicate the position to store the next data. When the FI pointer indicates the last record of the FIFO data file, and an FIEX instruction is executed, the FI pointer will return to 0. |
| D1+1 | FO pointer | The FO pointer indicates the position to retrieve the stored data from the FIFO data file. When an FOEX instruction is executed, the data at the position indicated by the FIFO pointer is retrieved and stored to the data registers starting with the device designated by D1 of the FOEX instruction, and the FO pointer is incremented by 1 to indicate the position to retrieve the next data. When the FO pointer indicates the last record of the FIFO data file, and an FOEX instruction is executed, the FO pointer will return to 0. |
| D1+2 | Record 0 | The first record to store the data. |
| ... | | |
| D1+(S1+1) | | |
| D1+(S1+2) | Record 1 | The second record to store the data. |
| ... | | |
| D1+(S1×2+1) | | |
| ~~~~~ | | |
| D1+(S1×(S2-1)+2) | Record S2-1 | The last record to store the data. |
| ... | | |
| D1+(S1×S2+1) | | |

Destination Device D2 (FIFO Status Output)

When FIEX or FOEX instructions are executed, the following internal relays are turned on or off according to the execution status.

| Device | Function | Description |
|--------|-----------------------------|---|
| D2+0 | Data file full output | When the value stored in the FI pointer (D1+0) is equal to the value stored in the FO pointer (D1+1) - 1, the FIFO data file is full, and no more data can be stored. If an FIEX instruction is executed when the FIFO data file is full, no operation is executed, and the data file full output (D2+0) will be turned on. |
| D2+1 | Data file empty output | When the value stored in the FI pointer (D1+0) is equal to the value stored in the FO pointer (D1+1), the FIFO data file is empty. If an FOEX instruction is executed when the FIFO data file is empty, no operation is executed, and the data file empty output (D2+1) will be turned on. |
| D2+2 | Pointer out of range output | The value stored in the FI or FO pointer can be 0 through S2-1. When an FIEX or FOEX instruction is executed while the FI or FO pointer value exceeds the valid range, no operation is executed, and the pointer out of range output (D2+2) will be turned on. |

Note: The FIFOF instruction cannot be used in an interrupt program.

If used, a user program execution error will result, turning on special internal relay M8004 and the ERR LED on the SmartAXIS. For details about the user program execution errors, see "User Program Execution Errors" on page 4-13.

FIEX (First-In Execute)

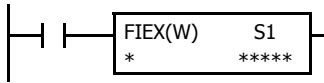

When input is on, the data stored in data registers starting with the device assigned by S1 is stored to the corresponding FIFO data file.

Applicable SmartAXIS

| FT1A-12 | FT1A-24 | FT1A-40 | FT1A-48 | FT1A-Touch |
|---------|---------|---------|---------|------------|
| X | X | X | X | X |

Valid Devices

| Device | Function | I | Q | M | R | T | C | D | Constant | Repeat |
|-----------------|---|---|---|---|---|---|---|---|----------|--------|
| N (File Number) | File number | — | — | — | — | — | — | — | 0-9 | — |
| S1 (Source 1) | First data register to store data to FIFO data file | — | — | — | — | — | — | X | — | — |

For valid device address ranges, see "Device Addresses" on page 3-1.

Make sure that FIEX instructions are executed after the corresponding FIFOF instruction has initialized the FIFO data file. If FIEX instructions are executed without executing the corresponding FIFOF instruction, a user program execution error will result, turning on special internal relay M8004 and the ERR LED on the SmartAXIS.

When a user program execution error occurs, the execution of the instruction is canceled and the next instruction is executed. For details about the user program execution errors, see "User Program Execution Errors" on page 4-13.

Since the FIEX instruction is executed in each scan while input is on, a pulse input from a SOTU or SOTD instruction should be used.

Valid Data Types

| | |
|------------------------|---|
| W (word) | X |
| I (integer) | — |
| D (double word) | — |
| L (long) | — |
| F (float) | — |

When a D (data register) is assigned as the source, as many data registers as the value stored in device S1 of the corresponding FIFOF instruction are used.

FOEX (First-Out Execute)

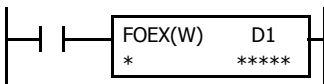

When input is on, the data is retrieved from the corresponding FIFO data file and stored to the data registers starting with the device assigned by D1.

Applicable SmartAXIS

| FT1A-12 | FT1A-24 | FT1A-40 | FT1A-48 | FT1A-Touch |
|---------|---------|---------|---------|------------|
| X | X | X | X | X |

Valid Devices

| Device | Function | I | Q | M | R | T | C | D | Constant | Repeat |
|--------------------|--|---|---|---|---|---|---|---|----------|--------|
| N (File Number) | File number | — | — | — | — | — | — | — | 0-9 | — |
| D1 (Destination 1) | First data register number to store data | — | — | — | — | — | — | X | — | — |

For valid device address ranges, see "Device Addresses" on page 3-1.

Make sure that FOEX instructions are executed after the corresponding FIFOF instruction has initialized the FIFO data file. If FOEX instructions are executed without executing the corresponding FIFOF instruction, a user program execution error will result, turning on special internal relay M8004 and the ERR LED on the SmartAXIS.

When a user program execution error occurs, the execution of the instruction is canceled and the next instruction is executed. For details about the user program execution errors, see "User Program Execution Errors" on page 4-13.

Since the FOEX instruction is executed in each scan while input is on, a pulse input from a SOTU or SOTD instruction should be used.

23: FILE DATA PROCESSING INSTRUCTIONS

Valid Data Types

| | |
|------------------------|---|
| W (word) | X |
| I (integer) | — |
| D (double word) | — |
| L (long) | — |
| F (float) | — |

When a D (data register) is assigned as the destination, as many data registers as the value stored in device S1 of the corresponding FIFOF instruction are used.

Example: FIFOF, FIEX, and FOEX

This program demonstrates a user program of the FIFOF, FIEX, and FOEX instructions to use an FIFO data file.

File number: 2
 Quantity of data registers per record: 3
 Quantity of records: 4
 FIFO Data file: D100 through D113 (3×4+2 data registers)
 FIFO status outputs: M100 through M102

Ladder Diagram

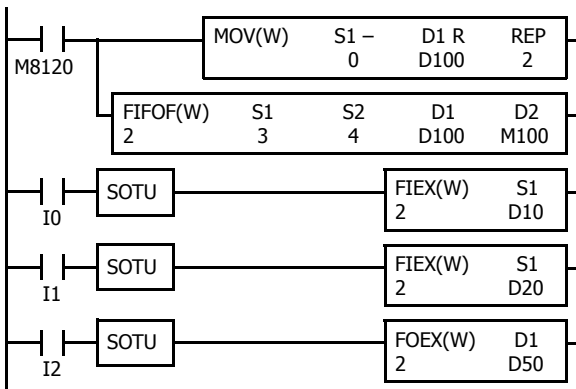

M8120 is the initialize pulse special internal relay.

When the CPU starts, MOV sets 0 to FI and FO pointers, and FIFOF initializes FIFO data file 2.

When input I0 is turned on, the data in D10 through D12 are stored to the FIFO data file 2.

When input I1 is turned on, the data in D20 through D22 are stored to the FIFO data file 2.

When input I2 is turned on, the first data is retrieved from the FIFO data file 2 and stored to D50 through D52.

FIFO Data File

The table below shows the data stored in FIFO data file 2 when inputs I0, I1, and I2 are turned on in this order. Only valid data managed by the FIFOF, FIEX, and FOEX instructions are shown in the table.

| Function | Device Address | Input I0 | Input I1 | Input I2 |
|------------|-------------------|---------------|---------------|---------------|
| FI Pointer | D100 | 1 | 2 | 2 |
| FO Pointer | D101 | 0 | 0 | 1 |
| Record 0 | D102 through D104 | D10, D11, D12 | D10, D11, D12 | — |
| Record 1 | D105 through D107 | — | D20, D21, D22 | D20, D21, D22 |
| Record 2 | D108 through D110 | — | — | — |
| Record 3 | D111 through D113 | — | — | — |

NDSRC (N Data Search)

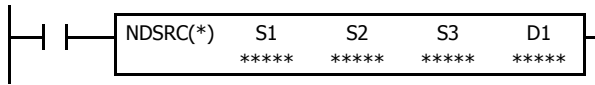

When input is on, a value specified by device S1 is searched for. Data registers are searched, starting with the data register assigned by device S2. Device S3 specifies the quantity of 1-word or 2-word blocks of data registers to search, depending on the data type.

The offset of the data register where a match first occurred is stored in data register assigned by device D1. The number of matches is stored in the next data register. When the search results in no match, 65535 is stored in device D1 and 0 is stored in device D+1.

Applicable SmartAXIS

| FT1A-12 | FT1A-24 | FT1A-40 | FT1A-48 | FT1A-Touch |
|---------|---------|---------|---------|------------|
| X | X | X | X | X |

Valid Devices

| Device | Function | I | Q | M | R | T | C | D | Constant | Repeat |
|--------------------|--------------------------------------|---|---|---|---|---|---|---|----------|--------|
| S1 (Source 1) | Value to be sought | — | — | — | — | — | — | X | X | — |
| S2 (Source 2) | First data register number to search | — | — | — | — | — | — | X | — | — |
| S3 (Source 3) | Quantity of blocks to search | — | — | — | — | — | — | X | X | — |
| D1 (Destination 1) | Search result | — | — | — | — | — | — | X | — | — |

For valid device address ranges, see "Device Addresses" on page 3-1.

Source S1 data specifies the value to be sought and the valid range depends on the data type.

The search range cannot straddle data registers and non-retentive data registers. Make sure that the sum of data register numbers designated by S1 and S2 does not result in a different data register range.

For source S3 and destination D1, 1 word is always used without regard to the data type.

Destination D1 occupies two consecutive data registers starting with the device designated by D1. Data registers D0-D998 and D1000-D1998 can be designated as destination D1.

When F (float) data is selected and S1 does not comply with the normal floating-point format, a user program execution error will result, turning on special internal relay M8004 and ERR LED on the SmartAXIS. When a user program execution error occurs, the execution of the instruction is canceled and the next instruction is executed.

When data in S2 to S2+(S3) does not comply with floating-point format, the data is skipped to continue the search and the results are stored in D1 and D1+1.

The NDSRC instruction cannot be used in an interrupt program.

If used, a user program execution error will result, turning on special internal relay M8004 and the ERR LED on the SmartAXIS.

When S3 is zero or the sum of S2 and S3 is not within the valid data register range, a user program execution error will result, turning on special internal relay M8004 and ERR LED on the SmartAXIS. When a user program execution error occurs, the execution of the instruction is canceled and the next instruction is executed.

For details about the user program execution errors, see "User Program Execution Errors" on page 4-13.

Since the NDSRC instruction is executed in each scan while input is on, a pulse input from a SOTU or SOTD instruction should be used.

Valid Data Types

| | | |
|------------------------|---|---|
| W (word) | X | When a word device such as D (data register) is assigned as the source, 1 point (word or integer data) or 2 points (double-word, long, or float data) are used. |
| I (integer) | X | |
| D (double word) | X | |
| L (long) | X | |
| F (float) | X | |

Quantity of Source and Destination Devices

Depending on the data type, source devices S1 and S2 use a different quantity of devices. Source device S3 and destination device D1 always use 1 word without regards to the data type.

| Device | W (word), I (integer) | D (double word), L (long), F (float) |
|--------|-----------------------|--------------------------------------|
| S1, S2 | 1 word device | 2 word devices |
| S3, D1 | 1 word device | 1 word device |

Examples: NDSRC

The following examples demonstrate the NDSRC instruction that searches the data of three different data types.

• **Data Type: Word**

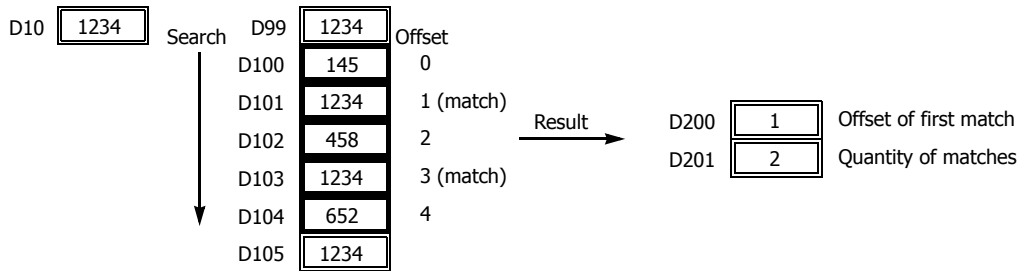
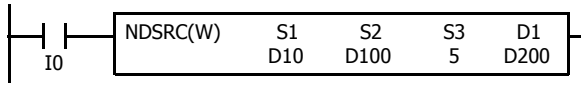

• **Data Type: Double Word**

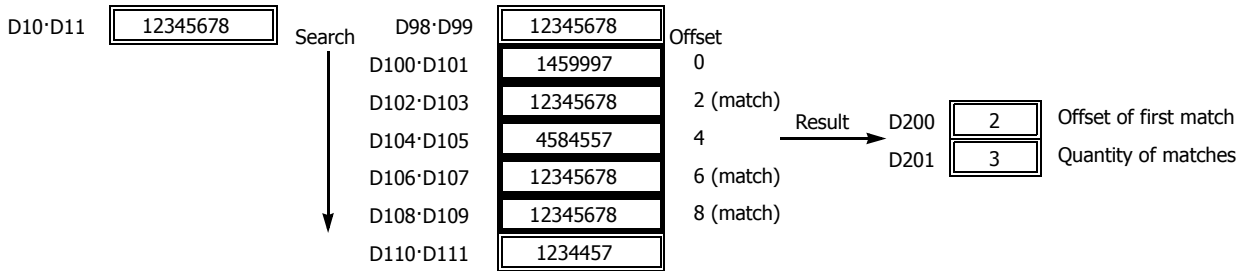
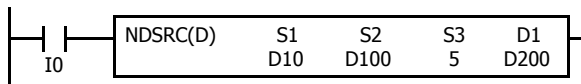

• **Data Type: Float**

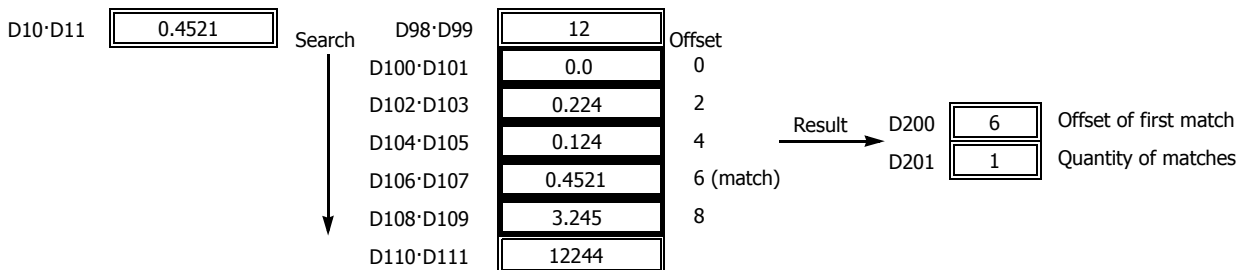
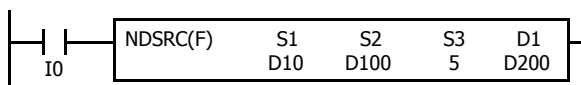

24: CLOCK INSTRUCTIONS

Introduction

TADD (time addition) and TSUB (time subtraction) instructions add or subtract time data in two different modes. The data can be selected from time (hour, minute, and second) or date/time (year, month, day, day of week, hour, minute, and second).

HTOS (HMS to sec) and STOH (sec to HMS) instructions perform conversion of time data between hours, minutes, seconds and seconds.

HOUR (hour meter) instruction measures the on duration of the input and compares the total duration to a preset value. When the preset value is reached, an output or internal relay is turned on.

TADD (Time Addition)

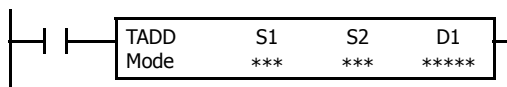

$S1 + S2 \rightarrow D1, CY$

When input is on, time data assigned by source device S2 are added to date/time data assigned by source device S1, depending on the selected mode. The result is stored to destination device D1 and carry (M8003).

Applicable SmartAXIS

| FT1A-12 | FT1A-24 | FT1A-40 | FT1A-48 | FT1A-Touch |
|---------|---------|---------|---------|------------|
| X | X | X | X | X |

Valid Devices

| Device | Function | I | Q | M | R | T | C | D | Constant | Repeat |
|--------------------|------------------------------|---|---|---|---|---|---|---|----------|--------|
| Mode | Selection of S1 data range | — | — | — | — | — | — | — | 0, 1 | — |
| S1 (Source 1) | Date/time data to add to | — | — | — | — | — | — | X | — | — |
| S2 (Source 2) | Time data to add | — | — | — | — | — | — | X | — | — |
| D1 (Destination 1) | Destination to store results | — | — | — | — | — | — | X | — | — |

For valid device address ranges, see "Device Addresses" on page 3-1.

When Mode 0 is selected, source devices S1 and S2 and destination device D1 occupy 3 consecutive data registers starting with the designated device. Data registers D0-D997 and D1000-D1997 can be designated as these devices.

When Mode 1 is selected, source device S1 and destination device D1 occupy 7 consecutive data registers starting with the designated device. Data registers D0-D993 and D1000-D1993 can be designated as these devices. Source device S2 occupies 3 consecutive data registers starting with the designated device. Data registers D0-D997 and D1000-D1997 can be designated as source device S2.

Since the TADD instruction is executed in each scan while input is on, a pulse input from a SOTU or SOTD instruction should be used.

24: CLOCK INSTRUCTIONS

Mode 0

When mode 0 is selected, time data (hour, minute, and second) stored in 3 data registers starting with source device S2 are added to the time data (hour, minute, and second) stored in 3 data registers starting with source device S1. The results are stored to 3 data registers starting with destination device D1.

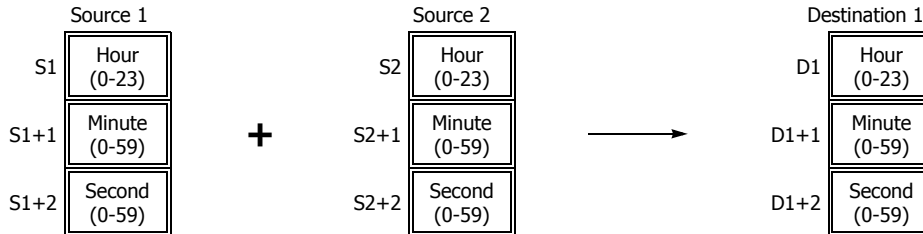

Hour data can be 0 through 23. Minute and second data can be 0 through 59.

When the execution result exceeds 23:59:59, the result is subtracted by 24 hours and stored to the data register designated by destination device D1, turning on special internal relay M8003 (carry).

When any of the hour, minute, or second data exceeds the valid range, a user program execution error will result, turning on special internal relay M8004 and the ERR LED on the SmartAXIS.

When a user program execution error occurs, the execution of the instruction is canceled and the next instruction is executed. For details about the user program execution errors, see "User Program Execution Errors" on page 4-13.

Mode 1

When mode 1 is selected, time data (hour, minute, and second) stored in 3 data registers starting with source device S2 are added to the date/time data (year, month, day, day of week, hour, minute, and second) stored in 7 data registers starting with source device S1. The results are stored to 7 data registers starting with destination device D1.

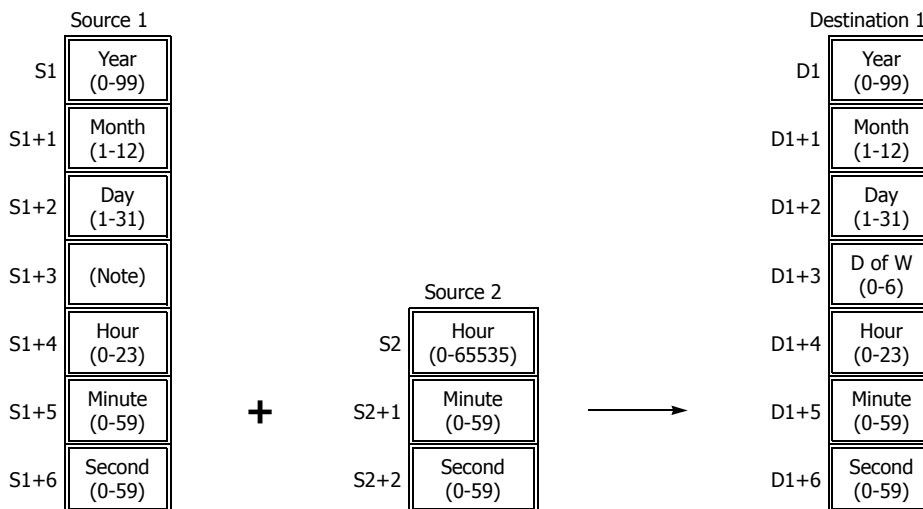

Note: Device S1+3 in source 1 is not used for execution and need not be designated.

TADD instruction supports leap years.

For source 1: Year data can be 0 through 99. Month data 1 through 12. Day data 1 through 31. Hour data 0 through 23. Minute and second data 0 through 59.

Year data 0 through 99 is processed as year 2000 through 2099.

For source 2: Hour data can be 0 through 65535. Minute and second data can be 0 through 59.

Destination 1: The day of week is calculated automatically from the resultant year, month, and day, and stored to device D1+3.

Day of week data represent: 0 (Sunday), 1 (Monday), 2 (Tuesday), 3 (Wednesday), 4 (Thursday), 5 (Friday), and 6 (Saturday).

When source 1 contains invalid day/time data, a user program execution error will result, turning on special internal relay M8004 and the ERR LED on the SmartAXIS.

When the execution result exceeds 99 year 12 month 31 day 23:59:59, a user program execution error will result, turning on special internal relay M8004 and the ERR LED on the SmartAXIS.

When a user program execution error occurs, the execution of the instruction is canceled and the next instruction is executed. For details about the user program execution errors, see "User Program Execution Errors" on page 4-13.

Examples: TADD

The following examples demonstrate the TADD instruction that will add time data in two different modes.

• **Mode 0**

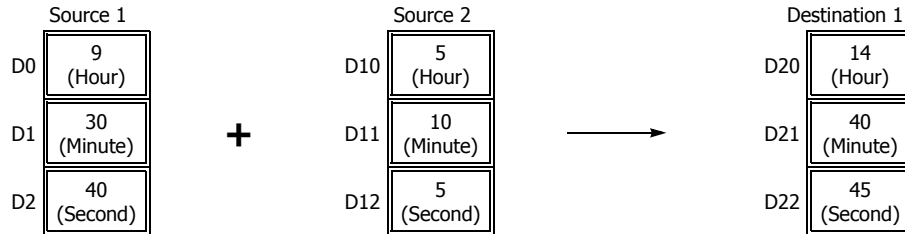
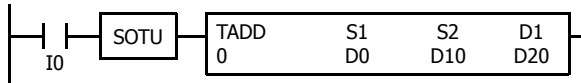

When the result exceeds 23:59:59, the resultant hour data is subtracted by 24, turning on special internal relay M8003 (carry).

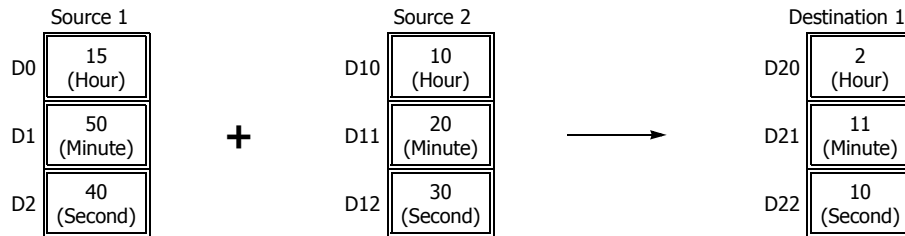

• **Mode 1**

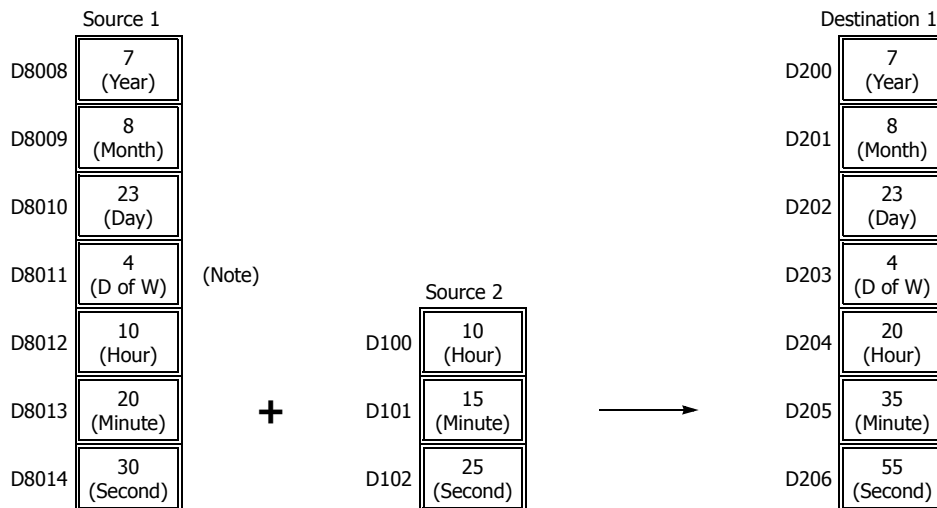
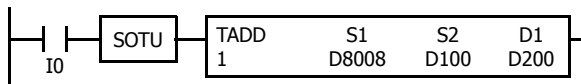

Note: D8011 in source 1 is not used for execution and does not need to be designated. The day of week is calculated automatically from the resultant year, month, and day, and stored to D203 of destination 1.

24: CLOCK INSTRUCTIONS

When the result exceeds 23:59:59, the resultant hour data is subtracted by a multiple of 24 and the day data is incremented.

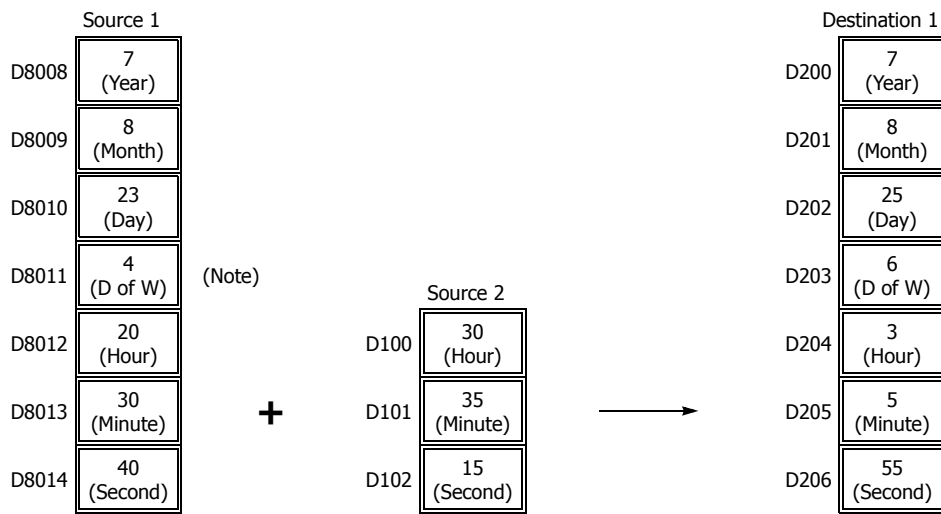

Note: D8011 in source 1 is not used for execution and does not need to be designated. The day of week is calculated automatically from the resultant year, month, and day, and stored to D203 of destination 1.

TSUB (Time Subtraction)

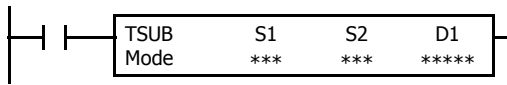

$$S1 - S2 \rightarrow D1, CY$$

When input is on, time data assigned by source device S2 is subtracted from date/time data assigned by source device S1, depending on the selected mode. The result is stored to destination device D1 and borrow (M8003).

Applicable SmartAXIS

| FT1A-12 | FT1A-24 | FT1A-40 | FT1A-48 | FT1A-Touch |
|---------|---------|---------|---------|------------|
| X | X | X | X | X |

Valid Devices

| Device | Function | I | Q | M | R | T | C | D | Constant | Repeat |
|--------------------|---------------------------------|---|---|---|---|---|---|---|----------|--------|
| Mode | Selection of S1 data range | — | — | — | — | — | — | — | 0, 1 | — |
| S1 (Source 1) | Date/time data to subtract from | — | — | — | — | — | — | X | — | — |
| S2 (Source 2) | Time data to subtract | — | — | — | — | — | — | X | — | — |
| D1 (Destination 1) | Destination to store results | — | — | — | — | — | — | X | — | — |

For valid device address ranges, see "Device Addresses" on page 3-1.

When Mode 0 is selected, source devices S1 and S2 and destination device D1 occupy 3 consecutive data registers starting with the designated device. Data registers D0-D997 and D1000-D1997 can be designated as these devices.

When Mode 1 is selected, source device S1 and destination device D1 occupy 7 consecutive data registers starting with the designated device. Data registers D0-D993 and D1000-D1993 can be designated as these devices. Source device S2 occupies 3 consecutive data registers starting with the designated device. Data registers D0-D997 and D1000-D1997 can be designated as source device S2.

Since the TSUB instruction is executed in each scan while input is on, a pulse input from a SOTU or SOTD instruction should be used.

24: CLOCK INSTRUCTIONS

Mode 0

When mode 0 is selected, time data (hour, minute, and second) stored in 3 data registers starting with source device S2 is subtracted from the time data (hour, minute, and second) stored in 3 data registers starting with source device S1. The results are stored to 3 data registers starting with destination device D1.

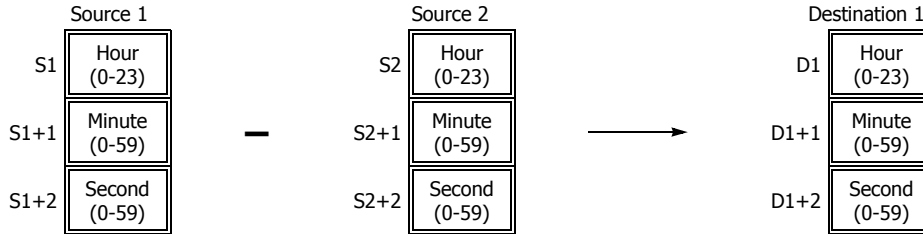

Hour data can be 0 through 23. Minute and second data can be 0 through 59.

When the execution result is less than 00:00:00, 24 hour is added to the result and stored to the data register designated by destination device D1, turning on special internal relay M8003 (borrow).

When any of the hour, minute, or second data exceeds the valid range, a user program execution error will result, turning on special internal relay M8004 and the ERR LED on the SmartAXIS.

When a user program execution error occurs, the execution of the instruction is canceled and the next instruction is executed. For details about the user program execution errors, see "User Program Execution Errors" on page 4-13.

Mode 1

When mode 1 is selected, time data (hour, minute, and second) stored in 3 data registers starting with source device S2 is subtracted from the date/time data (year, month, day, day of week, hour, minute, and second) stored in 7 data registers starting with source device S1. The results are stored to 7 data registers starting with destination device D1.

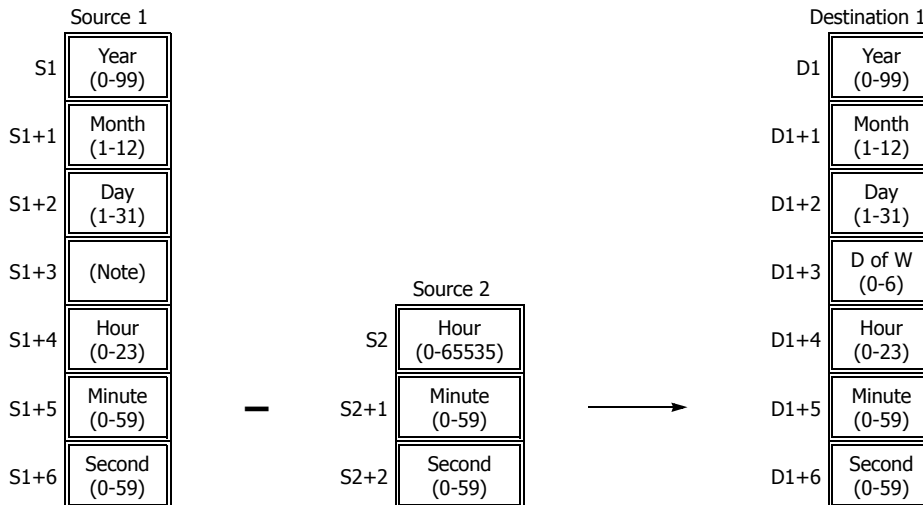

Note: Device S1+3 in source 1 is not used for execution and need not be designated.

TSUB instruction supports leap years.

For source 1: Year data can be 0 through 99. Month data 1 through 12. Day data 1 through 31. Hour data 0 through 23. Minute and second data 0 through 59.

Year data 0 through 99 is processed as year 2000 through 2099.

For source 2: Hour data can be 0 through 65535. Minute and second data can be 0 through 59.

Destination 1: The day of week is calculated automatically from the resultant year, month, and day, and stored to device D1+3.

Day of week data represent: 0 (Sunday), 1 (Monday), 2 (Tuesday), 3 (Wednesday), 4 (Thursday), 5 (Friday), and 6 (Saturday).

When source 1 contains invalid day/time data, a user program execution error will result, turning on special internal relay M8004 and the ERR LED on the SmartAXIS.

When the execution result is less than 00 year 1 month 1 day 00:00:00, a user program execution error will result, turning on special internal relay M8004 and the ERR LED on the SmartAXIS.

When a user program execution error occurs, the execution of the instruction is canceled and the next instruction is executed. For details about the user program execution errors, see "User Program Execution Errors" on page 4-13.

Examples: TSUB

The following examples demonstrate the TSUB instruction to that will subtract time data in two different modes.

• **Mode 0**

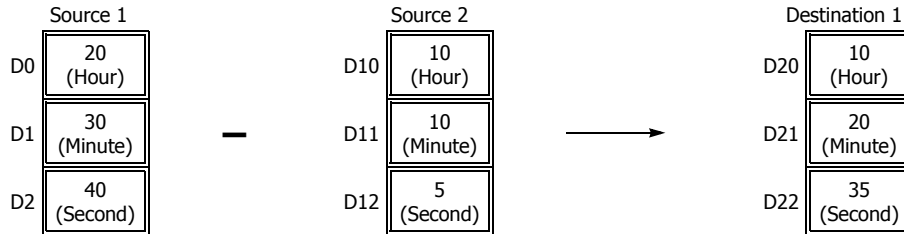
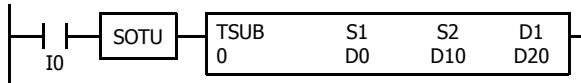

When the result is less than 00:00:00, 24 is added to the result, turning on special internal relay M8003 (borrow).

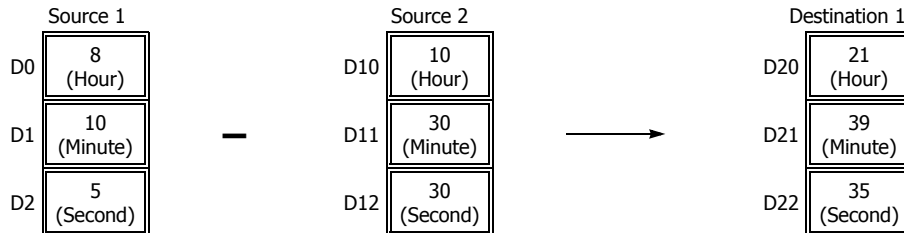

• **Mode 1**

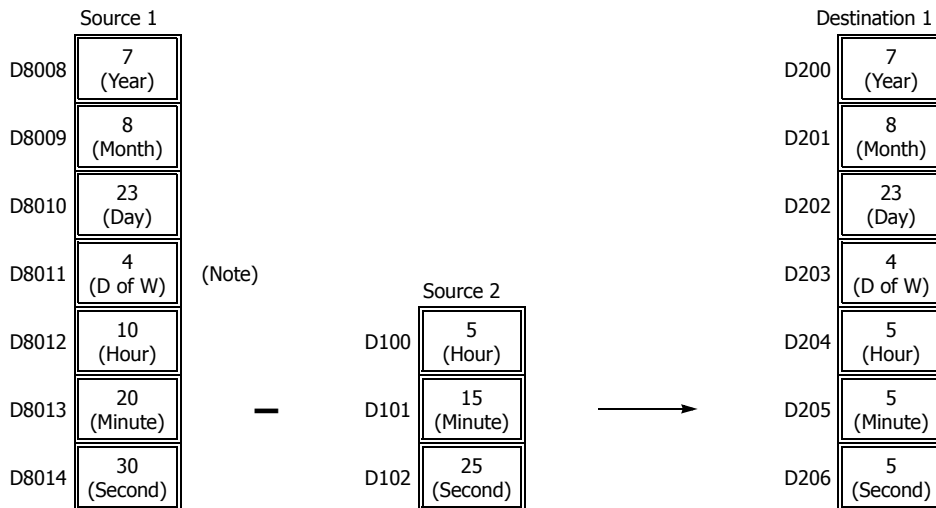
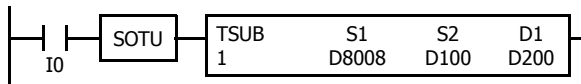

Note: D8011 in source 1 is not used for execution and does not need to be designated. The day of week is calculated automatically from the resultant year, month, and day, and stored to D203 of destination 1.

24: CLOCK INSTRUCTIONS

When the result is less than 00:00:00, 24 is added to the result, and the day data is decremented.

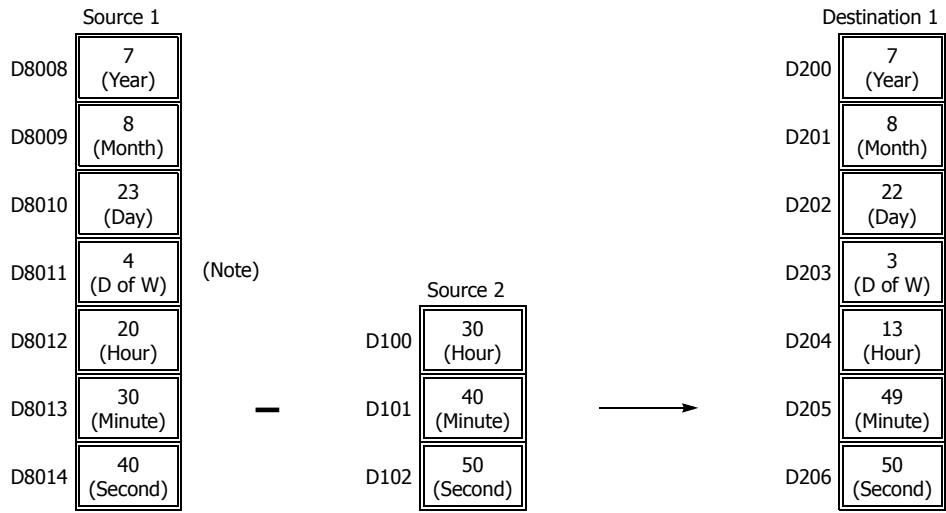

Note: D8011 in source 1 is not used for execution and does not need to be designated. The day of week is calculated automatically from the resultant year, month, and day, and stored to D203 of destination 1.

HTOS (HMS to Sec)



Hours, minutes, seconds → Seconds

When input is on, time data in hours, minutes, and seconds assigned by source device S1 is converted into seconds. The result is stored to destination device D1.

Applicable SmartAXIS

| FT1A-12 | FT1A-24 | FT1A-40 | FT1A-48 | FT1A-Touch |
|---------|---------|---------|---------|------------|
| X | X | X | X | X |

Valid Devices

| Device | Function | I | Q | M | R | T | C | D | Constant | Repeat |
|--------------------|--------------------------------------|---|---|---|---|---|---|---|----------|--------|
| S1 (Source 1) | Time data in hours, minutes, seconds | — | — | — | — | — | — | X | — | — |
| D1 (Destination 1) | Destination to store results | — | — | — | — | — | — | X | — | — |

For valid device address ranges, see "Device Addresses" on page 3-1.

Source device S1 occupies 3 consecutive data registers starting with the designated device. Data registers D0-D997 and D1000-D1997 can be designated as source device S1.

Destination device D1 occupies 2 consecutive data registers to store double-word data, starting with the designated device. Data registers D0-D998 and D1000-D1998 can be designated as destination device D1.

Hour data can be 0 through 65535. Minute and second data can be 0 through 59.

When any of the hour, minute, or second data exceeds the valid range, a user program execution error will result, turning on special internal relay M8004 and the ERR LED on the SmartAXIS. When a user program execution error occurs, the execution of the instruction is canceled and the next instruction is executed.

When the execution of the instruction is canceled, the data in D1 and D1+1 is left unchanged. For details about the user program execution errors, see "User Program Execution Errors" on page 4-13.

Since the HTOS instruction is executed in each scan while input is on, a pulse input from a SOTU or SOTD instruction should be used.

Examples: HTOS

The following examples demonstrate the HTOS instruction that will convert time data in hours, minutes, and seconds into seconds and store the results to two consecutive data registers.

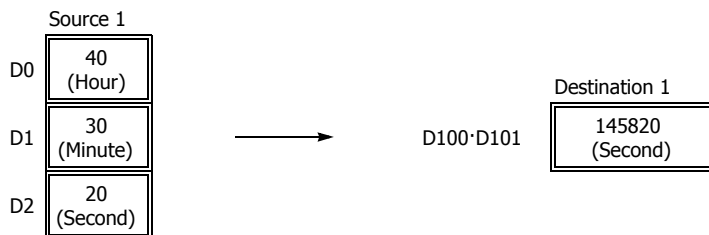
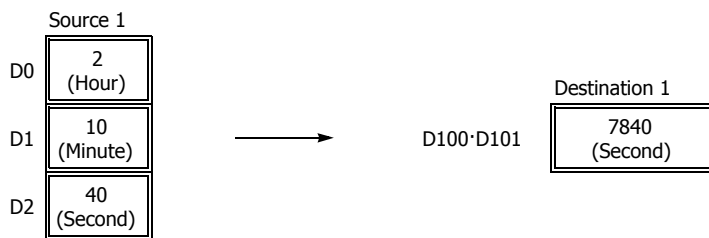

24: CLOCK INSTRUCTIONS

STOH (Sec to HMS)

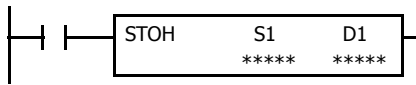

Seconds → Hours, minutes, seconds

When input is on, time data in seconds assigned by source device S1 is converted into hours, minutes, and seconds. The result is stored to destination device D1.

Applicable SmartAXIS

| FT1A-12 | FT1A-24 | FT1A-40 | FT1A-48 | FT1A-Touch |
|---------|---------|---------|---------|------------|
| X | X | X | X | X |

Valid Devices

| Device | Function | I | Q | M | R | T | C | D | Constant | Repeat |
|--------------------|------------------------------|---|---|---|---|---|---|---|----------|--------|
| S1 (Source 1) | Time data in seconds | — | — | — | — | — | — | X | X | — |
| D1 (Destination 1) | Destination to store results | — | — | — | — | — | — | X | — | — |

For valid device address ranges, see "Device Addresses" on page 3-1.

Source device S1 occupies 2 consecutive data registers to store double-word data, starting with the designated device. Data registers D0-D998 and D1000-D1998 can be designated as source device S1.

Destination device D1 occupies 3 consecutive data registers starting with the designated device. Data registers D0-D997 and D1000-D1997 can be designated as destination device D1.

Second data for source device S1 can be 0 through 4,294,967,295.

When the conversion result exceeds 65535 hours 59 minutes 59 seconds, special internal relay M8003 (carry) is turned on. For example, when the conversion result is 65537 hours 0 minute 0 second, destination 1 stores 1 hour 0 minute 0 second, turning on special internal relay M8003 (carry).

Since the STOH instruction is executed in each scan while input is on, a pulse input from a SOTU or SOTD instruction should be used.

Examples: STOH

The following examples demonstrate the STOH instruction that will convert time data in seconds into hours, minutes, and seconds and store the results to three consecutive data registers.

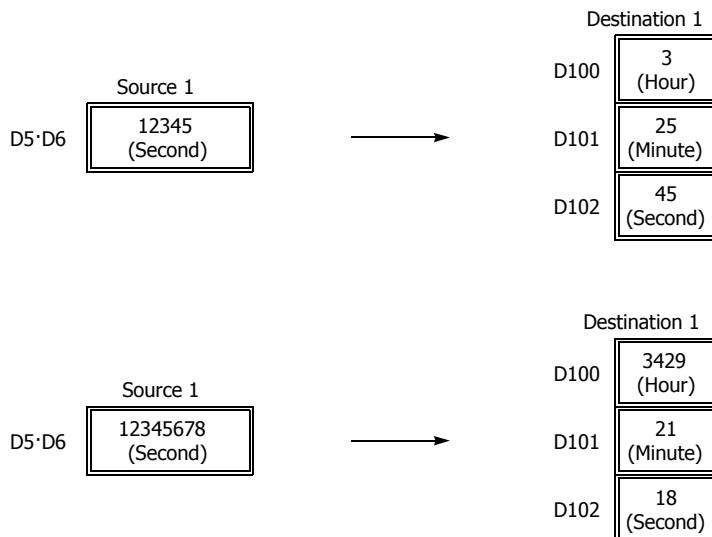
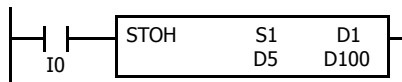

HOUR (Hour Meter)

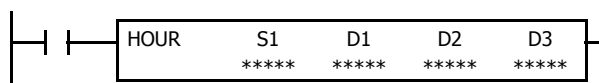

S1 ↔ D1 → D2

While input is on, the ON duration of the input is measured. The measured time value (hour, minute, and second) is stored to 3 consecutive data registers assigned by destination device D1 and compared with the preset value assigned by source device S1.

When the D1 value reaches the S1 value, an output or internal relay assigned by destination device D2 is turned on.

Two data registers starting with destination device D3 are reserved for system work area.

Applicable SmartAXIS

| FT1A-12 | FT1A-24 | FT1A-40 | FT1A-48 | FT1A-Touch |
|---------|---------|---------|---------|------------|
| X | X | X | X | X |

Valid Devices

| Device | Function | I | Q | M | R | T | C | D | Constant | Repeat |
|--------------------|----------------------------|---|---|---|---|---|---|---|----------|--------|
| S1 (Source 1) | Preset value | — | — | — | — | — | — | X | 0-65535 | — |
| D1 (Destination 1) | Measured input ON duration | — | — | — | — | — | — | X | — | — |
| D2 (Destination 2) | Comparison output | — | X | ▲ | — | — | — | — | — | — |
| D3 (Destination 3) | System work area | — | — | — | — | — | — | X | — | — |

For valid device address ranges, see "Device Addresses" on page 3-1.

Source device S1 can be designated by a data register or constant.

Source device S1, when designated by a data register, and destination device D1 occupy 3 consecutive data registers starting with the designated device to store hour, minute, and second data. Data registers D0-D997 and D1000-D1997 can be designated as these devices.

When source device S1 is designated by a constant, the preset value can be 0 through 65535 in hours, then minutes and seconds are set to 0.

▲ Special internal relays cannot be designated as destination device D2.

Destination device D3 requires two data registers reserved for system work area.

Hour data can be 0 through 65535. Minute and second data can be 0 through 59.

When the measured input ON duration value in destination device D1 reaches the preset value designated by source device S1, the comparison output designated by destination device D2 turns on. As long as the input remains on, the measured input ON duration value continues to increase. When the measured input ON duration value exceeds 65535 hours 59 minutes 59 seconds, the value returns to 0 hours 0 minutes 0 seconds to repeat another measuring cycle, with the comparison output remaining on.

When any of the hour, minute, or second data of source device S1 exceeds the valid range, a user program execution error will result, turning on special internal relay M8004 and the ERR LED on the SmartAXIS, but the input ON duration is measured.

When any of the hour, minute, or second data of source device S1 is changed to an invalid value after the comparison output has turned on, the comparison output is turned off. Then a user program execution error will result, turning on special internal relay M8004 and the ERR LED on the SmartAXIS, but the input ON duration measurement is continued. For user program execution errors, see "User Program Execution Errors" on page 4-13.

24: CLOCK INSTRUCTIONS

Examples: HOUR

The following examples demonstrate the HOUR instruction that will measure the input ON duration value in hours, minutes, and seconds and to compare the value in two different ways.

- **Source Device S1: Data Register**

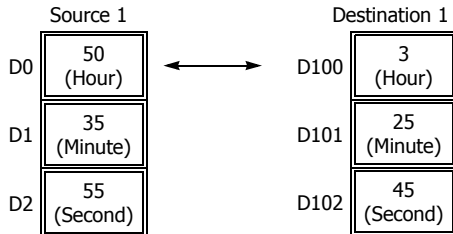
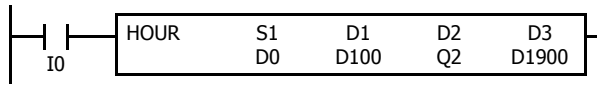

$D0 \cdot D1 \cdot D2 \ll D100 \cdot D101 \cdot D102 \rightarrow Q2$

While input I0 is on, the ON duration is measured. The measured time value (hour, minute, and second) is stored to data registers D100·D101·D102 assigned by destination device D1 and compared with the preset value stored in data registers D0·D1·D2 assigned by source device S1.

When the measured value reaches the preset value, output Q2 assigned by destination device D2 is turned on.

Data registers D1900 and D1901 assigned by destination device D3 are reserved for system work area.

- **Source Device S1: Constant**

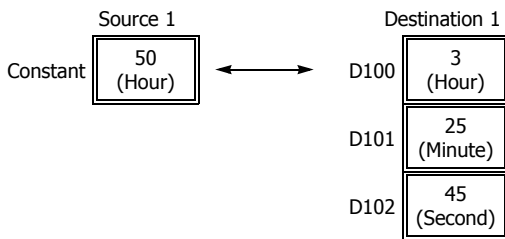
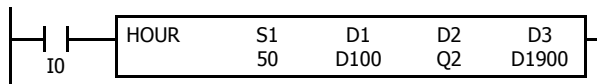

$50 \ll D100 \cdot D101 \cdot D102 \rightarrow Q2$

While input I0 is on, the ON duration is measured. The measured time value (hour, minute, and second) is stored to data registers D100·D101·D102 assigned by destination device D1 and compared with 50 hours assigned by source device S1.

When the measured value reaches 50 hours, output Q2 assigned by destination device D2 is turned on.

Data registers D1900 and D1901 assigned by destination device D3 are reserved for system work area.

25: USER COMMUNICATION INSTRUCTIONS

Introduction

User communication instructions convert data to the specified data type and transmit and receive that data.

The user communication instructions can be used on expansion communication ports or the Ethernet port. To perform user communication with external devices connected on the expansion communication ports, use the TXD (user communication transmit) and RXD (user communication receive) instructions. To perform user communication with external devices connected over the Ethernet, use the ETXD (User communication transmit over Ethernet) and ERXD (User communication receive over Ethernet) instructions.

TXD (Transmit)

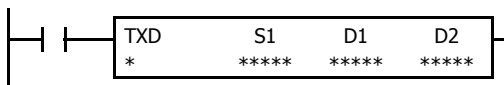

When input is on, data assigned by S1 is converted into a specified format and transmitted from port 2 through port 3 to a remote terminal with an RS232C/RS485 port.

Applicable SmartAXIS

| FT1A-12 | FT1A-24 | FT1A-40 | FT1A-48 | FT1A-Touch |
|---------|---------|-----------|-----------|------------|
| — | TXD2 | TXD2-TXD3 | TXD2-TXD3 | — |

Valid Devices

| Device | Function | I | Q | M | R | T | C | D | Constant | Repeat |
|--------------------|----------------------------|---|---|---|---|---|---|---|----------|--------|
| S1 (Source 1) | Transmit data | — | — | — | — | — | — | X | X | — |
| D1 (Destination 1) | Transmit completion output | — | X | ▲ | — | — | — | — | — | — |
| D2 (Destination 2) | Transmit status register | — | — | — | — | — | — | X | — | — |

For valid device address ranges, see "Device Addresses" on page 3-1.

▲ Internal relays M0 through M1277 can be designated as D1. Special internal relays cannot be designated as D1.

Transmit data designated by device S1 can be a maximum of 200 bytes.

When transmission is complete, an output or internal relay, designated by device D1, is turned on.

Destination 2 occupies two consecutive data registers starting with the device designated by D2. The transmit status data register, D0-D1998, stores the status of transmission and error code. The next data register stores the byte count of transmitted data. The same data registers cannot be used as transmit status registers for TXD2 through TXD3 instructions and receive status registers for RXD2 through RXD3 instructions.

The TXD instructions cannot be used in an interrupt program. If used, a user program execution error will result, turning on special internal relay M8004 and the ERR LED on the SmartAXIS. For details about the user program execution errors, see "User Program Execution Errors" on page 4-13.

Precautions for Programming TXD Instruction

- The SmartAXIS has five formatting areas each for executing TXD2 through TXD3 instructions, so five instructions each of TXD2 through TXD3 can be processed at the same time. If inputs to more than five of the same TXD instructions are turned on at the same time, an error code is set to the transmit status data register, designated by device D2, in the excessive TXD instructions that cannot be executed.
- If the input for a TXD instruction turns on while another TXD instruction is executed, the subsequent TXD instruction is executed 2 scan times after the preceding TXD instruction is completed.
- Since TXD instructions are executed in each scan while input is on, a pulse input from a SOTU or SOTD instruction should be used.

User Communication Transmit Instruction Dialog Box in WindLDR

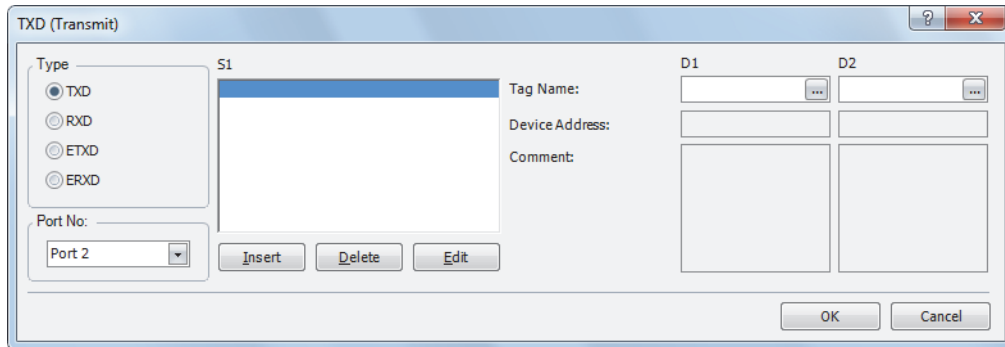

Selections and Devices in Transmit Instruction Dialog Box

| | | |
|-------------|------------------------|--|
| Type | TXD | Transmit instruction |
| | RXD | Receive instruction |
| Port | Port 2 - Port 3 | Transmit user communication from port 2 (TXD2) through port 3 (TXD3) |
| S1 | Source 1 | Enter the data to transmit in this area. Transmit data can be constant values (character or hexadecimal), data registers, or BCC. |
| D1 | Destination 1 | Transmit completion output can be an output or internal relay. |
| D2 | Destination 2 | Transmit status register can be data register D0-D1998. The next data register stores the byte count of transmitted data. |

Transmit Data

Transmit data is designated by source device S1 using constant values or data registers. BCC code can also be calculated automatically and appended to the transmit data. One TXD instruction can transmit a maximum of 200 bytes of data.

S1 (Source 1)

| Transmit Data | Device | Conversion Type | Transmit Digits (Bytes) | Repeat | BCC Calculation | Calculation Start Position |
|----------------------|---------------|--|-------------------------|--------|--|----------------------------|
| Constant | 00h-7Fh (FFh) | No conversion | 1 | — | — | — |
| Data Register | D0-D1999 | A: Binary to ASCII | 1-4 | 1-99 | — | — |
| | | B: BCD to ASCII | 1-5 | | | |
| | | —: No conversion | 1-2 | | | |
| BCC | — | A: Binary to ASCII —: No conversion | 1-2 | — | X: XOR A: ADD C: Add-2comp M: Modbus ASCII M: Modbus RTU | 1-15 |

Note: Total byte count of the transmit data is shown in S1 of TXD instruction on the ladder diagram of WindLDR.

Designating Constant as S1

When a constant value is designated as source device S1, one-byte data is transmitted without conversion. The valid transmit data value depends on the data bits selected in the Communication Parameters dialog box. These data bits are set in **Configuration > Comm. Ports**, followed by selecting **User Protocol** in Port 2 through Port 3 list box and clicking the **Configure** button. When 7 data bits are selected as default, 00h through 7Fh is transmitted. When 8 data bits are selected, 00h through FFh is transmitted. Constant values are entered in character or hexadecimal notation into the source data.

Constant (Character)

Any character available on the computer keyboard can be entered. One character is counted as one byte.

Constant (Hexadecimal)

Use this option to enter the hexadecimal code of any ASCII character. ASCII control codes NUL (00h) through US (1Fh) can also be entered using this option.

Example:

The following example shows two methods to enter 3-byte ASCII data "1" (31h), "2" (32h), "3" (33h).

(1) Constant (Character)

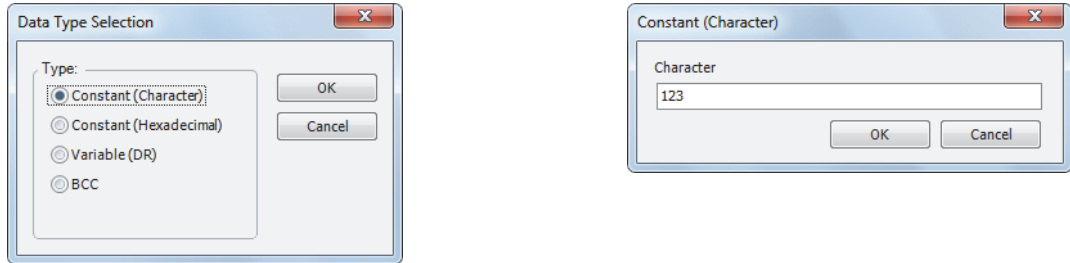

(2) Constant (Hexadecimal)

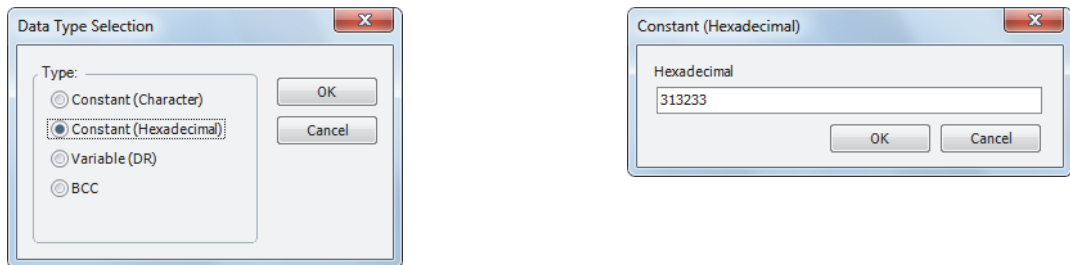

Designating Data Register as S1

When a data register is designated as source device S1, conversion type and transmit digits must also be assigned. The data stored in the designated data register is converted and the assigned quantity of digits of the resultant data is transmitted. The conversion types that are available are: Binary to ASCII, BCD to ASCII, and no conversion.

When repeat is designated, data of data registers as many as the repeat cycles are transmitted, starting with the designated data register. Repeat cycles can be up to 99.

Conversion Type

The transmit data is converted according to the designated conversion type as described below:

Example: D10 stores 000Ch (12)

(1) Binary to ASCII conversion

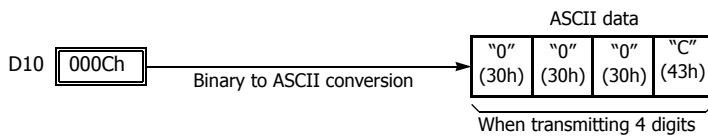

(2) BCD to ASCII conversion

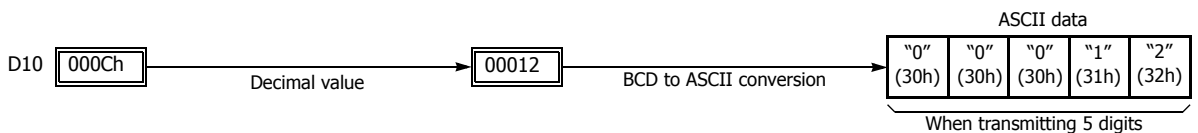

(3) No conversion

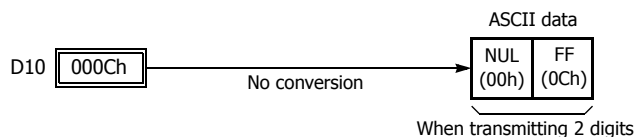

25: USER COMMUNICATION INSTRUCTIONS

Transmit Digits (Bytes)

After conversion, the transmit data is taken out in specified digits. Possible digits depend on the selected conversion type.

Example: D10 stores 010Ch (268)

(1) Binary to ASCII conversion, Transmit digits = 2

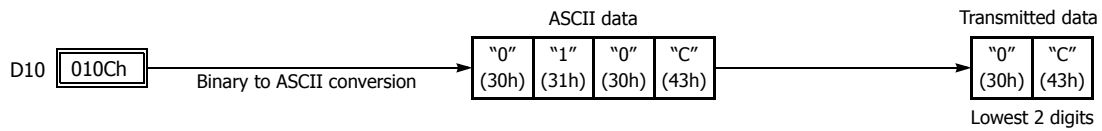

(2) BCD to ASCII conversion, Transmit digits = 3

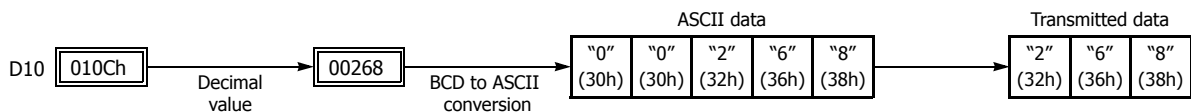

(3) No conversion, Transmit digits = 1

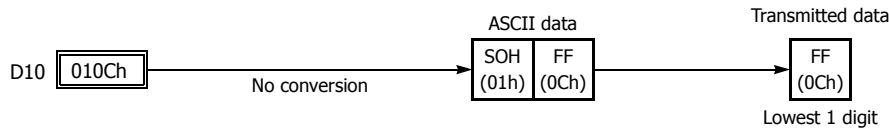

Repeat Cycles

When a data register is assigned to repeat, as many consecutive data registers, as the repeat cycles, are used to transmit data in the same conversion type and transmit digits.

Example:

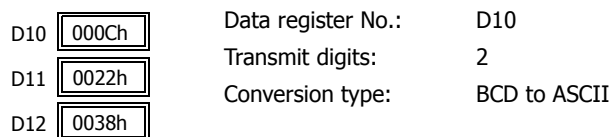

Data from data registers starting with D10 is converted in BCD to ASCII and is transmitted according to the designated repeat cycles.

(1) Repeat cycles = 2

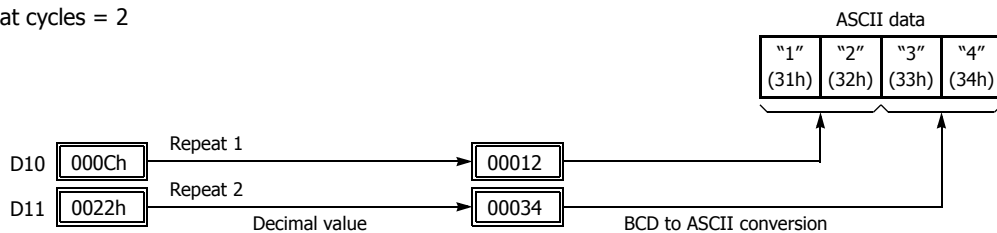

(2) Repeat cycles = 3

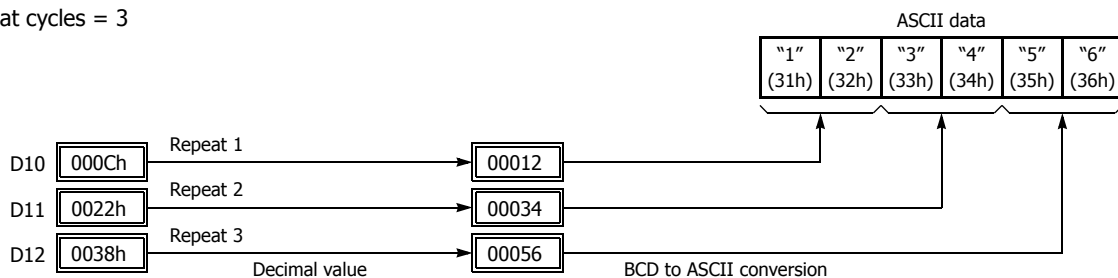

BCC (Block Check Character)

Block check characters can be appended to the transmit data. The start position for the BCC calculation can be selected from the first byte through the 15th byte. The BCC can be 1 or 2 digits.

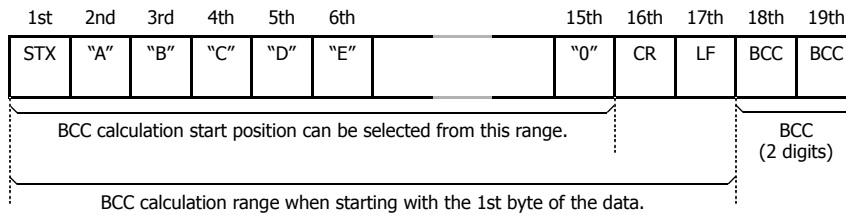

BCC Calculation Start Position

The start position for the BCC calculation can be specified from the first byte through the 15th byte. The BCC is calculated for the range starting at the designated position up to the byte immediately before the BCC of the transmit data.

Example: Transmit data consists of 17 bytes plus 2 BCC digits.

(1) Calculation start position = 1

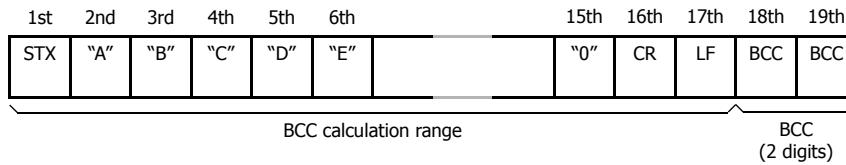

(2) Calculation start position = 2

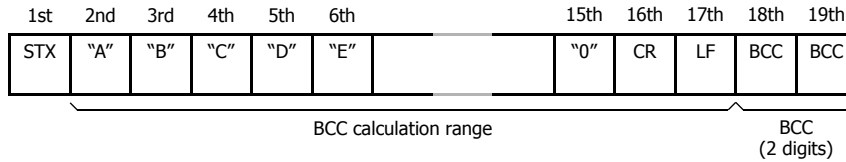

BCC Calculation Formula

BCC calculation formula can be selected from XOR (exclusive OR), ADD (addition), ADD-2comp, Modbus ASCII, or Modbus RTU.

Example: Conversion results of transmit data consist of 41h, 42h, 43h, and 44h.

| ASCII data | | | |
|------------|-------|-------|-------|
| "A" | "B" | "C" | "D" |
| (41h) | (42h) | (43h) | (44h) |

(1) BCC calculation formula = XOR

Calculation result = $41h \oplus 42h \oplus 43h \oplus 44h = 04h$

(2) BCC calculation formula = ADD

Calculation result = $41h + 42h + 43h + 44h = 10Ah \rightarrow 0Ah$ (Only the last 1 or 2 digits are used as BCC.)

(3) BCC calculation formula = ADD-2comp

Calculation result = FEh, F6h (2 digits without conversion)

(4) BCC calculation formula = Modbus ASCII

Calculation result = 88 (ASCII)

(5) BCC calculation formula = Modbus RTU

Calculation result = 85h 0Fh (binary)

25: USER COMMUNICATION INSTRUCTIONS

Conversion Type

The BCC calculation result is converted or not according to the designated conversion type as described below:

Example: BCC calculation result is 0041h.

(1) Binary to ASCII conversion

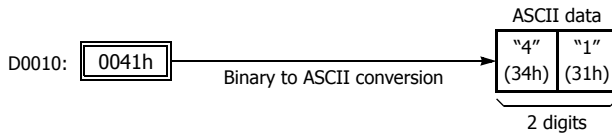

Note: On WindLDR, Modbus ASCII is defaulted to binary to ASCII conversion.

(2) No conversion

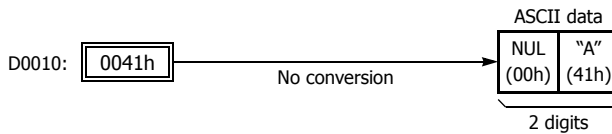

Note: On WindLDR, Modbus RTU is defaulted to no conversion.

BCC Digits (Bytes)

The quantity of digits (bytes) of the BCC code can be selected from 1 or 2.

Example:

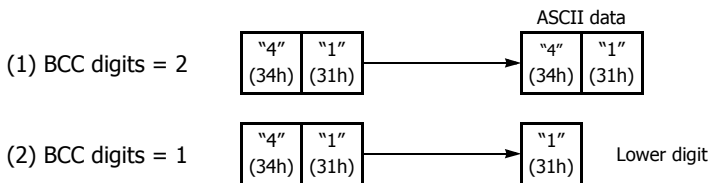

Note: On WindLDR, Modbus ASCII and Modbus RTU are defaulted to 2 digits.

Transmit Completion Output

Designate an output, Q0 through Q21, or an internal relay, M0 through M1277, as a device for the transmit completion output. Special internal relays cannot be used.

When the start input for a TXD instruction is turned on, preparation for transmission is initiated, followed by data transmission. When a sequence of all transmission operations is complete, the designated output or internal relay is turned on.

Transmit Status

Designate a data register, D0-D1998, as a device to store the transmit status information including a transmission status code and a user communication error code.

Transmit Status Code

| Transmit Status Code | Status | Description |
|----------------------|-------------------------------|--|
| 16 | Preparing transmission | From turning on the start input for a TXD instruction, until the transmit data is stored in the internal transmit buffer |
| 32 | Transmitting data | From enabling data transmission by an END processing, until all data transmission is completed |
| 48 | Data transmission complete | From completing all data transmission, until the END processing is completed for the TXD instruction |
| 64 | Transmit instruction complete | All transmission operation is completed and the next transmission is made possible |

If the transmit status code is other than shown above, a transmit instruction error is suspected. See Chapter 10 "User Communication Instructions" - "User Communication Error" in the SmartAXIS Pro/Lite User's Manual.

Transmit Data Byte Count

The data register next to the device designated for transmit status stores the byte count of data transmitted by the TXD instruction. When BCC is included in the transmit data, the byte count of the BCC is also included in the transmit data byte count.

Example: Data register D100 is designated as a device for transmit status.

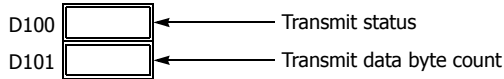

RXD (Receive)

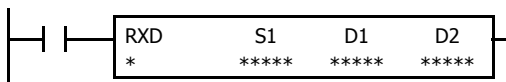

When input is on, data from an RS232C/RS485 remote terminal received by port 2 through port 3 is converted and stored in data registers according to the receive format assigned by S1.

Applicable SmartAXIS

| FT1A-12 | FT1A-24 | FT1A-40 | FT1A-48 | FT1A-Touch |
|---------|---------|-----------|-----------|------------|
| — | RXD2 | RXD2-RXD3 | RXD2-RXD3 | — |

Valid Devices

| Device | Function | I | Q | M | R | T | C | D | Constant | Repeat |
|--------------------|---------------------------|---|---|---|---|---|---|---|----------|--------|
| S1 (Source 1) | Receive format | — | — | — | — | — | — | X | X | — |
| D1 (Destination 1) | Receive completion output | — | X | ▲ | — | — | — | — | — | — |
| D2 (Destination 2) | Receive status | — | — | — | — | — | — | X | — | — |

For valid device address ranges, see "Device Addresses" on page 3-1.

▲ Internal relays M0 through M1277 can be designated as D1. Special internal relays cannot be designated as D1.

Receive format designated by device S1 can be a maximum of 200 bytes.

When data receive is complete, an output or internal relay, designated by device D1, is turned on.

Destination 2 occupies two consecutive data registers starting with the device designated by D2. The receive status data register, D0-D1998, stores the status of data receive and error code. The next data register stores the byte count of received data. The same data registers can not be used as transmit status registers for TXD2 through TXD3 instructions and receive status registers for RXD2 through RXD3 instructions.

The RXD instructions cannot be used in an interrupt program. If used, a user program execution error will result, turning on special internal relay M8004 and the ERR LED on the SmartAXIS. For details about the user program execution errors, see "User Program Execution Errors" on page 4-13.

Precautions for Programming the RXD Instruction

- The SmartAXIS can execute a maximum of five instructions each of RXD2 through RXD3 that have a start delimiter at the same time. If a start delimiter is not programmed in RXD2 through RXD3 instructions, the SmartAXIS can execute only one instruction each of RXD2 through RXD3 at a time. If the start input for a RXD2 through RXD3 instruction is turned on while another RXD2 through RXD3 instruction, without a start delimiter is executed, a user communication error occurs.
- Since RXD instructions are executed in each scan while input is on, a pulse input from a SOTU or SOTD instruction should be used.
- Once the input to the RXD instruction is turned on, the RXD is activated and ready for receiving incoming communication even after the input is turned off. When the RXD completes data receiving, the RXD is deactivated if the input to the RXD is off. Or, if the input is on, the RXD is made ready for receiving another communication. Special internal relays are available to deactivate all RXD instructions waiting for incoming communication. For user communication receive instruction cancel flags, see "User Communication Receive Instruction Cancel Flag" on page 25-20.

User Communication Receive Instruction Dialog Box in WindLDR

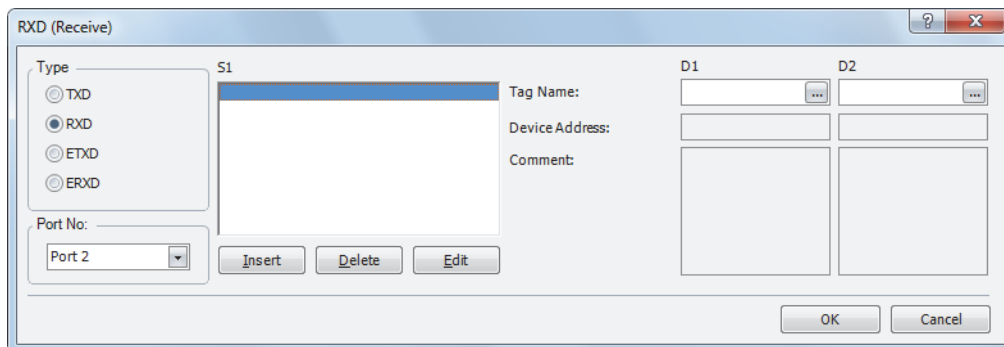

Selections and Devices in Receive Instruction Dialog Box

| | | |
|-------------|------------------------|--|
| Type | TXD | Transmit instruction |
| | RXD | Receive instruction |
| Port | Port 2 - Port 3 | Receive user communication to port 2 (RXD2) through port 3 (RXD3) |
| S1 | Source 1 | Enter the receive format in this area. The receive format can include a start delimiter, data register to store incoming data, constants, end delimiter, BCC, and skip. |
| D1 | Destination 1 | Receive completion output can be an output or internal relay. |
| D2 | Destination 2 | Receive status register can be data register D0-D1998. The next data register stores the byte count of received data. |

Receive Format

Receive format, designated by source device S1, specifies data registers to store received data, data digits for storing data, data conversion type, and repeat cycles. A start delimiter and an end delimiter can be included in the receive format to discriminate valid incoming communication. When some characters in the received data are not needed, "skip" can be used to ignore a specified number of characters. BCC code can also be appended to the receive format to verify the received data. One RXD instruction can receive 200 bytes of data at the maximum.

S1 (Source 1)

| Receive Format | Device | Receive Digits (Bytes) | Conversion Type | Repeat | BCC Calculation | Calculation Start Position | Skip Bytes | Delimiter |
|----------------------------------|-------------------------|------------------------|--|--------|---|----------------------------|------------|--------------|
| Data Register | D0-D1999 | 1-4 1-5 1-2 | A:ASCII to Binary B:ASCII to BCD -:No conversion | 1-99 | — | — | — | Hex ASCII |
| Start Delimiter | 00h-FFh 1 to 5 bytes | — | No conversion | — | — | — | — | |
| End Delimiter | 00h-FFh | — | No conversion | — | — | — | — | |
| Constant for Verification | 00h-FFh | — | No conversion | — | — | — | — | |
| BCC | — | 1-2 | A:Binary to ASCII -:No conversion | — | X:XOR A:ADD C:Add-2comp M:Modbus ASCII M:Modbus RTU | 1-15 | — | |
| Skip | — | — | — | — | — | — | 1-99 | |

Note: Total byte count of the receive format is shown in S1 of RXD instruction on the ladder diagram of WindLDR.

Designating Data Register as S1

When a data register is designated as source device S1, receive digits and conversion type must also be assigned. The received data is divided into blocks of specified receive digits, converted in a specified conversion type, and stored to the designated data registers. Conversion types are available in ASCII to Binary, ASCII to BCD, and no conversion.

When repeat is designated, received data is divided, converted, and stored into as many data registers as the repeat cycles, starting with the designated data register. There can be up to 99 repeat cycles.

When a data register is designated as source device S1, a delimiter can be included in the data register designation to end receiving communication.

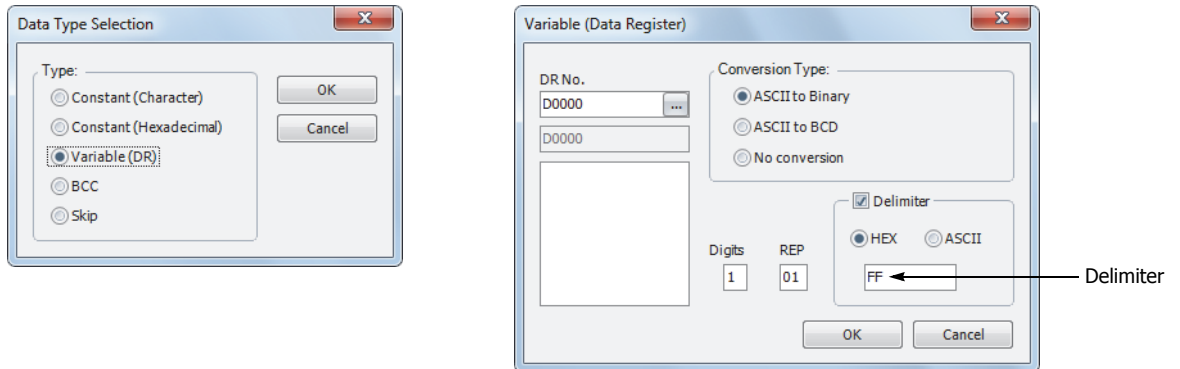

Receive Digits

The received data is divided into blocks of specified receive digits before conversion as described below:

Example: Received data of 6 bytes are divided in different receive digits. (Repeat is also designated.)

(1) Receive digits = 2

(2) Receive digits = 3

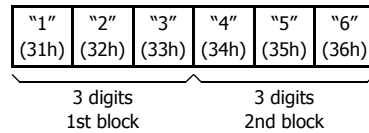
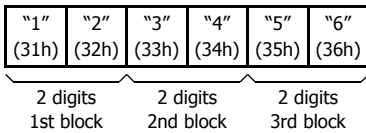

Conversion Type

The data block of the specified receive digits is then converted according to the designated conversion type as described below:

Example: Received data has been divided into a 2-digit block.

(1) ASCII to Binary conversion

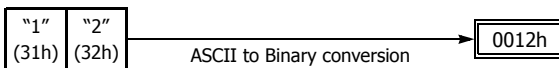

(2) ASCII to BCD conversion

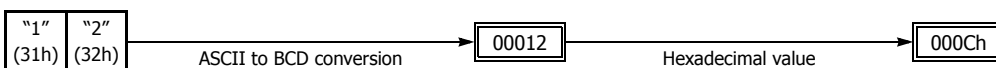

(3) No conversion

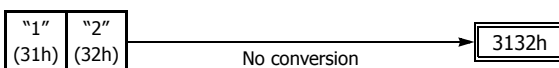

25: USER COMMUNICATION INSTRUCTIONS

Repeat Cycles

When a data register is assigned to repeat, the received data is divided and converted in the same way as specified, and the converted data is stored to as many consecutive data registers as repeat cycles.

Example: Received data of 6 bytes is divided into 2-digit blocks, converted in ASCII to Binary, and stored to data registers starting at D20.

(1) Repeat cycles = 2

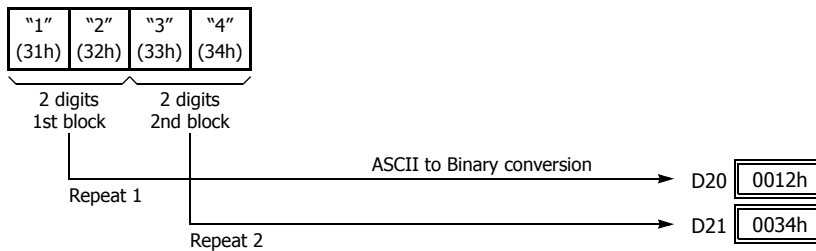

(2) Repeat cycles = 3

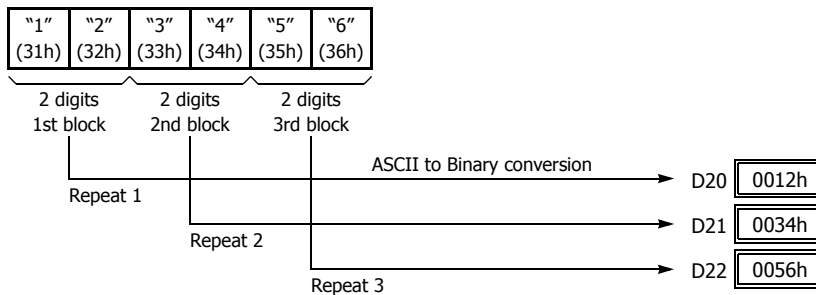

Delimiter

A delimiter for the data register in the receive format can be assigned. Using a delimiter, incoming data of variable length can be received and stored to data registers.

| Delimiter | How the incoming data is stored to data registers |
|---------------------|--|
| Designated | The incoming data is stored to data registers until all the data specified with receive digits, conversion type, and repeat is processed or the specified delimiter is received. |
| No delimiter | The incoming data is stored to data registers until all the data specified with receive digits, conversion type, and repeat is processed. |

Note: Delimiters for data registers can be used in the receive format of RXD instructions only.

Designating Constant as Start Delimiter

A start delimiter can be programmed at the first byte in the receive format of a RXD instruction; the SmartAXIS will recognize the beginning of valid communication, although a RXD instruction without a start delimiter can also be executed.

When a constant value is designated at the first byte of source device S1, the one-byte data serves as a start delimiter to start the processing of the received data.

A maximum of five instructions each of RXD2 through RXD3 with different start delimiters can be executed at the same time. When the first byte of the incoming data matches the start delimiter of a RXD instruction, the received data is processed and stored according to the receive format specified in the RXD instruction. If the first byte of the incoming data does not match the start delimiter of any RXD instruction that is executed, the SmartAXIS discards the incoming data and waits for the next communication.

When a RXD instruction without a start delimiter is executed, any incoming data is processed continuously according to the receive format. Only one instruction each of RXD2 through RXD3 without a start delimiter can be executed at a time. If start inputs to two or more RXD instructions without a start delimiter are turned on simultaneously, the one at the smallest address is executed and the corresponding completion output is turned on.

Example:

(1) When a RXD instruction without a start delimiter is executed

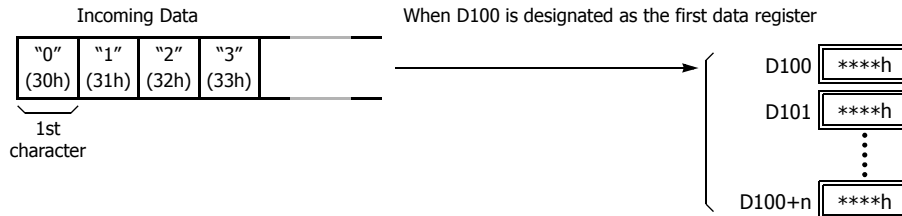

The incoming data is divided, converted, and stored to data registers according to the receive format.

(2) When RXD instructions with start delimiters STX (02h) and ENQ (05h) are executed

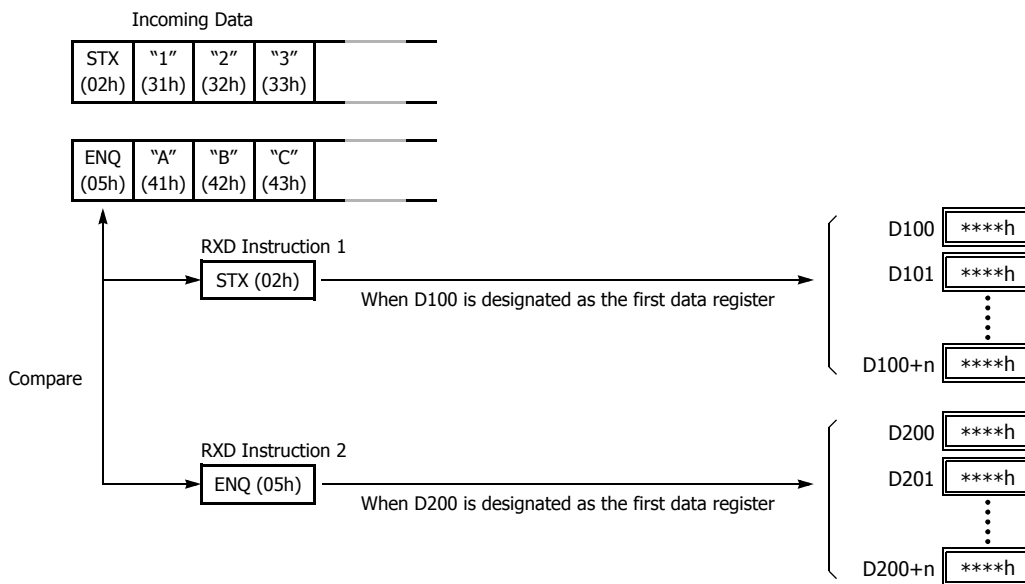

The incoming data is divided, converted, and stored to data registers according to the receive format. Start delimiters are not stored to data registers.

Multi-byte Start Delimiter

A start delimiter can be programmed at the first bytes in the receive format of a RXD instruction; the SmartAXIS will recognize the beginning of valid communication, although a RXD instruction without a start delimiter can also be executed. A maximum of 5 consecutive constants that are either character or hexadecimal from the first byte of the receive format are considered a multi-byte start delimiter.

If a RXD instruction with a start delimiter is executed and another RXD instruction with the same start delimiter is executed, user communication error code 5 is stored in the data register designated as the receive status of the second RXD instruction. When the error occurs, the second RXD instruction is canceled, and the first RXD instruction executed is kept.

If a multi-byte start delimiter is assigned, and the incoming data does not match the entire multi-byte start delimiter, the SmartAXIS discards the incoming data and waits for the next communication.

When the first one byte is received, a timer is started to monitor the interval between incoming data even when a multi-byte start delimiter is assigned. If data is not received in the period specified for the receive timeout value after receiving one byte of data, a receive timeout error occurs, and user communication error code 11 is stored in the status data register.

25: USER COMMUNICATION INSTRUCTIONS

Examples: Multi-byte Start Delimiter

Multi-byte start delimiter is determined in the structure of the Receive Format. The following examples show how multi-byte start delimiter is determined.

- Constants are followed by data register, skip, or BCC

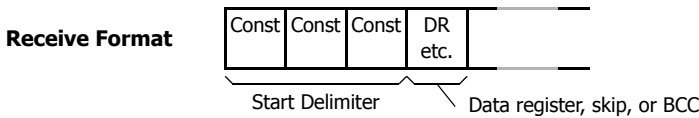
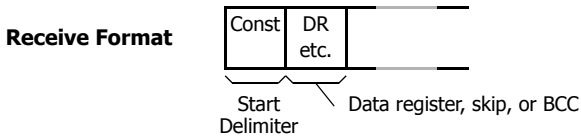

Note: Constants following data register, skip, or BCC are not considered start delimiter even if these are in the first five bytes of the receive format.

- More than 5 constants are specified from the first byte

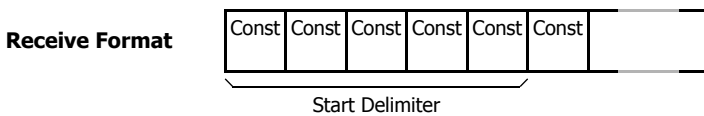

Note: Constants that are neither start delimiters or end delimiters are considered constants for verification. See "Constant for Verification" on page 25-15.

Example: Start Delimiter Duplication Error

When input I0 is turned on, the first RXD instruction is executed and status code 32 is stored in the receive status D200, indicating the RXD instruction is waiting for the incoming data. When input I1 is turned on, another RXD instruction is executed, but since two RXD instructions have the same start delimiter, the second RXD instruction is not executed, and user communication error code 5 is stored in the receive status D300.

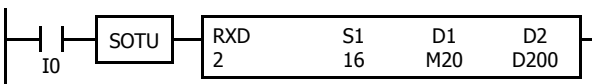

Receive Format S1

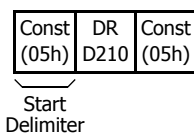

Communication port: Port 2
 Receive completion output: M20
 Receive status register: D200
 Receive data byte count: D201

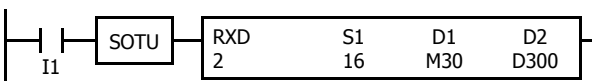
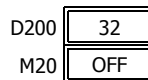

Receive Format S1

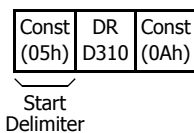

Communication port: Port 2
 Receive completion output: M30
 Receive status register: D300
 Receive data byte count: D301

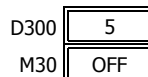

Note: If you execute two or more RXD instructions with multi-byte start delimiters simultaneously, the start delimiters of those RXD instructions must be unique from the others. When the length of the multi-byte start delimiters of the RXD instructions is different, the length of the shortest one is applied to check the duplicated start delimiters. The start delimiter of any of two RXD instructions in the following RXD instructions are considered the same.

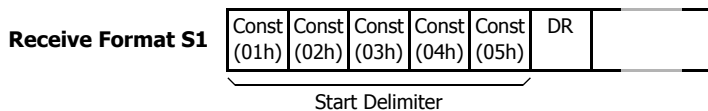
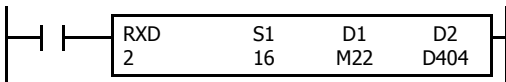
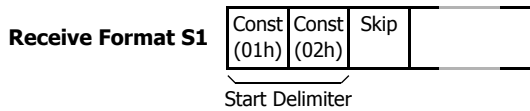
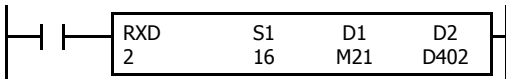
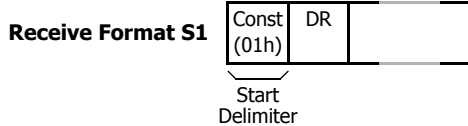
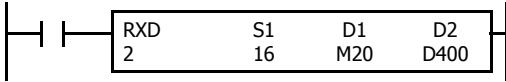

Example: Using Multi-byte Start Delimiter

The following example shows the advantages of using a multi-byte start delimiter rather than a single-byte start delimiter. A RXD instruction processes incoming data from the master station. The incoming data is sent to multiple slave stations 0 through 9, and the local slave station number is 1. Therefore, incoming data from the master station must be received only when the incoming data is sent for the slave station 1.

• **Incoming data**

Incoming data consists of start delimiter STX, a slave station number which can be 0 through 9, data 0000 through 9999, and end delimiter CR.

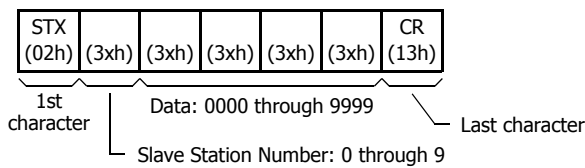

• **Single-byte start delimiter**

Only the first byte can be the start delimiter. The second byte of the incoming data, which is the slave station number, has to be stored to data register D0, and extra ladder programming is needed to see whether the slave station number of the incoming communication is 1 or not. Only when the slave station number is 1, received data stored in D1 is valid for the local PLC.

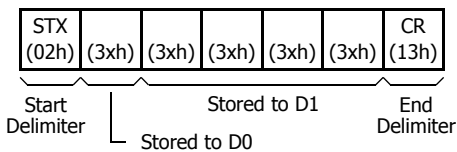

• Multi-byte start delimiter

First two bytes can be configured as a multi-byte start delimiter. The incoming data is processed according to the receive format only when the first two bytes of the incoming data match the start delimiter. Therefore, only the incoming data sent to slave station 1 is processed. No extra ladder programming is needed to check the slave station number.

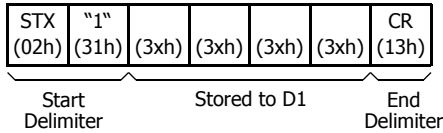

Designating Constant as End Delimiter

An end delimiter can be programmed at the end of the receive format of a RXD instruction; the SmartAXIS will recognize the end of valid communication, although RXD instructions without an end delimiter can also be executed.

When a constant value is designated at the end of source device S1, the one-byte data serves as an end delimiter to end the processing of the received data. End delimiters can be 00h through FFh. Constant values are entered in character or hexadecimal notation into the source device. When using the same RXD instruction repeatedly in a user program, assign different end delimiters for each RXD instruction.

If a character in incoming data matches the end delimiter, the RXD instruction ends receiving data at this point and starts subsequent receive processing as specified. Even if a character matches the end delimiter at a position earlier than expected, the RXD instruction ends receiving data there.

If a BCC code is included in the receive format of a RXD instruction, an end delimiter can be positioned immediately before or after the BCC code. If a data register or skip is designated between the BCC and end delimiter, correct receiving is not ensured.

When a RXD instruction without an end delimiter is executed, data receiving ends when the specified bytes of data in the receive format, such as data registers and skips, have been received. In addition, data receiving also ends when the interval between incoming data characters exceeds the receive timeout value specified in the Communication Parameters dialog box whether the RXD has an end delimiter or not. The character interval timer is started when the first character of incoming communication is received and restarted each time the next character is received. When a character is not received within a predetermined period of time, timeout occurs and the RXD ends data receive operation.

Example:

(1) When a RXD instruction without an end delimiter is executed

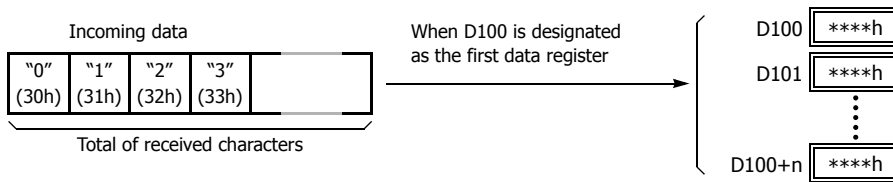

The incoming data is divided, converted, and stored to data registers according to the receive format. Receive operation is completed when the total characters programmed in RXD are received.

(2) When a RXD instruction with end delimiter ETX (03h) and without BCC is executed

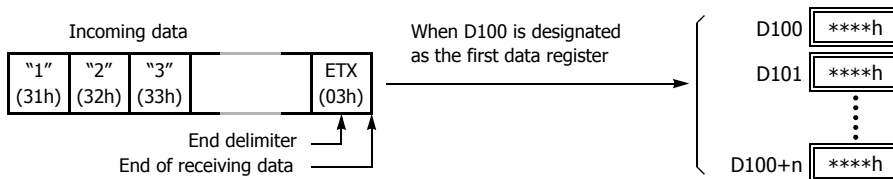

The incoming data is divided, converted, and stored to data registers according to the receive format. The end delimiter is not stored to a data register. Any data arriving after the end delimiter is discarded.

(3) When a RXD instruction with end delimiter ETX (03h) and one-byte BCC is executed

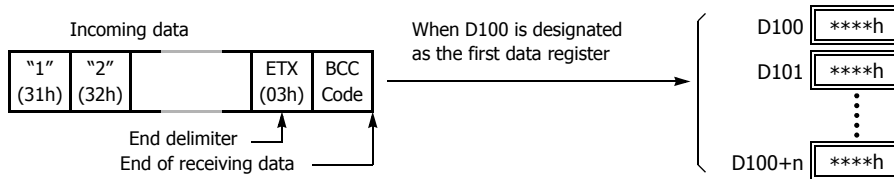

The incoming data is divided, converted, and stored to data registers according to the receive format.
 The end delimiter and BCC code are not stored to data registers.
 After receiving the end delimiter, the SmartAXIS receives only the one-byte BCC code.

Constant for Verification

Constants excluding start and end delimiters can be configured in the receive format to verify the incoming data with the constants, which are either characters or hexadecimal values. As many constants can be configured for the verification as required. The verification result is stored in the receive status of the RXD instruction.

Example: Programming Constant for Verification

The following example shows the advantage of using constant for verification. The incoming data contains a constant value "1" in the middle, and that constant value needs to be verified to see whether the incoming data is valid.

• **Using Data Register**

The incoming data including the constant value needs to be stored in data registers. When the RXD instruction completes receiving the incoming data, the receive status contains 64, meaning the RXD instruction has completed without errors, even if the constant value is not an expected value. Extra ladder programming is needed to see whether the constant value in the incoming data is correct or not.

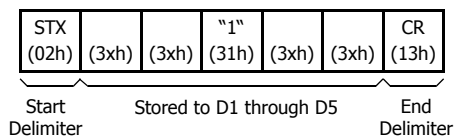

• **Using Constant for Verification**

A constant to verify the constant value in the incoming data is designated in the receive format. If the constant value is not an expected value when the RXD instruction completes receiving the incoming data, the receive status contains 74, meaning the RXD instruction has completed but user communication error code 5 occurred. No extra ladder programming is needed to see whether the constant value in the received data is correct or not.

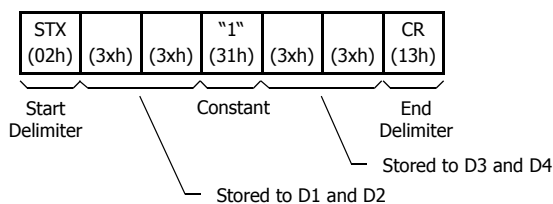

Note: When configuring constants, which are either characters or hexadecimal values, in the receive format, and the incoming data does not match the constants in the receive format, then a user communication error code is stored in the receive status. The error code contained in the receive status depends on whether the constants are used as a start delimiter or as constants for verification. If used as a start delimiter, user communication error code 7 is stored in the receive status, and the RXD instruction keeps waiting for valid incoming data. On the other hand, if used as constants for verification, the receive status contains 74, and the RXD instruction finishes the execution. To repeat receiving incoming communication, turn on the input for the RXD instruction.

25: USER COMMUNICATION INSTRUCTIONS

- Start delimiter of incoming data does not match the receive format

| | | | | | | | |
|----------------|-------------|-------|-------------|-------|-------------|----------------------------|---|
| Incoming Data | Const (02h) | (xxh) | (FFh) | (xxh) | (0Dh) | | |
| Receive Format | Const (05h) | DR | Const (FFh) | DR | Const (0Dh) | Receive status: | 7 |
| | | | | | | Receive completion output: | 0 |

Start Delimiter

RXD instruction keeps waiting for valid incoming data, and completes data receiving after receiving valid data including a correct start delimiter.

- Constant for verification of incoming data does not match the receive format

| | | | | | | | |
|----------------|-------------|-------|-------------|-------|-------------|----------------------------|----|
| Incoming Data | (05h) | (xxh) | (0Fh) | (xxh) | (0Dh) | | |
| Receive Format | Const (05h) | DR | Const (FFh) | DR | Const (0Dh) | Receive status: | 74 |
| | | | | | | Receive completion output: | 1 |

Constant for Verification

Receive status stores 74 (= 64 + 10)
RXD instruction completes data receiving. To repeat receiving incoming communication, turn on the input for the RXD instruction.

Note: Constants configured in the beginning of receive formats have different functions as shown below:

- More than five constants are configured in the beginning of the receive format

| | | | | | | | | |
|----------------|-------|-------|-------|-------|-------|-------|--|-------|
| Byte | 1st | 2nd | 3rd | 4th | 5th | 6th | | 200th |
| Receive Format | Const | Const | Const | Const | Const | Const | | Const |

Start Delimiter Up to 5th byte Constant for Verification 6th byte and after

- Other than constants (data register, skip, or BCC) are included in the first five bytes of the receive format

| | | | | | | | | |
|----------------|-------|---------|-------|-------|-------|-----|--|-------|
| Byte | 1st | 2nd | 3rd | 4th | 5th | 6th | | 200th |
| Receive Format | Const | DR etc. | Const | Const | Const | | | |

Start Delimiter Consecutive first 5 bytes only Data register, skip, or BCC Constant for Verification Not consecutive in the first 5 bytes

Skip

When "skip" is designated in the receive format, a specified quantity of digits in the incoming data are skipped and not stored to data registers. A maximum of 99 digits (bytes) of characters can be skipped continuously.

Example: When a RXD instruction with skip for 2 digits starting at the third byte is executed

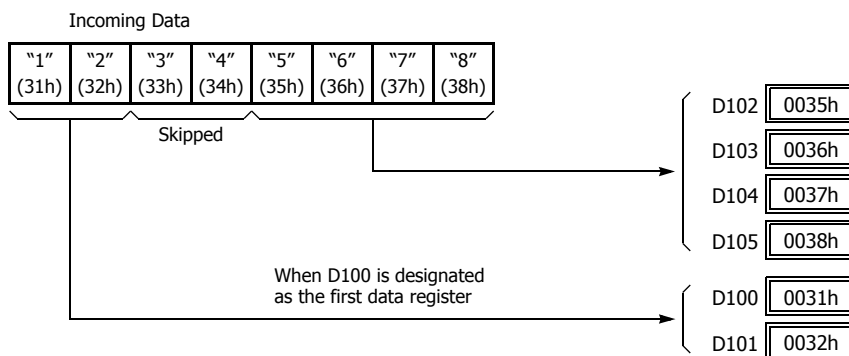

BCC (Block Check Character)

The SmartAXIS has an automatic BCC calculation function to detect a communication error in incoming data. If a BCC code is designated in the receive format of a RXD instruction, the SmartAXIS calculates a BCC value for a specified starting position through the position immediately preceding the BCC. It then compares the calculation result with the BCC code in the received incoming data. The start position for the BCC calculation can be specified from the first byte through the 15th byte. The BCC can be 1 or 2 digits.

When an end delimiter is not used in the RXD instruction, the BCC code must be positioned at the end of the receive format designated in Source 1 device. When an end delimiter is used, the BCC code must be immediately before or after the end delimiter. The SmartAXIS reads a specified number of BCC digits in the incoming data according to the receive format to calculate and compare the received BCC code with the BCC calculation results.

BCC Calculation Start Position

The start position for the BCC calculation can be specified from the first byte through the 15th byte. The BCC is calculated for the range starting at the designated position up to the byte immediately before the BCC of the receive data.

Example: Received data consists of 17 bytes plus 2 BCC digits.

(1) Calculation start position = 1

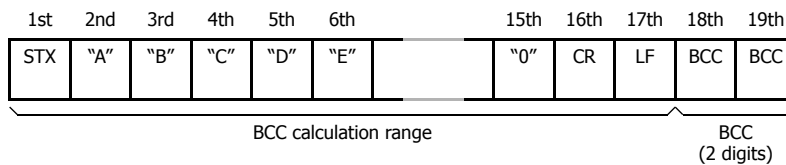

(2) Calculation start position = 2

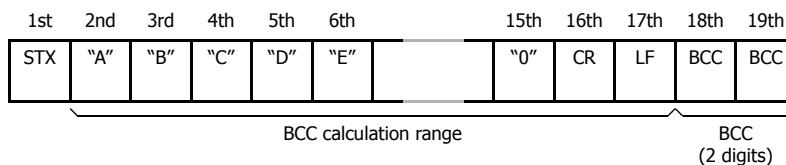

BCC Calculation Formula

BCC calculation formula can be selected from XOR (exclusive OR), ADD (addition), ADD-2comp, Modbus ASCII, or Modbus RTU.

Example: Incoming data consists of 41h, 42h, 43h, and 44h.

(1) BCC calculation formula = XOR

Calculation result = 41h ⊕ 42h ⊕ 43h ⊕ 44h = 04h

(2) BCC calculation formula = ADD

Calculation result = 41h + 42h + 43h + 44h = 10Ah → 0Ah (Only the last 1 or 2 digits are used as BCC.)

(3) BCC calculation formula = ADD-2comp

Calculation result = FEh, F6h (2 digits without conversion)

(4) BCC calculation formula = Modbus ASCII

Calculation result = 88 (ASCII)

(5) BCC calculation formula = Modbus RTU

Calculation result = 85h 0Fh (binary)

25: USER COMMUNICATION INSTRUCTIONS

Conversion Type

The BCC calculation result can be converted or not according to the assigned conversion type as described below:

Example: BCC calculation result is 0041h.

(1) Binary to ASCII conversion

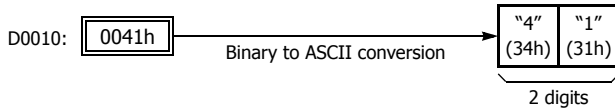

Note: On WindLDR, Modbus ASCII defaults to binary to ASCII conversion.

(2) No conversion

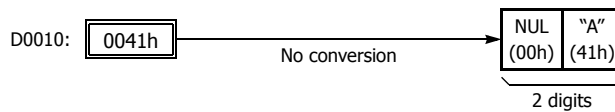

Note: On WindLDR, Modbus RTU defaults to no conversion.

BCC Digits (Bytes)

The quantity of digits (bytes) of the BCC code can be selected from 1 or 2.

Example:

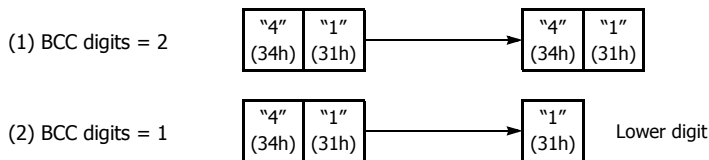

Note: On WindLDR, Modbus ASCII and Modbus RTU default is set to 2 digits.

Comparing BCC Codes

The SmartAXIS compares the BCC calculation result with the BCC code in the received incoming data to check for any error in the incoming communication due to external noises or other causes. If a disparity is found in the comparison, an error code is stored in the data register designated as receive status in the RXD instruction. For user communication error code, see Chapter 10 "User Communication Instructions" - "User Communication Error" in the SmartAXIS Pro/Lite User's Manual.

Example 1: BCC is calculated for the first byte through the sixth byte using the XOR format, converted in binary to ASCII, and compared with the BCC code appended to the seventh and eighth bytes of the incoming data.

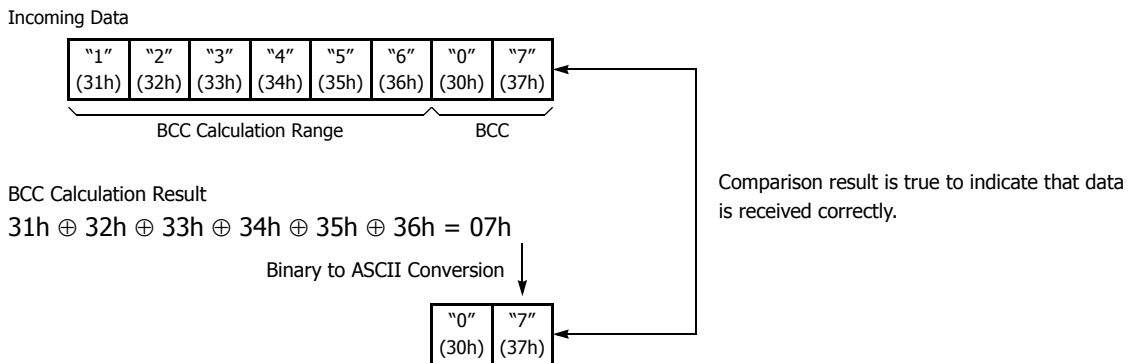

Example 2: BCC is calculated for the first byte through the sixth byte using the ADD format, converted in binary to ASCII, and compared with the BCC code appended to the seventh and eighth bytes of the incoming data.

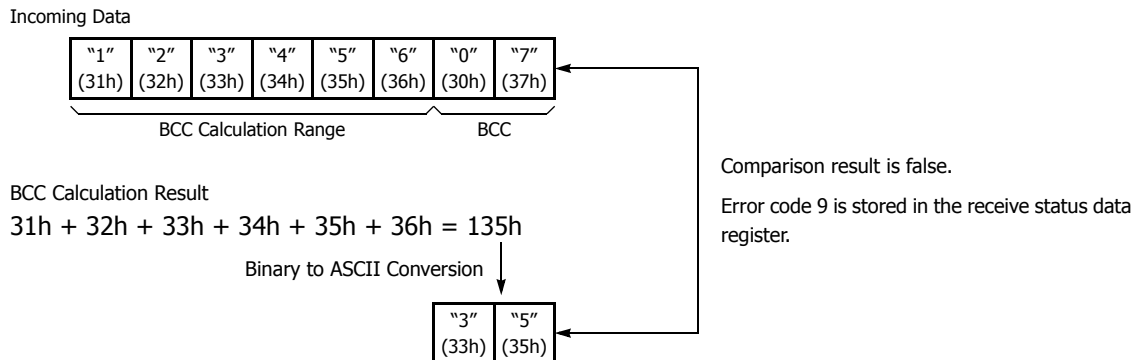

Receive Completion Output

Designate an output, Q0 through Q21, or internal relay, M0 through M1277, as a device for the receive completion output.

When the start input for a RXD instruction is turned on, preparation for receiving data is initiated, followed by data conversion and storage. When the data receive operation sequence is complete, the designated output or internal relay is turned on.

Conditions for Completion of Receiving Data

After starting to receive data, the RXD instruction can be completed in three ways depending on the designation of end delimiter and delimiter in the receive format.

| End Delimiter | Delimiter | Conditions for Completion of Receiving Data |
|---------------|-----------------|--|
| With | With or Without | When a specified byte count of data (digits × repeat) has been received or when an end delimiter is received. When a BCC exists immediately after the end delimiter, the BCC is received before ending data receiving. |
| Without | With | After the last constant (including delimiter) designated in the RXD instruction has been received, data receiving is completed when the subsequent byte count of data has been received. |
| Without | Without | When a specified byte count of data (digits × repeat) has been received. |

Note: Whenever a receive timeout has occurred, data receiving stops arbitrarily.

Data receiving is complete when one of the above three conditions is met. To abort a RXD instruction, use the special internal relay for user communication receive instruction cancel flag. See "User Communication Receive Instruction Cancel Flag" on page 25-20.

Example: A RXD instruction does not have an end delimiter and has a delimiter programmed in the receive format for data registers.

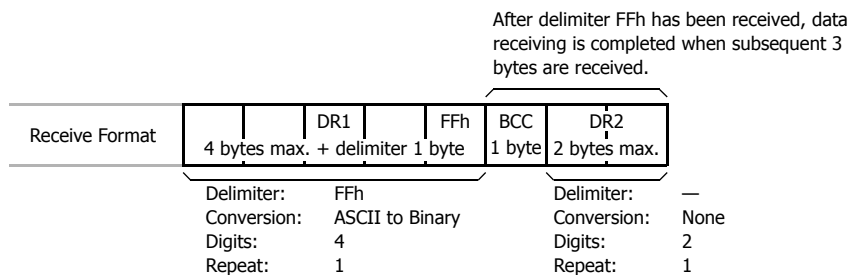

25: USER COMMUNICATION INSTRUCTIONS

Receive Status

Designate a data register, D0-D1998, as a device to store the receive status information including a receive status code and a user communication error code.

Receive Status Code

| Receive Status Code | Status | Description |
|---------------------|---|---|
| 16 | Preparing data receive | From turning on the start input for a RXD instruction to read the receive format, until the RXD instruction is enabled by an END processing |
| 32 | Receiving data | From enabling the RXD instruction by an END processing, until incoming data is received |
| 48 | Data receive complete | From receiving incoming data, until the received data is converted and stored in data registers according to the receive format |
| 64 | Receive instruction complete | All data receive operation is completed and the next data receive is made possible |
| 128 | User communication receive instruction cancel flag active | RXD instructions are cancelled by special internal relay for user communication receive instruction cancel flag, such as M8022 or M8023 |

If the receive status code is other than shown above, a receive instruction error is suspected. See Chapter 10 "User Communication Instructions" - "User Communication Error" in the SmartAXIS Pro/Lite User's Manual.

Receive Data Byte Count

The data register next to the device designated for receive status stores the byte count of data received by the RXD instruction. When a start delimiter, end delimiter, and BCC are included in the received data, the byte counts for these codes are also included in the receive data byte count.

Example: Data register D200 is designated as a device for receive status.

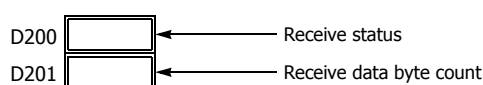

User Communication Receive Instruction Cancel Flag

Special internal relays for user communication receive instruction cancel flag are used to cancel all RXD instructions for each port. While the SmartAXIS has completed receive format and is ready for receiving incoming data, turning on the user communication receive instruction cancel flag cancels all RXD instructions for each port. This function is useful to cancel receive instructions only, without stopping the SmartAXIS.

To make the cancelled RXD instructions active, turn off the flag and turn on the input to the RXD instruction again.

| Device Address | Description | CPU Stopped | Power OFF | R/W |
|----------------|---|-------------|-----------|-----|
| M8022 | User Communication Receive Instruction Cancel Flag (Port 2) | Cleared | Cleared | W |
| M8023 | User Communication Receive Instruction Cancel Flag (Port 3) | Cleared | Cleared | W |

"R/W" is the abbreviation for read/write. When R/W, it can be read and written. When R, it can only be read. When W, it can only be written.

ETXD (User Communication Transmit over Ethernet)

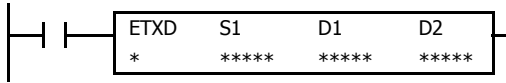

The ETXD instruction converts transmission data to the specified data type and sends it to the external device connected over Ethernet.

Applicable SmartAXIS

| FT1A-12 | FT1A-24 | FT1A-40 | FT1A-48 | FT1A-Touch |
|---------|---------|---------|---------|------------|
| — | X | X | X | — |

When the input is on, the transmission data designated by S1 is transmitted to the device connected with the specified connection.

When transmission is complete, the device designated by D1 is turned on. Transmit status (the transmission status and error code) is stored to the device designated by D2.

The byte count of transmitted data is stored to D2+1.

Apart from the connection settings, the settings of ETXD and TXD instructions are the same. For details on TXD instruction, see "TXD (Transmit)" on page 25-1.

The ETXD instruction cannot be used in an interrupt program.

If used, a user program execution error will result, turning on special internal relay M8004 and the ERR LED on the SmartAXIS. For details about the user program execution errors, see "User Program Execution Errors" on page 4-13.

Note: For details on the user communication client and user communication server specifications and for details on user communication over Ethernet, see Chapter 10 "User Communication" - "User Communication over Ethernet" in the SmartAXIS Pro/Lite User's Manual.

ERXD (User Communication Receive over Ethernet)

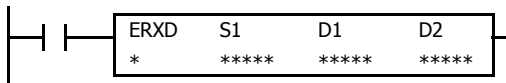

The ERXD instruction receives data from an external device connected over Ethernet, converts the received data in the specified format, and stores the converted data to data registers.

Applicable SmartAXIS

| FT1A-12 | FT1A-24 | FT1A-40 | FT1A-48 | FT1A-Touch |
|---------|---------|---------|---------|------------|
| — | X | X | X | — |

When the input is on, the received data designated by S1 is received from the device connected with the specified connection.

When all data has been received, the device designated by D1 is turned on. Receive status (the receive status and error code) is stored to the device designated by D2.

The byte count of received data is stored to D2+1.

When user communication receive instruction cancel flag (M8100, M8101, M8102) is turned on while receiving incoming data, the execution of all active receive instructions for the corresponding connection is canceled.

Apart from the connection settings and the allocation of the user communication receive instruction cancel flags, the settings of ERXD and RXD instructions are the same. For details on RXD instruction, see "RXD (Receive)" on page 25-7.

The ERXD instruction cannot be used in an interrupt program.

If used, a user program execution error will result, turning on special internal relay M8004 and the ERR LED on the SmartAXIS. For details about the user program execution errors, see "User Program Execution Errors" on page 4-13.

Note: For details on the user communication client and user communication server specifications and for details on user communication over Ethernet, see Chapter 10 "User Communication" - "User Communication over Ethernet" in the SmartAXIS Pro/Lite User's Manual.

26: DATA LOG INSTRUCTIONS

Introduction

The data log instructions save log data for specified devices to the SD memory card.

DLOG (Data Log)

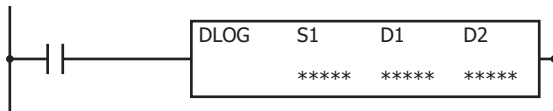

The DLOG instruction saves the values of the specified devices in the specified data format as a CSV file on the SD memory card.

When the input is on, the date and time and the values of the specified devices are output to the CSV file in the folder assigned by S1. When the execution of the instruction finishes, the device assigned by D1 is turned on and the execution status is stored to the device assigned by D2.

When the folder assigned by S1 does not exist on the SD memory card, that folder is created. The folder path is "DATA0001\DATALOG\User specified folder." For details on the folder structure, see Chapter 5 "Special Functions" - "SD Memory Card" in the SmartAXIS Pro/Lite User's Manual.

The CSV file name is "DATE.csv." The date when the DLOG instruction is turned on is used as DATE.

Example: If the date is September 30, 2011, the file name is "20110930.csv".

When a CSV file with the same date does not exist in the folder designated by S1, the CSV file is created and the header and the log data is output.

Output example

| | | |
|---------------------|-------|------------|
| Time | D0010 | ← Header |
| 2011/09/07 08:30:23 | 12345 | ← Log data |

When a CSV file with the same date already exists in the folder designated by S1, only the log data is appended to the CSV file.

Output example

| | | |
|---------------------|-------|---------------------|
| Time | D0010 | |
| 2011/09/07 08:30:23 | 12345 | |
| 2011/09/07 17:30:23 | 1212 | ← Appended log data |

When the execution of DLOG instruction finishes, the device designated by D1 is turned on and the status code is stored to the device designated by D2 according to the execution result. For status codes, see "3. D2 (destination 2): Execution status" on page 26-3.

Notes:

- The time required to create a new CSV file (create a file and output header) is 510 μs.
- When the SmartAXIS starts running and DLOG instruction is executed, the header is appended to the CSV file even if the same DLOG instruction was executed previously within the same day.

Output example

| | | |
|---------------------|-------|-------------------|
| Time | D0010 | ← Header |
| 2011/09/07 08:30:23 | 12345 | ← Log data |
| Time | D0020 | ← Appended header |
| 2011/09/07 17:30:23 | 1212 | ← Log data |

- For details on the SD memory card specification, see Chapter 5 "Special Functions" – "SD Memory Card" in the SmartAXIS Pro/Lite User's Manual.

26: DATA LOG INSTRUCTIONS

Notes:

- The number of DLOG instructions that can be programmed in a user program is 48. However, make sure that the folder name specified by the DLOG instruction is not duplicated by any folder names specified by the other DLOG instructions. When the folders are duplicated, log data with a mixed format is output to the same CSV file.
- The DLOG instruction cannot be used in an interrupt program. If used, a user program execution error will result, turning on special internal relay M8004 and the ERR LED on the SmartAXIS. For details about the user program execution errors, see "User Program Execution Errors" on page 4-13.
- While the input to DLOG instruction is on, log data is repeatedly output to the CSV file. When you want to output the log data only one time, add a SOTU (single output up instruction) or SOTD (single output down instruction) to the input condition. For SOTU or SOTD, see "SOTU and SOTD (Single Output Up and Down)" on page 5-26.
- The process of writing data to the SD memory card for the DLOG instruction takes several scans. Once a DLOG instruction is executed, the process continues until the log data transfer is complete, regardless of any change in the instruction input. While the log data is being written to the SD memory card, instructions are not being executed, even when the inputs to DLOG instructions are turned on. To execute the DLOG instruction again, confirm that the previous data transfer process has finished, and then execute the instruction.

Applicable SmartAXIS

| FT1A-12 | FT1A-24 | FT1A-40 | FT1A-48 | FT1A-Touch |
|---------|---------|---------|---------|------------|
| — | — | X | X | — |

Valid Devices

| Device | Function | I | Q | M | R | T | C | D | Constant | Repeat |
|--------------------|--------------------|---|---|---|---|---|---|---|----------|--------|
| S1 (Source 1) | Folder name (Note) | — | — | — | — | — | — | — | — | — |
| D1 (Destination 1) | Completion output | — | X | ▲ | — | — | — | — | — | — |
| D2 (Destination 2) | Execution status | — | — | — | — | — | — | ▲ | — | — |

Note: Specify the folder name by entering characters.

▲ Special internal relays cannot be designated as D1. Special data registers cannot be designated as D2.

Settings

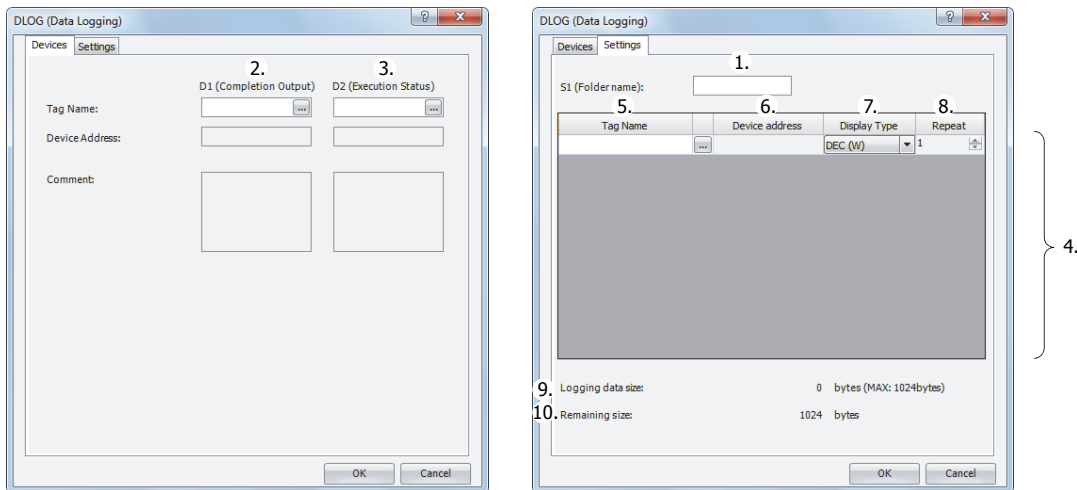

1. S1 (source 1): Folder name

Specify the folder name on the SD memory card to store the log data with a desired text up to 8 single-byte alphanumeric characters.

Notes:

- The following single-byte characters cannot be used in the folder names:
/\ : * ? " < > | # { } % & ~
- Consecutive periods cannot be used in folder names.
- A period cannot be used at the start or the end of the folder name.
- Single-byte spaces at the start or the end of the folder name are omitted.

2. D1 (destination 1): Completion output

Specify the device that turns on when the transfer of log data to a SD card and the execution of the DLOG instruction are complete. This device is turned on regardless of the success or failure of transferring log data to the SD memory card.

3. D2 (destination 2): Execution status

Specify the device to store the status code. One of the following status codes is stored according to the DLOG instruction execution status and result.

| Status code | Status | Description |
|-------------|---------------------------------|--|
| 0 | Normal | — |
| 1 | SD memory card insertion error | The SD memory card is not inserted |
| 2 | SD memory card capacity error | The SD memory card is full |
| 3 | SD memory card writing error | Writing log data to the SD memory card fails |
| 4 | CSV file capacity error | The CSV file exceeds 5 MB |
| 5 | SD memory card protection error | The SD memory card is write protected |
| 6 | SD memory card access error | DLOG instruction is executed while another DLOG instruction or TRACE instruction is being executed |
| 7 | Characters conversion error | Converting log data to numeric characters fails |
| 8 | Folder creation error | Creating the folder fails |
| 9 | CSV file open error | Opening the CSV file fails |
| 32 | Executing DLOG instruction | Writing log data to SD memory card is in progress |

4. Settings

The following is a list of the device and display types that can be set as the data to be output to the CSV files.

| Display type | Valid Devices |
|--------------|-------------------|
| DEC(W) | TC, TP, CC, CP, D |
| DEC(I) | D |
| DEC(D) | CC, CP, D |
| DEC(L) | D |
| DEC(F) | D |
| HEX(W) | TC, TP, CC, CP, D |
| HEX(D) | CC, CP, D |
| BIN(B) | I, Q, M, R, T, C |

5. Tag Name

Enter tag names or device addresses to specify the devices whose values are output to the CSV files.

6. Device Address

When the devices are specified as tag names, the corresponding device addresses are shown.

7. Display Type

Select the display type from the following table for each device for when the device values are output to the CSV file.

| Display type | Range | Maximum characters |
|--------------|---------------------------------|--------------------|
| DEC(W) | 0 to 65,535 | 5 |
| DEC(I) | -32,768 to 32,767 | 6 |
| DEC(D) | 0 to 4,294,967,295 | 10 |
| DEC(L) | -2,147,483,648 to 2,147,483,647 | 11 |
| DEC(F) | -3.402823E+38 to 3.402823E+38 | 13 |
| HEX(W) | 0000 to FFFF | 4 |
| HEX(D) | 00000000 to FFFFFFFF | 8 |
| BIN(B) | 0 or 1 | 1 |

26: DATA LOG INSTRUCTIONS

8. Repeat

The data in as many consecutive devices as the specified repeat, starting from the specified device address, are output to the SD memory card.

For example, when the display type of D10 is DEC(W) and the repeat is set to 5, the data is output to SD memory card as follows.

| Time | D0010 | D0011 | D0012 | D0013 | D0014 | ← Header |
|---------------------|-------|-------|-------|-------|-------|--------------|
| 2011/09/07 15:40:00 | 12345 | 1 | 5 | 12 | 111 | ← Log data 1 |
| 2011/09/07 15:41:00 | 1212 | 3 | 7 | 35 | 222 | ← Log data 2 |
| 2011/09/07 15:42:00 | 345 | 4 | 99 | 79 | 333 | ← Log data 3 |

9. Logging data size

The amount of memory that the DLOG instruction uses for the current log settings is shown. The amount of memory used increases when a device to log the data is added. You can register up to a maximum of 64 devices (the total amount of memory must be less than or equal to 1,024 bytes). One byte of memory area is required for each character.

10. Remaining size

The amount of free memory (the difference between the logging data size and 1,024 bytes) is shown.

CSV File Output Format and File Format Configuration

The CSV file output format is as follows. You can change the separating character for each data and the decimal symbol for floating point numbers that are output to the CSV files on the Function Area Settings dialog box.

- **Output format**

```
Time,D0010,D0020,D0030,D0050,D0060
2011/09/07 15:40:00,12345,1,5,12,111
2011/09/07 15:41:00,1212,3,7,35,222
2011/09/07 15:42:00,345,4,99,79,333
:
:
```

When the DLOG instruction is executed and the CSV file for the same date does not exist in the folder designated by S1, a new CSV file is created and the header and the log data 1 are output as shown in above output format example. If the DLOG instruction is executed again on the same date, the log data 2 is appended to the CSV file. Similarly, if the DLOG instruction is executed again on the same date, log data 3 is appended to the CSV file.

When the date changes and the DLOG instruction is executed, a new CSV file with a new file name is created and the header and the log data is output.

File format configuration procedure

1. From the WindLDR menu bar, select **Configuration > Cartridges**.
2. Under **Data Log and Trace (CSV File Output)**, configure the separating character and the decimal symbol.
The separating characters and the decimal symbols that are contained in the CSV file vary by country and region. You can select the symbols to use from the following:
 - (1) Separating character: "," (comma) or ";" semicolon
 - (2) Decimal symbol: "." (period) or "," (comma)
3. Click the **OK** button to close the dialog box.

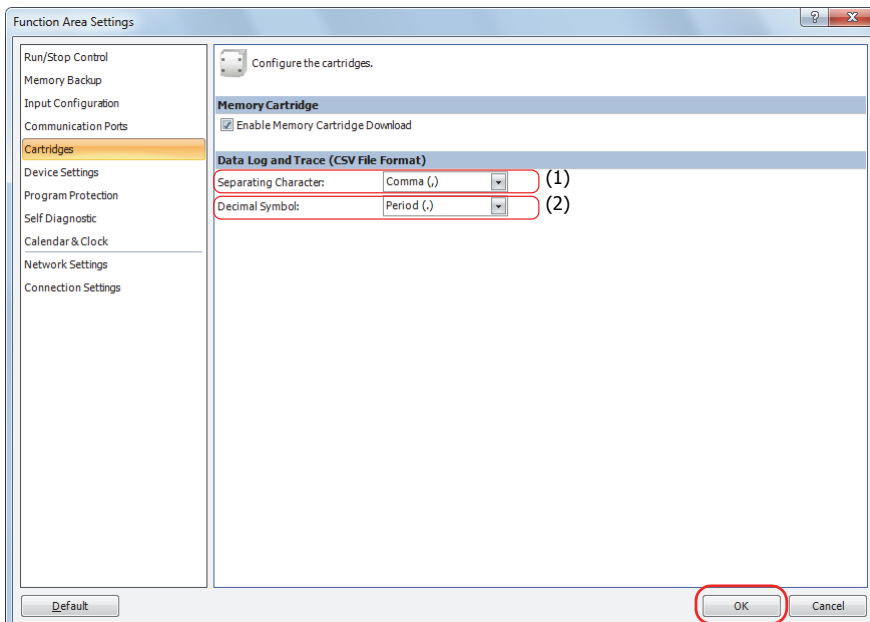

Examples: DLOG

When M0 is turned on, the decimal values of D0 through D5 (data type W (word)) and D10 (data type F (floating point)) are saved in a CSV file in the "RESULT" folder on the SD memory card every 10 seconds.

Output example

| Time | D0000 | D0001 | D0002 | D0003 | D0004 | D0005 | D0010 |
|---------------------|-------|-------|-------|-------|-------|-------|---------------|
| 2012/02/06 10:20:30 | 12345 | 0 | 0 | 56789 | 0 | 0 | -3.402823E+38 |
| 2012/02/06 10:20:40 | 12345 | 0 | 0 | 56789 | 0 | 0 | -3.402823E+38 |
| 2012/02/06 10:20:50 | 12345 | 0 | 0 | 56789 | 0 | 0 | -3.402823E+38 |

The sample user program described below operates as follows.

- M100 is turned on when the transfer of log data has finished transferring to the SD memory card is complete.
- The DLOG instruction status code is stored in D100.
- The status code saved in D100 is checked and Q0 is turned on if an error occurs.

• Configuration Procedure

1. Insert the instructions in the Ladder editor.

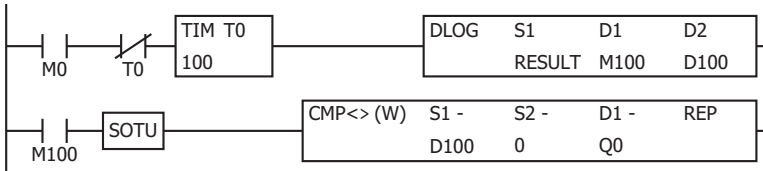

2. Configure the DLOG instruction.

Configure the Devices tab.

- (1) Designate M100 as D1 (Completion Output).
- (2) Designate D100 as D2 (Execution Status).

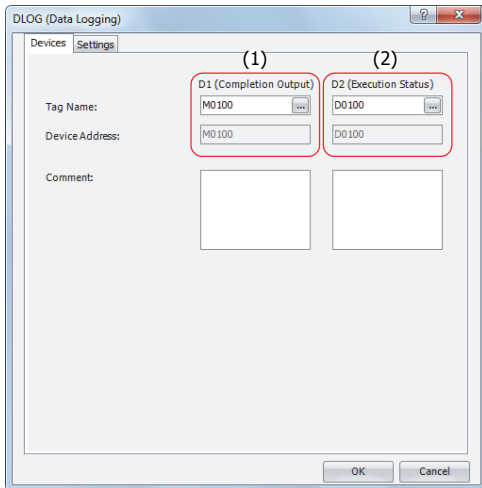

Configure the Settings tab.

- (3) Enter "RESULT" in S1 (Folder Name).
- (4) Configure D0 to output the decimal value of D0 to the CSV files with the data type W (word).
- (5) Set the repeat to 6 to output the values of D0 through D5 to the CSV files.
- (6) Configure D10 to output the decimal value of D10 to the CSV files with the data type F (float).

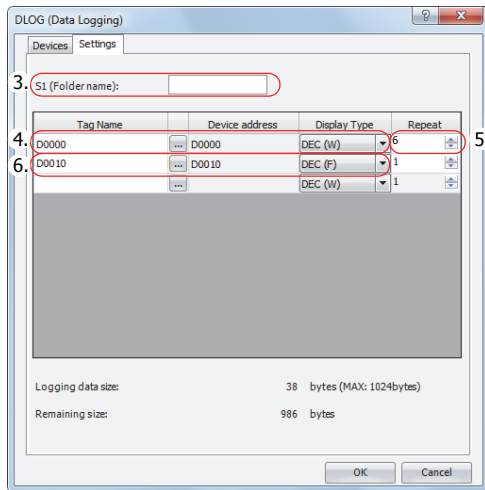

The configuration is now completed.

• **Operation Description**

10 seconds after M0 is turned on, the DLOG instruction is executed one time. When the DLOG instruction is executed, the data of D0 through D5 and D10 are output to the CSV file on the SD memory card as decimal values along with the current date and time.

The saved location of CSV files is DATA0001\DATALOG\RESULT. The oldest data is saved at the top of the log data, and the latest data is saved at the bottom of the log data.

When the execution of the DLOG instruction is complete, the completion output M100 is turned on and the CMP instruction is executed once. The CMP instruction compares the status code stored in the execution status D100 with 0 and turns Q0 on or off. Q0 is turned on when an error occurs in the DLOG instruction.

While M0 is on, the log data is appended to the CSV file every 10 seconds.

Output results

| Time | D0000 | D0001 | D0002 | D0003 | D0004 | D0005 | D0010 |
|---------------------|-------|-------|-------|-------|-------|-------|---------------|
| 2012/02/06 10:20:30 | 12345 | 0 | 0 | 56789 | 0 | 0 | -3.402823E+38 |
| 2012/02/06 10:20:40 | 12345 | 0 | 0 | 56789 | 0 | 0 | -3.402823E+38 |
| 2012/02/06 10:20:50 | 12345 | 0 | 0 | 56789 | 0 | 0 | -3.402823E+38 |

TRACE (Data Trace)

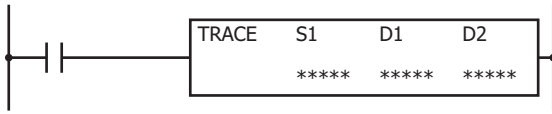

The TRACE instruction saves the values for the previous number of scans for the specified device in the specified data format as a CSV file on the SD memory card.

When the input is turned on, the date and time and the values of the previous scans for the specified device are output to the CSV file in the folder assigned by S1. When the execution of the instruction finishes, the device assigned by D1 is turned on and the execution status is stored to the device assigned by D2.

When the folder assigned by S1 does not exist on the SD memory card, that folder is created. The folder path is "DATA0001\TRACE\User specified folder." For details on the folder structure, see Chapter 5 "Special Functions" - "SD Memory Card" in the SmartAXIS Pro/Lite User's Manual.

The CSV file name is "DATE.csv." The date when the TRACE instruction is turned on is used as DATE.

Example: If the date is September 30, 2011, the file name is "20110930.csv".

When a CSV file with the same date does not exist in the folder designated by S1, the CSV file is created and the trace data is output. The oldest data is output at the top of the trace data, and the latest data is output at the bottom of the trace data.

Output example

| | | |
|---------------|---------------------|-----------------------|
| Triggered at: | 2012/02/06 08:30:23 | ← Header row 1 |
| Scan | D0010 | ← Header row 2 |
| Old | 12345 | ← Data 2 scans before |
| | 12345 | ← Data 1 scan before |
| New | 12345 | ← Latest data |

When a CSV file for the same date already exists in the folder designated by S1, the header and trace data are appended to the CSV file.

Output example

| | | |
|---------------|---------------------|--------------------------------|
| Triggered at: | 2012/02/06 08:30:23 | |
| Scan | D0010 | |
| Old | 12345 | |
| | 12345 | |
| New | 12345 | |
| | | |
| Triggered at: | 2012/02/06 17:16:15 | ← Appended header row 1 |
| Scan | D0010 | ← Appended header row 2 |
| Old | 1212 | ← Appended data 2 scans before |
| | 1212 | ← Appended data 1 scan before |
| New | 1212 | ← Appended latest data |

When the execution of the TRACE instruction finishes, the device designated by D1 is turned on and the status code is stored to the device designated by D2 according to the execution result. For status codes, see "3. D2 (destination 2): Execution status" on page 26-10.

Notes:

- The TRACE instruction accumulates data while SmartAXIS is running but does not accumulate data when SmartAXIS is stopped.
- Data is accumulated while SmartAXIS is running even when the input to the TRACE instruction is off.
- When the input to the TRACE instruction is turned on, the accumulated data is output to the CSV file.
- The time required to create a new CSV file (create a file and output header) is 870 μs.
- Trace data is accumulated even when the MCS (master control set) instruction is on.

Notes:

- The maximum number of TRACE instructions that can be programmed in a user program is three. Make sure that the folder name specified by the TRACE instruction is not duplicated by any of the folder names specified by the other TRACE instructions. When the folders are duplicated, trace data with a mixed format is output to the same CSV file.
- The number of scans of which the trace data can be saved to the CSV file when the TRACE instruction is executed one time depends on the number of devices specified to trace and the display type for each device. For details, see "9. Trace data size" on page 26-11.
- The TRACE instruction cannot be used in an interrupt program. If used, a user program execution error will result, turning on special internal relay M8004 and the ERR LED on the SmartAXIS. For details about the user program execution errors, see "User Program Execution Errors" on page 4-13.
- Trace data is not accumulated when the TRACE instruction is skipped by the JMP (jump) instruction. For the JMP (jump) instruction, see "JMP (Jump) and JEND (Jump End)" on page 5-29.
- While the input to the TRACE instruction is on, the trace data is repeatedly output to the CSV file. When you want to output the trace data only one time, add a SOTU (single output up instruction) or SOTD (single output down instruction) to the input conditions. For SOTU (single output up instruction) or SOTD (single output down instruction), see "Basic Instructions" - "SOTU and SOTD (Single Output Up and Down)" on page 5-26.
- The data writing process to the SD memory card for the TRACE instruction takes several scans. Once a TRACE instruction is executed, the process continues until the trace data transfer is complete, regardless of any change in the instruction input. While the trace data is being written to the SD memory card, the instruction is not executed even when the input to the TRACE instructions are turned on. To execute the TRACE instruction again, confirm that the previous data writing process has finished, and then execute the instruction.

Applicable SmartAXIS

| FT1A-12 | FT1A-24 | FT1A-40 | FT1A-48 | FT1A-Touch |
|---------|---------|---------|---------|------------|
| — | — | X | X | — |

Valid Devices

| Device | Function | I | Q | M | R | T | C | D | Constant | Repeat |
|--------------------|--------------------|---|---|---|---|---|---|---|----------|--------|
| S1 (Source 1) | Folder name (Note) | — | — | — | — | — | — | — | — | — |
| D1 (Destination 1) | Completion output | — | X | ▲ | — | — | — | — | — | — |
| D2 (Destination 2) | Execution status | — | — | — | — | — | — | ▲ | — | — |

Note: Specify the folder name by entering characters.

▲ Special internal relays cannot be designated as D1. Special data registers cannot be designated as D2.

Settings

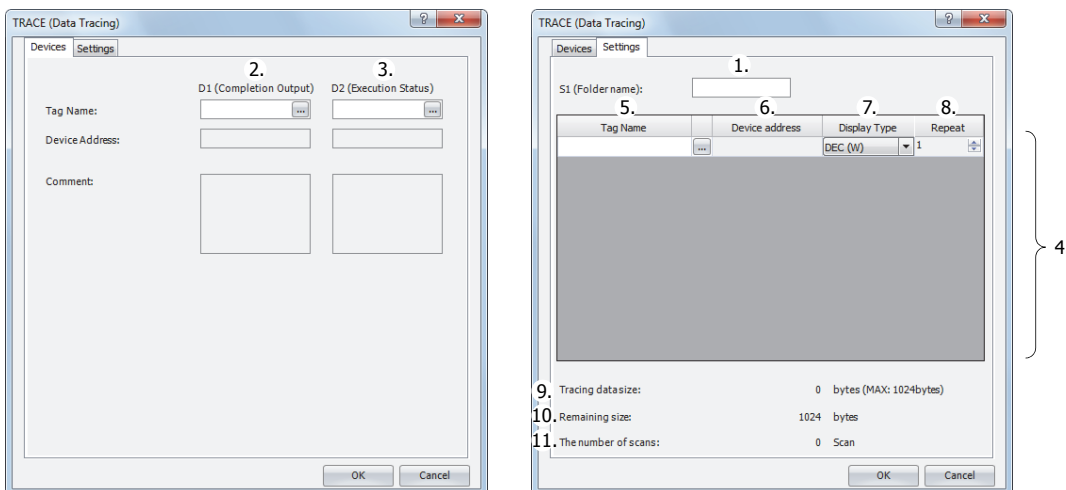

1. S1 (source 1): Folder name

Specify the folder name on the SD memory card that will store the trace data using up to 8 single-byte alphanumeric characters.

Notes:

- The following single-byte characters cannot be used in folder names:
/ \ : * ? " < > | # { } % & ~
- Consecutive periods cannot be used in folder names.
- A period cannot be used at the start or the end of the folder name.
- Single-byte spaces at the start or the end of the folder name are omitted.

26: DATA LOG INSTRUCTIONS

2. D1 (destination 1): Completion output

Specifies the device that turns on when the transfer of trace data to SD card and the execution of the TRACE instruction are complete. This device turns on regardless of the success or failure of the transfer of trace data to the SD memory card.

3. D2 (destination 2): Execution status

Specifies the data register to store the status code. One of the following status codes is stored according to the TRACE instruction execution status and result.

| Status code | Status | Description |
|-------------|---------------------------------|---|
| 0 | Normal | — |
| 1 | SD memory card insertion error | The SD memory card is not inserted |
| 2 | SD memory card capacity error | The SD memory card is full |
| 3 | SD memory card writing error | Writing trace data to the SD memory card fails |
| 4 | CSV file capacity error | The CSV file exceeds 5 MB |
| 5 | SD memory card protection error | The SD memory card is write protected |
| 6 | SD memory card access error | The TRACE instruction is executed while another DLOG instruction or TRACE instruction is being executed |
| 7 | Characters conversion error | Converting trace data to numeric characters fails |
| 8 | Folder creation error | Creating the folder fails |
| 9 | CSV file open error | Opening the CSV file fails |
| 32 | Executing TRACE instruction | Writing trace data to SD memory card fails |

4. Settings

The following is a list of the device and display types that can be set as the data to be output to the CSV files.

| Display type | Valid Devices |
|--------------|-------------------|
| DEC(W) | TC, TP, CC, CP, D |
| DEC(I) | D |
| DEC(D) | CC, CP, D |
| DEC(L) | D |
| DEC(F) | D |
| HEX(W) | TC, TP, CC, CP, D |
| HEX(D) | CC, CP, D |
| BIN(B) | I, Q, M, R, T, C |

5. Tag Name

Enter tag names or device addresses to specify the devices to the CSV files.

6. Device Address

When the devices are specified as tag names, the corresponding device addresses are shown.

7. Display Type

Select the display type from the following table for each device for when the device values are output to the CSV file.

| Display type | Range | Maximum characters |
|--------------|---------------------------------|--------------------|
| DEC(W) | 0 to 65,535 | 5 |
| DEC(I) | -32,768 to 32,767 | 6 |
| DEC(D) | 0 to 4,294,967,295 | 10 |
| DEC(L) | -2,147,483,648 to 2,147,483,647 | 11 |
| DEC(F) | -3.402823E+38 to 3.402823E+38 | 13 |
| HEX(W) | 0000 to FFFF | 4 |
| HEX(D) | 00000000 to FFFFFFFF | 8 |
| BIN(B) | 0 or 1 | 1 |

8. Repeat

The data in as many consecutive devices as the specified repeat, starting from the specified device address, are output to the SD memory card.

For example, when the display type of D10 is DEC(W) and the repeat is set to 8, the data is output to SD memory card as follows.

| | | | | | | | | | |
|---------------|-------------------|-------|-------|-------|-------|-------|-------|-------|-----------------------|
| Triggered at: | 2011/9/7 15:40:30 | | | | | | | | ← Header row 1 |
| Scan | D0010 | D0011 | D0012 | D0013 | D0014 | D0015 | D0016 | D0017 | ← Header row 2 |
| Old | 1 | 9 | 17 | 25 | 33 | 41 | 49 | 57 | ← Data 7 scans before |
| | 2 | 10 | 18 | 26 | 34 | 42 | 50 | 58 | ← Data 6 scans before |
| | 3 | 11 | 19 | 27 | 35 | 43 | 51 | 59 | ← Data 5 scans before |
| | 4 | 12 | 20 | 28 | 36 | 44 | 52 | 60 | ← Data 4 scans before |
| | 5 | 13 | 21 | 29 | 37 | 45 | 53 | 61 | ← Data 3 scans before |
| | 6 | 14 | 22 | 30 | 38 | 46 | 54 | 62 | ← Data 2 scans before |
| | 7 | 15 | 23 | 31 | 39 | 47 | 55 | 63 | ← Data 1 scan before |
| New | 8 | 16 | 24 | 32 | 40 | 48 | 56 | 64 | ← Latest data |

9. Trace data size

The amount of memory that the TRACE instruction uses for the current trace settings is shown. The amount of memory used increases when a device to trace the data is added. You can register up to a maximum of 64 devices (the total amount of memory must be less than or equal to 1,024 bytes). One byte of memory area is required for each character.

10. Remaining size

The amount of free memory (the difference between the trace data size and 1,024 bytes) is shown.

11. The number of scans

How many scans of trace data can be accumulated with the current trace settings is shown. The number of scans of data that can be accumulated depends on the format of the trace data to output. If there is little data to output per scan, the data for many scans can be accumulated.

CSV File Output Format and File Format Configuration

The CSV file output format is as follows. You can change the separating character for each data and the decimal symbol for floating point numbers that are output to the CSV files on the Function Area Settings dialog box.

• **Output format**

```

Triggered at:,2011/09/07 15:40:30
Scan,D0010,D0020,D0030,D0040,D0050,D0060,D0070,D0080
Old,1,9,17,25,33,41,49,57
,2,10,18,26,34,42,50,58
,3,11,19,27,35,43,51,59
,4,12,20,28,36,44,52,60
,5,13,21,29,37,45,53,61
,6,14,22,30,38,46,54,62
,7,15,23,31,39,47,55,63
New,8,16,24,32,40,48,56,64
:
:
:
    
```

When the TRACE instruction is executed and the CSV file for the same date does not exist in the folder designated by S1, a new CSV file is created and the trace data is output as shown in above output format example. When the date changes and the TRACE instruction is executed, a new CSV file is created with a new file name.

26: DATA LOG INSTRUCTIONS

File format configuration procedure

1. From the WindLDR menu bar, select **Configuration > Cartridges**.
2. Under **Data Log and Trace (CSV File Output)**, configure the separating character and the decimal symbol.
The separating characters and the decimal symbols that are contained in the CSV file vary by country and region. You can select the symbols to use from the following:
 - (1) Separating character: "," (comma) or ";" (semicolon)
 - (2) Decimal symbol: "." (period) or "," (comma)
3. Click the **OK** button to close the dialog box.

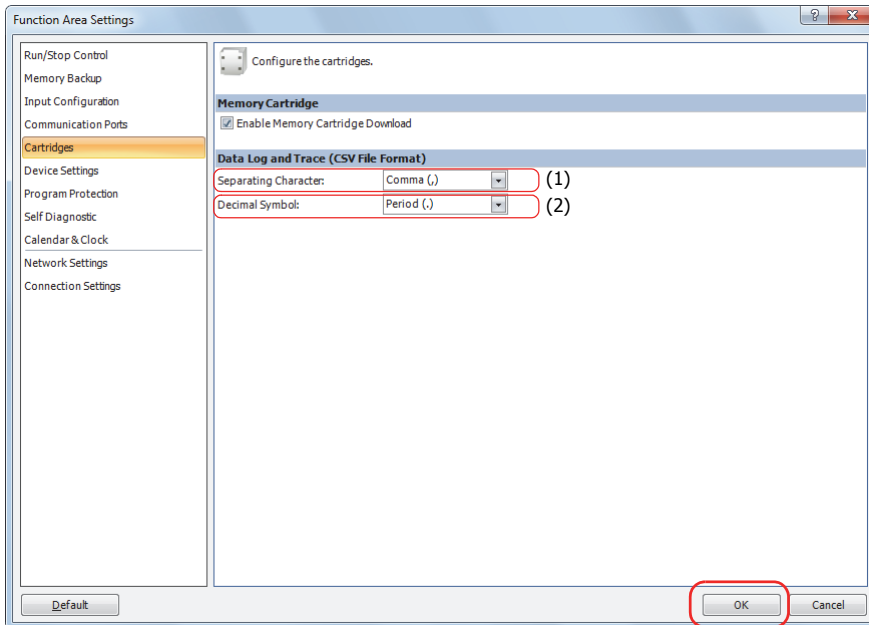

Examples: TRACE

When M0 is turned on, the accumulated data of D0 through D5 (data type W (word)) and D10 (data type F (floating point)) are saved as decimal values in a CSV file on the "RESULT" folder on the SD memory card.

Output sample

| | | | | | | | |
|---------------|---------------------|-------|-------|-------|-------|-------|---------------|
| Triggered at: | 2012/02/06 10:20:30 | | | | | | |
| Scan | D0000 | D0001 | D0002 | D0003 | D0004 | D0005 | D0010 |
| Old | 12345 | 2 | 12345 | 56789 | 1 | 56789 | -3.402823E+38 |
| | 12345 | 2 | 12347 | 56789 | 1 | 56788 | -3.402823E+38 |
| | 12345 | 2 | 12349 | 56789 | 1 | 56787 | -3.402823E+38 |
| | : | : | : | : | : | : | : |
| | 12345 | 2 | 12379 | 56789 | 1 | 56772 | -3.402823E+38 |
| | 12345 | 2 | 12381 | 56789 | 1 | 56771 | -3.402823E+38 |
| New | 12345 | 2 | 12383 | 56789 | 1 | 56770 | -3.402823E+38 |

The sample user program described below operates as follows.

- M100 is turned on when the writing trace data to the SD memory card completes.
- The TRACE instruction status code is stored to D100.
- The execution status saved in D100 is checked and Q0 is turned on if an error occurs.

• Configuration Procedure

1. Insert the instructions in the Ladder editor.

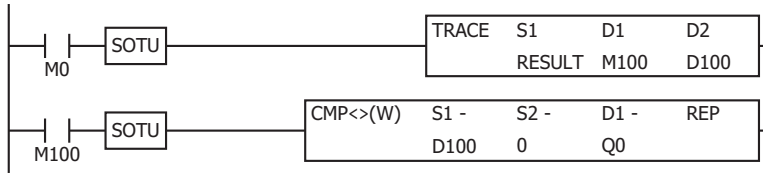

2. Configure the TRACE instruction.

Configure the Devices tab.

- (1) Designate M100 as D1 (Completion Output).
- (2) Designate D100 as D2 (Execution Status).

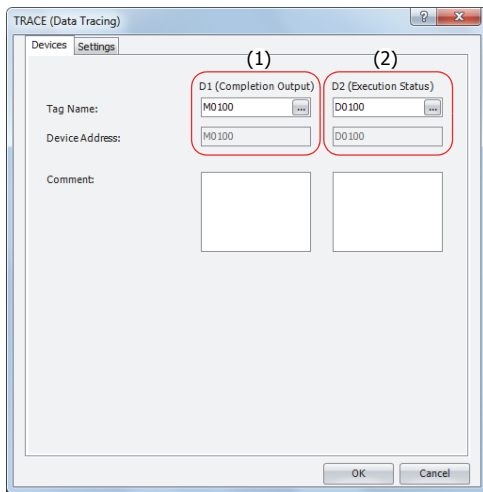

Configure the Settings tab.

- (3) Enter "RESULT" in S1 (Folder Name).
- (4) Configure D0 to output the decimal value of D0 to the CSV files with the data type W (word).
- (5) Set the repeat to 6 to output the values of D0 through D5 to the CSV files.
- (6) Configure D10 to output the value of D10 to the CSV files with the data type F (float).

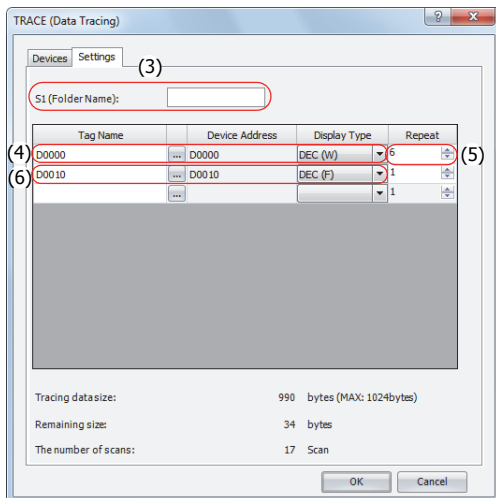

The configuration is now completed.

26: DATA LOG INSTRUCTIONS

• Operation Description

When M0 is turned on, the TRACE instruction is executed one time. When the TRACE instruction is executed, the data of D0 through D5 and D10 in the previous 17 scans is output to a CSV file on the SD memory card as decimal values along with the date and time of the execution.

The saved location of CSV files is DATA0001\TRACE\RESULT. The oldest data is saved at the top of the trace data, and the latest data is saved at the bottom of the trace data.

When the execution of the TRACE instruction completes, the completion output M100 is turned on and the CMP instruction is executed once. The CMP instruction compares the status code stored in the execution status D100 with 0 and turns Q0 on or off. Q0 is turned on when an error occurs in the TRACE instruction.

Output results

| | | | | | | | |
|---------------|---------------------|-------|-------|-------|-------|-------|---------------|
| Triggered at: | 2012/02/06 10:20:30 | | | | | | |
| Scan | D0000 | D0001 | D0002 | D0003 | D0004 | D0005 | D0010 |
| Old | 12345 | 2 | 12345 | 56789 | 1 | 56789 | -3.402823E+38 |
| | 12345 | 2 | 12347 | 56789 | 1 | 56788 | -3.402823E+38 |
| | 12345 | 2 | 12349 | 56789 | 1 | 56787 | -3.402823E+38 |
| | 12345 | 2 | 12351 | 56789 | 1 | 56786 | -3.402823E+38 |
| | 12345 | 2 | 12353 | 56789 | 1 | 56785 | -3.402823E+38 |
| | 12345 | 2 | 12355 | 56789 | 1 | 56784 | -3.402823E+38 |
| | 12345 | 2 | 12357 | 56789 | 1 | 56783 | -3.402823E+38 |
| | 12345 | 2 | 12359 | 56789 | 1 | 56782 | -3.402823E+38 |
| | 12345 | 2 | 12361 | 56789 | 1 | 56781 | -3.402823E+38 |
| | 12345 | 2 | 12363 | 56789 | 1 | 56780 | -3.402823E+38 |
| | 12345 | 2 | 12365 | 56789 | 1 | 56779 | -3.402823E+38 |
| | 12345 | 2 | 12367 | 56789 | 1 | 56778 | -3.402823E+38 |
| | 12345 | 2 | 12369 | 56789 | 1 | 56777 | -3.402823E+38 |
| | 12345 | 2 | 12371 | 56789 | 1 | 56776 | -3.402823E+38 |
| | 12345 | 2 | 12373 | 56789 | 1 | 56775 | -3.402823E+38 |
| | 12345 | 2 | 12375 | 56789 | 1 | 56774 | -3.402823E+38 |
| New | 12345 | 2 | 12377 | 56789 | 1 | 56773 | -3.402823E+38 |

27:SCRIPT

Introduction

The SCRPT instruction calls and executes a script from the ladder program.

SCRPT (Script)

Executes the specified script.

Symbol

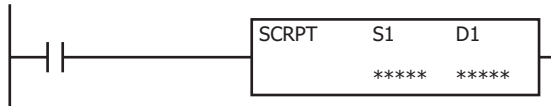

Operation

When the input turns on, the script that corresponds to the script ID specified by S1 is executed. When the script is finished executing, the execution status and the execution time are stored in D1 and D1+1. To use the SCRPT instruction, you must create a script to execute in Script Manager dialog box beforehand.

For details about the script executed by SCRPT instruction, refer to the following manuals:

[Script function overview]

- For the SmartAXIS Pro/Lite, see Chapter 13 "Scripts" - "Script Function Overview" in the SmartAXIS Pro/Lite User's Manual.
- For the SmartAXIS Touch, see Chapter 20 "Script" - "1.1 Overview of the Script Function" in the SmartAXIS Touch User's Manual.

[Script editing]

- For the SmartAXIS Pro/Lite, see Chapter 13 "Scripts" - "Script Editing and Management" in the SmartAXIS Pro/Lite User's Manual.
- For the SmartAXIS Touch, see Chapter 20 "Script" - "2. Editing and Management of the Script" in the SmartAXIS Touch User's Manual.

Applicable SmartAXIS

| FT1A-12 | FT1A-24 | FT1A-40 | FT1A-48 | FT1A-Touch |
|---------|---------|---------|---------|------------|
| X | X | X | X | X |

Valid Devices

| Device | Function | I | Q | M | R | T | C | D | Constant | Repeat |
|--------------------|-------------------|---|---|---|---|---|---|----------|----------|--------|
| S1 (Source 1) | Script ID | — | — | — | — | — | — | X | 1-255 | — |
| D1 (Destination 1) | Execution results | — | — | — | — | — | — | X (Note) | — | — |

Note: Special data registers cannot be specified.

Settings

S1 (source 1): Script ID

Specify the script ID. A constant or data register can be specified.

D1 (destination 1): Execution results

Specify the data register where the execution results are stored. Two data registers starting with the specified data register are used. The script execution status (error code at script completion) is stored in D1. The execution time from when the script execution is started until it is completed is stored in D1+1 in 100 μs increments.

27: SCRIPT

Execution results

The execution results (D1, D1+1) store the execution status and the execution time.

Execution status

| Numeric value | Status | Error cause |
|---------------|---------------------|--|
| 0 | Normal termination | — |
| 1 | Arithmetic error | Division by zero, floating point format error |
| 2 | Script ID error | The specified script does not exist |
| 3 | Device access error | Invalid device specified, device boundary exceeded |

If any error occurs other than the script ID error, script processing is canceled and the execution of the SCRPT instruction is terminated. If the script ID error occurs, D1 and D1+1 are updated and execution of the SCRPT instruction terminates.

Execution time

The execution time from when the execution of the specified script is started until it is completed is stored in 100 μ s increments. For example, when it takes 1.45 ms to execute the specified script, 15 is stored as the execution time. When it takes 6553.5 ms or longer to execute the specified script, 65535 is stored as the execution time. The SCRPT instruction execution time is affected by interrupt processing or other processing that occurs during the execution.

If any error occurs other than the script ID error, the script execution time from when the script execution is started until the error occurs is stored as the execution time. If the script ID error occurs, zero is stored as the execution time.

Script selection

To specify a registered script ID for S1 in WindLDR, click **Refer** button on the SCRPT instruction dialog box to open Script Manager dialog box. Choose the script ID to execute and click on **Select** button on Script Manager dialog box. The selected ID will be entered to S1.

28: PID INSTRUCTION

Introduction

The PID instruction performs auto tuning and PID control for temperature control and other purposes.

PID (PID Instruction)

The PID instruction executes PID control and outputs the result. When auto tuning is performed, the optimal PID parameters are calculated.

Symbol

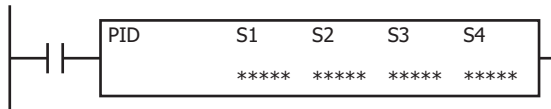

Operation

The PID instruction is used to perform temperature and other types of control. When the input is on, auto tuning and PID control are performed.



Warning

- Special technical knowledge about the PID control is required to use the PID function of the SmartAXIS Touch. Use of the PID function without understanding the PID control may cause the SmartAXIS Touch to perform unexpected operation, resulting in disorder of the control system, damage, or accidents.
- When using the PID instruction for feedback control, emergency stop and interlocking circuits must be configured outside the SmartAXIS Touch. If such a circuit is configured inside the SmartAXIS Touch, failure of inputting the process variable may cause equipment damage or accidents.

Note: The maximum number of PID instructions that can be programmed in a user program is six. For details about each control, see "PID Control" on page 28-14.

Applicable SmartAXIS

| FT1A-12 | FT1A-24 | FT1A-40 | FT1A-48 | FT1A-Touch |
|---------|---------|---------|---------|------------|
| — | — | — | — | X |

Note: PID instruction can be used with FT1A-*14KA-* and FT1A-*14SA-* only.

Valid Devices

| Device | Function | I | Q | M | R | T | C | D | Constant | Repeat |
|---------------|----------------------|---|---|---|---|---|---|---|----------|--------|
| S1 (Source 1) | Control registers | — | — | — | — | — | — | ▲ | — | — |
| S2 (Source 2) | Initialization input | X | — | X | — | — | — | — | — | — |
| S3 (Source 3) | Control relays | — | — | ▲ | — | — | — | — | — | — |
| S4 (Source 4) | Set point | — | — | — | — | — | — | ▲ | — | — |

▲ Special data registers cannot be designated as S1 and S4. Special internal relays cannot be designated as S3.

Settings

The PID instruction dialog box has 4 tabs: **Devices**, **Input**, **Control**, and **Output** tab.

The **Devices** tab configures the devices used with the PID instruction. The **Input**, **Control**, and **Output** tabs configure the initial values of the parameters for the PID instruction.

■ **Devices tab**

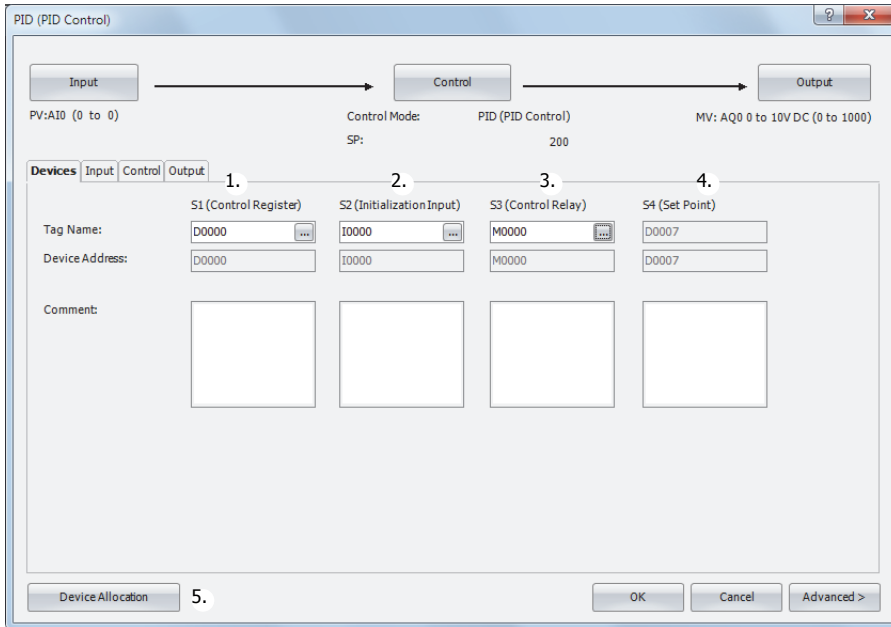

| Settings | Content |
|----------------|--|
| Tag Name | Specifies the tag name for the device or the device address |
| Device Address | Shows the device address that corresponds to the tag name. |
| Comment | Shows the comment for the device address. This item can be edited. |

1. S1 (source 1): Control Register

Specify the device to store the PID instruction parameters. A data register can be specified. 40 words are used starting from the specified data register.

For allocating the data registers, see "5. Device Allocation" on page 28-3.

The data registers are initialized with the values configured on the input tab, control tab, and output tab by turning on the initialization input. For initialization, see "2. S2 (source 2): Initialization Input" on page 28-2.

2. S2 (source 2): Initialization Input

Specify the device to initialize the control registers. You can specify either an input or an internal relay.

The values configured on the input tab, control tab, and output tab are stored in the control registers and control relays when the initialization input turns on.

For tag names, device addresses, and comments, see "1. S1 (source 1): Control Register" on page 28-2.

3. S3 (source 3): Control Relay

These relays perform control of PID control and output the control results of the PID instruction. You can specify an internal relay. 16 bits are used starting from the specified device. The role of each bit is different. You can switch between auto and manual mode for the PID instruction and execute auto tuning by turning the bits on and off. The PID instruction control result and process variable error are also output as alarms.

For tag names, device addresses, and comments, see "1. S1 (source 1): Control Register" on page 28-2.

4. S4 (source 4): Set Point

Shows the device that stores the PID control set point. When a data register is specified in S1 (source 1), S1+7 is automatically allocated.

For tag names, device addresses, and comments, see "1. S1 (source 1): Control Register" on page 28-2.

5. Device Allocation

Click this button to display the Device Allocation dialog box. As shown below, a table containing the data registers and internal relays and corresponding PID instruction settings is displayed in the dialog box (6). Click **Allocate Comments** button (7) and you can allocate the names of settings as comments for the data registers and internal relays.

Device Allocation dialog box

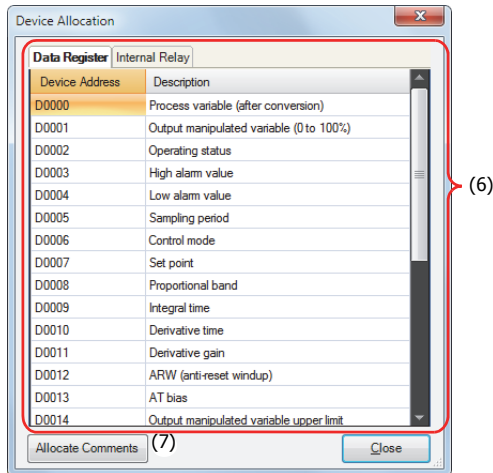

Input tab

This tab configures the input parameters for the PID instruction.

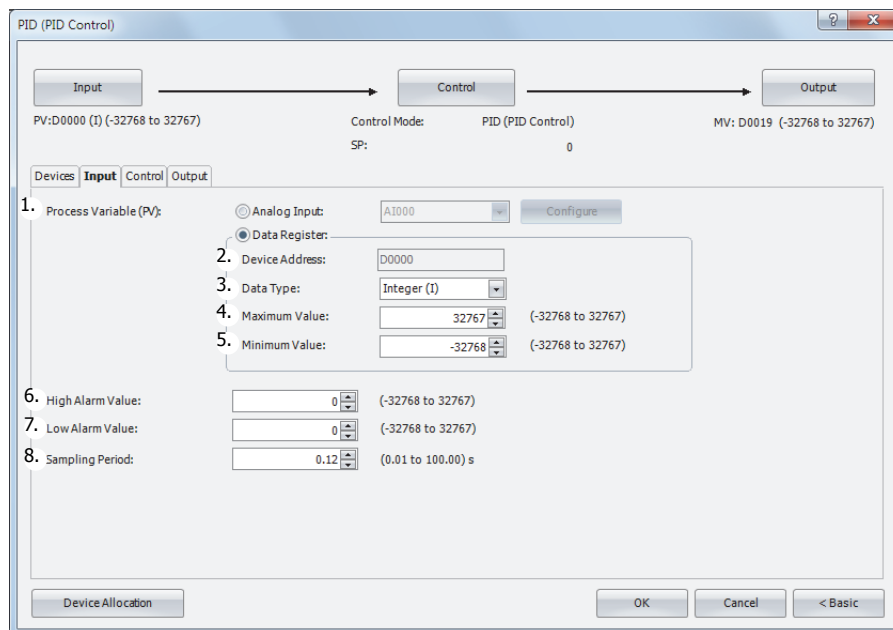

1. Process Variable (S1+0)

Configure the input for the PID control. The process variable is linearly converted and given to the PID control for the input value. The value can be specified as **Analog Input** or **Data Register**.

When Analog Input is specified

AI0 to AI5 can be specified. The value stored in the special data register that corresponds to the specified analog input (AI0 to AI5) is used as the PID control input. The analog input value is also stored in control register S1+0. S1+0 is read-only. For the allocation of special data registers, see Chapter 27 "Internal Devices" - "2.2 Control Device Addresses" in the SmartAXIS Touch User's Manual.

Notes:

- To use an analog input (AI0 to AI5), the analog input must be configured in advance. For details on analog input settings, see Chapter 3 "Project" - "4.12 Analog Input" in the SmartAXIS Touch User's Manual.
- When **Analog Input** is specified, the minimum value and the maximum value of the analog input settings are used as the minimum value and the maximum value for the input.

When Data Register is specified

The value stored in S1+0 of the control registers is used as the PID control input. Store a value in S1+0 that satisfies the condition: minimum value (5) \leq process variable \leq maximum value (4).

28: PID INSTRUCTION

Configure parameters 2 through 5 when data register is selected as the process variable.

2. Device Address

Shows the start data register (S1+0) of the control registers configured on the device tab when **Data Register** is specified as the process variable (1).

3. Data Type

Select the process variable (S1+0) processing unit. Either W (word) or I (integer) can be selected.

4. Maximum Value, 5. Minimum Value

When Data Register is specified as the Process Variable (1), configure the range of input settings (process variable, high alarm value, low alarm value) and control settings (set point, AT bias) in PID control with the maximum and minimum values. The maximum value and minimum value can be configured within the range of the data type (3).

- When the data type is I (integer): -32,768 to +32,767.
- When the data type is W (word): 0 to 65,535

6. High Alarm Value (S1+3)

Set the upper limit value of the process variable.

If the process variable is higher than or equal to the high alarm value, the high alarm output (S1+3) turns on. If the process variable is lower than the high alarm value, the high alarm output (S1+3) turns off.

The high alarm value can be set in the range between the low alarm value and the maximum input value.

7. Low Alarm Value (S1+4)

Set the lower limit value of the process variable.

If the process variable is lower than or equal to the low alarm value, the low alarm output (S1+4) turns on. If the process variable is higher than the low alarm value, the low alarm output (S1+4) turns off.

The low alarm value can be set in the range between the minimum input value and the high alarm value.

8. Sampling Period (S1+5)

Set the cycle to execute the PID instruction. If the sampling period is set to a value shorter than the scan time, the PID instruction is executed at each scan. If the sampling period is set to a value longer than the scan time, the interval between the executions of PID instruction exceeds the sampling period. Exceeded period of time is deducted from the next sampling period.

The sampling period can be set from 0.01 to 100.00 seconds in 0.01 second increments.

Sampling period ≤ Scan time

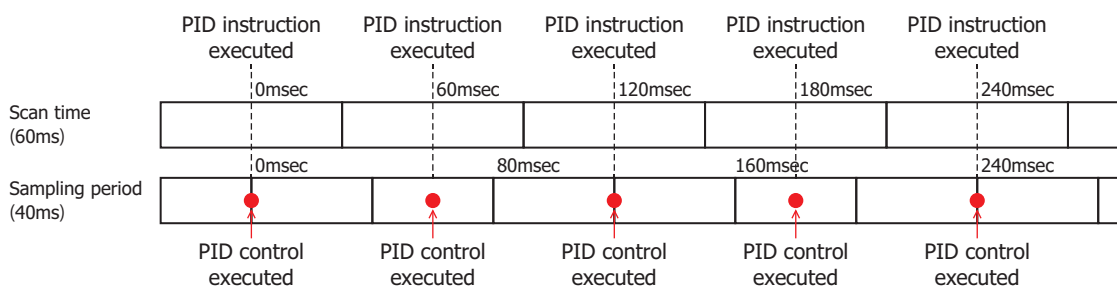

Sampling period: 80 ms, scan time: 60 mc (sampling period > scan time)

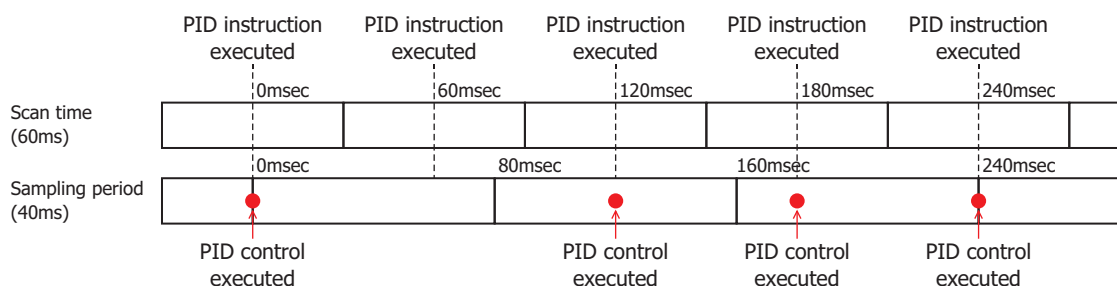

The PID instruction is not executed at each scan. The PID instruction is executed at the scan immediately after the sampling time has elapsed.

■ **Control tab**

This tab configures the control parameters for the PID instruction.

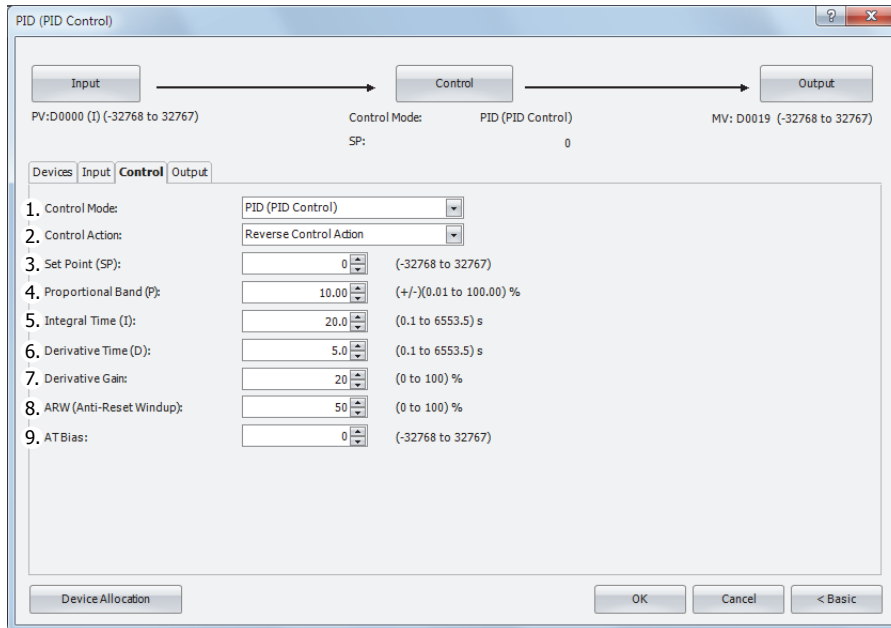

1. Control Mode (S1+6)

Select **PID (PID Control)**, **P (Proportional Control)**, **PI (PI Control)** or **PD (PD Control)** according to the characteristics of the target application.

For details about each control, see "PID Control" on page 28-14.

2. Control Action (S3+0)

Select the control action from **Direct Control Action** or **Reverse Control Action**.

Direct control action operates to increase the output manipulated variable when the process variable is higher than the set point. Cooling equipment uses this operation. Reverse control action operates to increase the output manipulated variable when the process variable is lower than the set point. Heating furnaces uses this operation. (S3+0) is read-only.

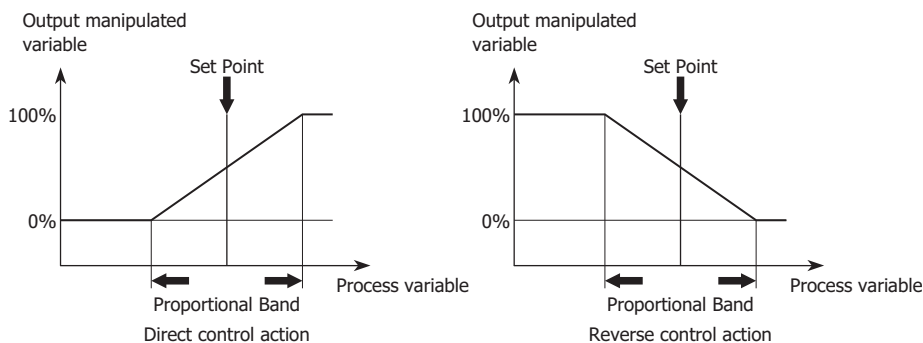

3. Set Point (S1+7)

The set point can be set between the minimum value and the maximum value of the process variable.

4. Proportional Band (S1+8)

The proportional action changes the output proportional to the deviation between the set point and process variable.

If the process variable is in the range of the proportional band, the control output (S3+6) turns on or in proportional to the deviation. If the process variable is out of the proportional band, the control output (S3+6) is always on or off.

When the proportional band is made larger, the control output (S3+6) turns on and off from a state where the deviation is large, so overshooting (process variable goes above the set point), undershooting (process variable falls below the set point), and hunting (process variable is in an unstable undulating state) decrease, but it takes time until the process variable reaches the set point and the offset between the set point and the process variable becomes larger.

When the proportional band is made smaller, the control output starts turning on and off at near the set point, so the time until the process variable reaches the set point decreases and the offset also becomes smaller, but hunting increases. If the proportional band is set extremely small, the control is the same as on/off operation.

When auto tuning (AT) is used, the appropriate proportional band can be automatically set for the target application. For details, see "Auto Tuning (AT)" on page 28-15.

The proportional band can be set from ± 0.01 to $\pm 100.00\%$ in 0.01% increments.

5. Integral Time (S1+9)

With only the proportional action, an offset occurs between the set point and the process variable even when the target application is in a stable state. In order to bring this offset close to 0, the integral action is required. Integral time is a factor that determines the manipulated variable by the integral action. If the integral time is too short, the integral action becomes too large, which causes hunting of a long cycle. Conversely, if the integral time is too long, the processing until the set point is reached will take time. The integral execution range is - proportional band to + proportional band. If the process variable goes out of the proportional band due to a change in the set point or a disturbance, the integration calculation stops. As a result, the response of the output manipulated variable against the change in set point improves and undershoot and overshoot can be reduced.

When auto tuning is used, the appropriate integral time can be automatically set for the target application. For details, see "Auto Tuning (AT)" on page 28-15.

The integral time can be set from 0.1 to 6553.5 seconds in 0.1 second increments.

6. Derivative Time (S1+10)

When the set point changes or when the difference between the set point and the process variable increases due to a disturbance, the derivative action quickly brings the process variable close to the set point by increasing the manipulated variable. When the derivative time is decreased, the derivative action becomes weaker and the response to rapid temperature changes becomes slower. The action to control rapid temperature increases also becomes weaker, so the time to reach the set point will become shorter, but overshoot will occur more easily. When the derivative time is increased, the derivative action becomes large and the response to rapid temperature changes becomes faster. The action to control rapid temperature increases also becomes more powerful, so the time to reach the set point will become longer, but overshoot will occur less easily. When auto tuning is used, the appropriate derivative time can be automatically set for the target application. For details, see "Auto Tuning (AT)" on page 28-15.

The derivative time can be set from 0.1 to 6553.5 seconds in 0.1 second increments.

7. Derivative Gain (S1+11)

When the derivative gain is set to a small value, the output manipulated variable is more easily affected by noise and changes in the set point. When the derivative gain is set to a large value, the output manipulated variable is less easily affected by noise and changes in the set point, but stability at normal times decreases. When noise or changes in the process variable occur, normally set this to 20 to 30%.

The derivative gain can be set from 0 to 100% in 1% increments.

8. ARW (Anti Reset Windup) (S1+12)

Set the point to start the integral action. If the integral term is enabled from the start of execution of the PID instruction, overshoot may be caused. Overshoot can be controlled by delaying the integral action with ARW linked to the proportional band. ARW is normally 100%, which results in appropriate control with little overshoot. If ARW is set too small, overshoot can be eliminated, but an offset may occur.

The ARW can be set from 0 to 100%.

For example, when ARW=50% and proportional band=20.00%, the integral action starts from when the deviation becomes smaller than 10%.

9. AT (Auto Tuning) Bias (S1+13)

Set the bias value for the auto tuning.

The auto tuning start point is determined by the AT bias value in 1 increments.

When process variable \leq (set point - AT bias value):

AT start point = (set point - AT bias value)

When process variable \geq (set point + AT bias value):

AT start point = (set point + AT bias value)

When (set point - AT bias value) < process variable < (set point + AT bias value):

AT start point = set point

For details, see "Auto Tuning (AT)" on page 28-15.

The AT bias can be set between the minimum value and the maximum value of the process variable.

Output tab

This tab configures the output parameters for the PID instruction.

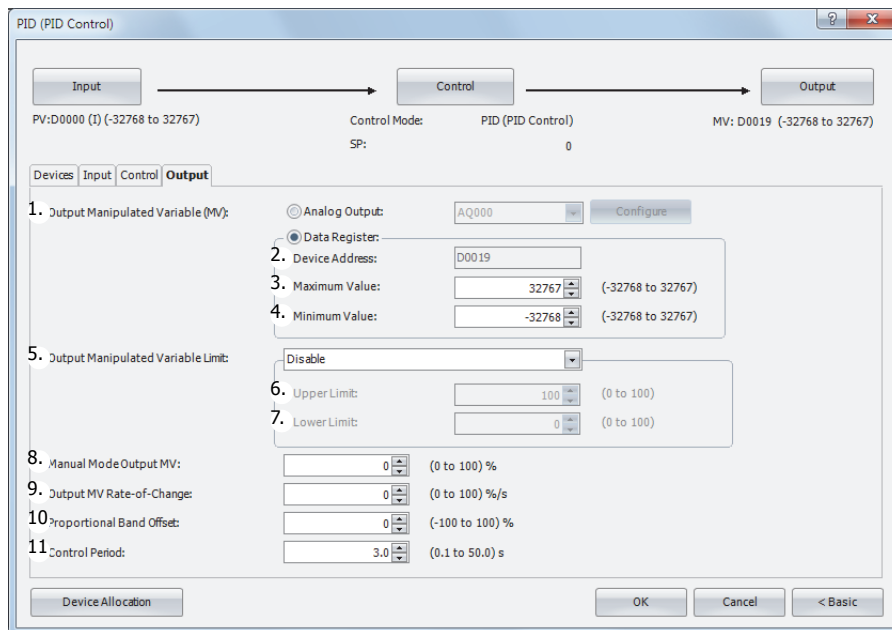

1. Output Manipulated Variable (analog value) (S1+19)

Set the output for the PID control. The value can be specified as **Analog Output** or **Data Register**. The manipulated variable calculated with the PID instruction according to the output manipulated variable limit (5) setting is stored.

When Analog Output is specified

An analog output (AQ0 to AQ5) can be set. The output is output from the set analog output (AQ0 to AQ5). For auto mode, the value that is output is the value stored in the output manipulated variable (analog value) (S1+19) having undergone linear conversion in the range of the maximum value and the minimum value of the analog output (AQ0 to AQ5). For manual mode, the value that is output is the value stored in the manual mode output manipulated variable (S1+17) having undergone linear conversion in the range of the maximum value and the minimum value of the analog output (AQ0 to AQ5).

The value of the output manipulated variable is automatically stored in the special data register that corresponds to the analog output (AQ0 to AQ5) For the allocation of special data registers, see Chapter 27 "Internal Devices" - "2.2 Control Device Addresses" in the SmartAXIS Touch User's Manual.

Note: To use an analog output (AQ0 to AQ5), the analog output must be configured in advance. For details on analog output settings, see Chapter 3 "Project" - "4.14 Analog Output" in the SmartAXIS Touch User's Manual

When Data Register is specified

The output manipulated variable for PID control is stored in control register S1+19 in the range of minimum value (4) \leq output manipulated variable \leq maximum value (3). For manual mode, the stored value is that the one, stored in the manual mode output manipulated variable (S1+17), is converted linearly in the range of minimum value (4) and maximum value (3).

Configure parameters 2 through 4 when data register is selected as the output manipulated variable.

2. Device address

Shows the control register (S1+19) configured on the device tab when **Data Register** is specified as the output manipulated variable (1).

3. Maximum Value, 4. Minimum Value

A value that is the PID instruction output manipulated variable having undergone linear conversion in the range of maximum value (3) and minimum value (4) is stored in the set data register.

5. Output Manipulated Variable Limit

Set the output manipulated variable by restricting the manipulated variable calculated by the PID instruction.

When Disabled

The manipulated variable calculated by the PID instruction is the output manipulated variable.

When Enable (upper and lower limits)

When the manipulated variable calculated by the PID instruction exceeds the output manipulated variable upper limit or lower limit, the upper limit value or the lower limit value is set as the output manipulated variable.

When Enable (percentage)

The result of the manipulated variable calculated by the PID instruction multiplied by 1 to 99% is set as the output manipulated variable. The output manipulated variable lower limit (7) is disabled at this time.

6. Output manipulated variable upper limit/percentage (S1+14)

When Output manipulated variable restriction is Output manipulated variable (upper limit, lower limit)

Set the upper limit value of the output manipulated variable for the control output. When the manipulated variable calculated by the PID instruction is higher than or equal to the output manipulated variable upper limit value, the set upper limit value is set as the output manipulated variable for the control output. When setting the output manipulated variable upper limit value, you must set the output manipulated variable upper limit value so that it satisfies output manipulated variable lower limit value < output manipulated variable upper limit value.

The output manipulated variable upper limit value can be set from 0 to 100% in 1% increments.

When Enable (percentage)

The result of the manipulated variable calculated by the PID instruction multiplied by 1 to 99% is set as the output manipulated variable.

Output manipulated variable = manipulated variable calculated by the PID instruction x output manipulated variable (scaling factor)

7. Output manipulated variable lower limit (S1+15)

When Enable (upper and lower limits)

Set the lower limit value of the output manipulated variable for the control output. When the manipulated variable calculated by the PID instruction is lower than or equal to the output manipulated variable lower limit value, the set lower limit value is set as the output manipulated variable for the control output. When setting the output manipulated variable lower limit value, you must set the output manipulated variable lower limit value so that it satisfies output manipulated variable lower limit value < output manipulated variable upper limit value. The output manipulated variable lower limit value can be set from 0 to 100% in 1% increments.

When Enable (percentage)

The output manipulated variable lower limit is disabled.

8. Manual Mode Output MV (S1+17)

Set the output manipulated variable for manual mode. To enable this function, Auto/manual mode (S3+1) must be turned on. The manual mode output manipulated variable is enabled for the output manipulated variable, the output manipulated variable (digital value), and the control output.

For switching between auto/manual mode, see "Auto/manual mode (S3+1)" on page 28-12.

The manual mode output manipulated variable can be set from 0.00 to 100.00% in 0.01% increments. When the output manipulated variable limit is **Output manipulated variable (upper limit, lower limit)**, the manual mode output manipulated variable must be set between output manipulated variable lower limit value and output manipulated variable upper limit value.

9. Output MV Rate-of-Change (S1+16)

Set the output manipulated variable to change in a second. When the output manipulated variable rate of change is 0%/second, this function is disabled.

When the difference between the set point and process variable is large, the normal output switches from off to on as shown in the diagram on the next page, but by setting the output manipulated variable rate of change, the rate of change for the output manipulated variable can be changed as shown in the diagram on the next page.

The output manipulated variable rate of change can be set from 0 to 100%/second in 1% increments.

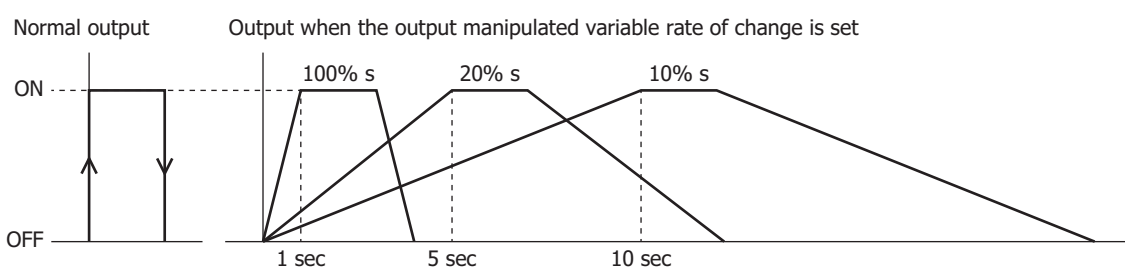

This function is suitable for the control of high-temperature heaters (elements composed of molybdenum, tungsten, platinum, used at approximately 1500 to 1800°C) that burn out when rapidly energized.

10. Proportional Band Offset (S1+20)

The proportional band can be shifted by the value set as the proportional band offset.

For example, if the proportional band offset is set to 20%, the proportional band shifted up by 20%.

The proportional band offset can be set from -100 to 100%.

11. Control Period (S1+21)

Set the cycle to perform on/off control of the control output according to the output manipulated variable. The on pulse width for the control period varies according to the output manipulated variable.

The control period can be set from 0.1 to 50.0 seconds in 0.1 second increments.

When control period: 50 (5 seconds)

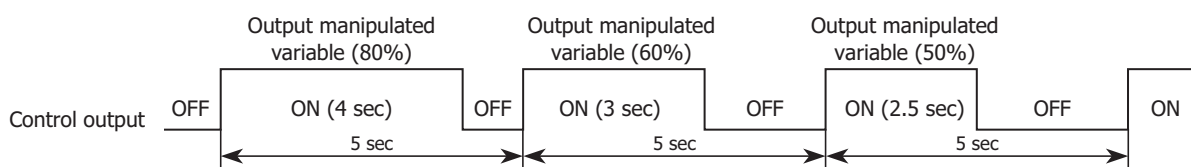

S1: Control registers

| Storage destination | Function | Setting details | R/W |
|---------------------|-----------------------------|--|-----|
| S1+0 | Process variable | <ul style="list-style-type: none"> When Analog Input is specified AI0 to AI5 can be selected. S1+0 is read-only. When Data Register is specified Store a value that satisfies process variable minimum value ≤ process variable ≤ process variable maximum value. S1+0 is readable/writable. | R/W |
| S1+1 | Output manipulated variable | Store a value between 0 and 100 (0% to 100%). | R |
| S1+2 | Operation status | Store the PID instruction execution status or error status. For details, see "Operation status (S1+2)" on page 28-10. | R |
| S1+3 | High alarm value | Set a value that satisfies low alarm value < high alarm value ≤ process variable maximum. | R/W |
| S1+4 | Low alarm value | Set a value that satisfies process variable minimum value ≤ low alarm value < high alarm value. | R/W |
| S1+5 | Sampling period | Set a value between 1 and 10,000 (0.01 to 100.00 seconds). Sampling period of 0 operates as 0.01 seconds and 10,001 or higher operates as 100.00 seconds. | R/W |
| S1+6 | Control mode | Select the control mode. 0: PID control 1: Proportional control 2: PI control 3: PD control | R/W |
| S1+7 | Set point | Set a value that satisfies process variable minimum value ≤ set point ≤ process variable maximum value. | R/W |
| S1+8 | Proportional band | Set a value between 1 and 10,000 (±0.01 to ±100.00%) Proportional band of 0 operates as ±0.01% and 10,001 or higher operates as ±100.00%. | R/W |
| S1+9 | Integral time | Set a value between 1 and 65,535 (0.1 to 6553.5 seconds). When integral time is 0, integral time is disabled. | R/W |
| S1+10 | Derivative time | Set a value between 1 and 65,535 (0.1 to 6553.5 seconds). When derivative time is 0, derivative time is disabled. | R/W |

28: PID INSTRUCTION

| Storage destination | Function | Setting details | R/W |
|-----------------------|--|---|-----|
| S1+11 | Derivative gain | Set a value between 0 and 100 (0 to 100%) Derivative gain of 0 operates as 0% and 101 or higher operates as 100%. | R/W |
| S1+12 | ARW | Set a value between 0 and 100 (0 to 100%) ARW of 101 or higher operates as 100%. | R/W |
| S1+13 | AT bias | Set a value that satisfies process variable minimum value \leq AT bias \leq process variable maximum value | R/W |
| S1+14 | Output manipulated variable upper limit | <ul style="list-style-type: none"> When Enable (upper and lower limits) Set a value between 0 and 100 (0 to 100%) Operates as 100 for a value other than 0 to 100. When Enable (percentage) Set a value between 1 and 99 (1 to 99%) Operates as 100 for a value other than 1 to 100. Output manipulated variable = manipulated variable calculated by the PID instruction x scaling factor | R/W |
| S1+15 | Output manipulated variable lower limit | Set a value between 0 and 100 (0 to 100%) Operates as 0 for a value other than 0 to 100. | R/W |
| S1+16 | Output manipulated variable rate of change | Set a value between 0 and 100 (0 to 100%/second) Operates as 100 for a value other than 0 to 100. | R/W |
| S1+17 | Manual mode output manipulated variable | Set a value between 0 and 10000 (0.00 to 100.00%). Set a value that satisfies output manipulated variable lower limit value \leq manual mode output manipulated variable \leq output manipulated variable upper limit value. Operates as the output manipulated variable lower limit value for a value other than output manipulated variable lower limit value to output manipulated variable. | R/W |
| S1+18 | Output manipulated variable (% value) | Output manipulated variable is stored as a value between -32,768 and +32,767 (-327.68 to +327.67%). For details, see "Output manipulated variable (% value) (S1+18)" on page 28-11. | R |
| S1+19 | Output manipulated variable (Analog value) | <ul style="list-style-type: none"> When Analog Output is specified for the output manipulated variable The output manipulated variable (%) stored in S1+1 is linearly converted with the minimum and maximum values configured for AQ0 to AQ5, and the converted value is stored in S1+19. When Data Register is specified for the output manipulated variable The output manipulated variable (%) stored in S1+1 is linearly converted with the minimum and maximum output values, and the converted value is stored in S1+19. | R |
| S1+20 | Proportional band offset | Set a value between -100 and 100 (-100 to 100%) Proportional band offset of -101 or lower operates as -100% and 101 or higher operates as 100%. | R/W |
| S1+21 | Control period | Set a value between 1 and 500 (0.1 to 50.0 seconds) Control period of 0 operates as 0.1 seconds and 501 or higher operates as 50.0 seconds. | R/W |
| S1+22 to S1+39 | — Reserved — | — | — |

Other control registers

Output manipulated variable (S1+1)

Shows the output manipulated variable in the range of 0 to 100 (0 to 100%) while the PID instruction is being executed. While PID instruction is in manual mode, manual mode output manipulated variable is not stored.

Operation status (S1+2)

Indicates the PID instruction execution status or error status.

- X in the table indicates the elapsed time from the start of AT until the set point is reached. X is incremented by 1 every 10 minutes. 9 is stored if the elapsed time is equal to or longer than 90 minutes.
- x in the table indicates the elapsed time from the start of PID instruction until the set point is reached. x is incremented by 1 every 10 minutes. 9 is stored if the elapsed time is equal to or longer than 90 minutes.
- If an error code (status code value is equal to or greater than 100) is set for the operation status, processing for auto tuning and PID control is canceled. Set the correct parameters and then turn on the PID instruction input once again.

| Status code | Status description | Status classification |
|-------------|---|--------------------------|
| 1X | Auto tuning in progress | AT is normally executed |
| 2X | Auto tuning ended | |
| 5x | P/PI/PID control in progress | PID is normally executed |
| 6x | Set point is reached (Changes from 5x to 6x once the set point is reached.) | |
| 103 | Output manipulated variable restriction upper limit value < output manipulated variable restriction lower limit value was set. | PID execution stop |
| 104 | A value was set for the AT bias that does not satisfy process variable minimum value \leq AT bias \leq process variable maximum value. | PID execution stop |
| 106 | A value was set for the set point that does not satisfy process variable minimum value \leq set point \leq process variable maximum value. | PID execution stop |
| 109 | Process variable > process variable maximum value or process variable < process variable minimum value was set. | PID execution stop |
| 120 | The control mode was set to a value other than 0 to 3. | PID execution continues |
| 121 | The sampling period was set to 0 or 10,001 or greater. | PID execution continues |
| 122 | The proportional band was set to 0 or a value of 10,001 or greater. | PID execution continues |
| 123 | The derivative gain was set to 0 or a value of 101 or greater. | PID execution continues |
| 124 | The integral start factor (ARW) was set to a value of 101 or greater. | PID execution continues |
| 125 | A value was set for the upper limit alarm value that does not satisfy lower limit alarm value < upper limit alarm value \leq process variable maximum value. | PID execution continues |
| 126 | A value was set for the lower limit alarm value that does not satisfy process variable minimum value \leq lower limit alarm value < upper limit alarm value. | PID execution continues |
| 127 | The output manipulated variable restriction upper limit value was set to a value between 101 to 10,000 or 10,100 to 65,535. | PID execution continues |
| 128 | The output manipulated variable restriction lower limit value was set to a value of 101 or higher. PID execution continues | PID execution continues |
| 129 | The output manipulated variable rate of change was set to a value of 101 or higher. | PID execution continues |
| 130 | The manual mode output manipulated variable was set to a value that does not satisfy output manipulated variable restriction lower limit value \leq manual mode output manipulated variable \leq output manipulated variable restriction upper limit value. | PID execution continues |
| 131 | The proportional band offset value was set to a value that is not between -100 to 100. | PID execution continues |
| 132 | The control cycle was set to 0 or a value of 501 or greater. | PID execution continues |

Output manipulated variable (% value) (S1+18)

Shows the output manipulated variable in the range of -32,768 to +32,767 (-327.68% to +327.67%) while the PID instruction is being executed. The output manipulated variable (% value) is unstable while auto tuning is executed. In manual mode, the manual mode output manipulated variable value is not stored.

S2: Initialization Input

When the initialize input is on, the control registers (data registers) are overwritten with the values configured on the WindLDR input tab, control tab, and output tab. If you want the initialization to be performed just one time, please use a SOTU (shot up) or a SOTD (shot down) instruction.

S3: Control Relay

| Device | Function | Setting details | R/W |
|----------------------|--|--|-----|
| S3+0 | Control action | 0 (OFF): Reverse control action 1 (ON): Direct control action | R |
| S3+1 | Auto/manual mode | 0 (OFF): Auto 1 (ON): Manual | R/W |
| S3+2 | Output manipulated variable limit enable | 0 (OFF): Disabled 1 (ON): Enabled (operates with S1+14, 15 settings) | R/W |
| S3+3 | High alarm output | Turns on when process variable (S1+0) \geq high alarm value (S1+3). | R |
| S3+4 | Low alarm output | Turns on when process variable (S1+0) \leq low alarm value (S1+4). | R |
| S3+5 | Control output | Turns on and off according to the control period and output manipulated variable. | R |
| S3+6 | AT execution | Starts auto tuning when execute auto tuning is turned on. Stops auto tuning if execute auto tuning is turned off while auto tuning is executed. | R/W |
| S3+7 | AT complete output | Turns on after auto tuning ends | R |
| S3+8 to S3+15 | — Reserved — | — | — |

Operation action (S3+0)

In direct control action, PID instruction operates to increase the output manipulated variable when the process variable is higher than the set point. Cooling equipment uses this operation. In reverse control action, PID instruction operates to increase the output manipulated variable when the process variable is lower than the set point. Heating furnaces uses this operation.

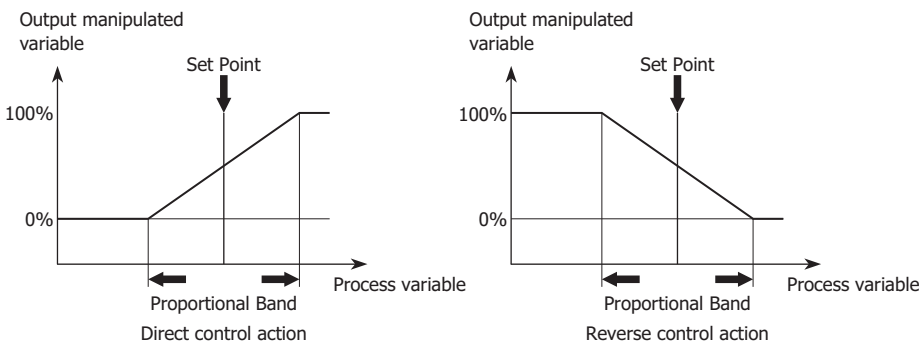

Auto/manual mode (S3+1)

In auto mode, PID instruction controls the output according to the manipulated variable calculated by the PID instruction. In manual mode, PID instruction controls the output with the manual mode output manipulated variable (S1+17). To use manual mode, you must set the manual mode output manipulated variable in advance.

Output manipulated variable limit enable (S3+2)

You can enable or disable the output manipulated variable restriction using the output manipulated variable upper limit value (S1+14) and the output manipulated variable lower limit value (S1+15).

High alarm output (S3+3)

Turns on if the process variable (S1+0) is higher than or equal to the high alarm value (S1+3). This is read-only data.

Low alarm output (S3+4)

Turns on if the process variable (S1+0) is lower than or equal to the low alarm value (S1+4). This is read-only data.

Control output (S3+5)

When PID instruction is in auto mode, the control output turns on and off according to the manipulated variable calculated by the PID instruction and the control period (S1+21). When PID instruction is in manual mode, the control output turns on and off according to the manual mode output manipulated variable (S1+17) and the control period.

AT execution (S3+6)

When the execute auto tuning is turned on, auto tuning is initiated. Once auto tuning is finished, it is turned off automatically. The auto tuning is terminated if it is turned off while auto tuning is executed.

AT complete output (S3+7)

The auto tuning completion output is turned on when the auto tuning is successfully completed.

PID Control

PID control performs adjustment operations to cancel the deviation between a single set point and the process variable that is present in normal temperature control. The types of PID control that can be used with the Touch are as follows.

■Proportional control

Proportional control outputs the manipulated variable in the proportional band that is proportional to the deviation between the set point and the process variable. The output is turned on until the process variable reaches the A point (the proportional band), and when it exceeds this (it enters the proportional band), the control output starts to be turned on and off at the control cycle, and then when the set point is exceeded, the control output is turned completely off. Along with the rise in temperature from the A point to the set point, the control output on time becomes shorter and the off time becomes longer. An offset always occurs with Proportional control. The P action is suitable for processes with no wasted time such as gas pressure control and level control. When set to Proportional control, integral time and derivative time are automatically ignored.

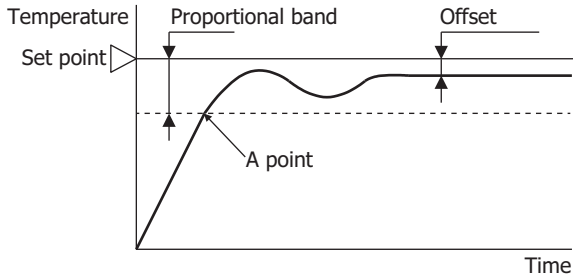

- When the proportional band is made smaller, the control output turns on or off from near the set point, so the time until the process variable rises in temperature to the set point decreases and the offset also becomes smaller, but hunting increases.
- When the proportional band is made larger, the control output turns on or off from a temperature considerably lower than the target temperature, so auto tuning and hunting eliminate, but it takes time until the process variable rises in temperature to the set point and the offset between the set point and the process variable becomes larger.

■PI control

The I action automatically corrects the offset generated by Proportional control. However, for rapid changes in temperature due to disturbances, it will take time until the temperature stabilizes. The PI action is suitable for temperature control with a slow rate of change. When set to PI control, derivative time is automatically 0.

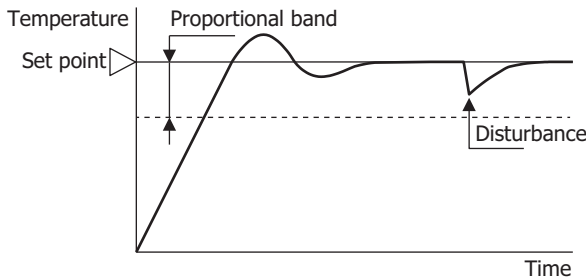

- If the integral time is too small, I (integral) control becomes more powerful and the offset can be corrected in a short amount of time, but this may cause long cycles of hunting.
- If the integral time is too large, I (integral) control becomes weaker and it takes time to correct the offset.

■PD control

Compared to Proportional control, PD control increases the response to rapid temperature changes due to disturbances, stabilizes control in a short amount of time, and attempts to improve the transient response characteristics. PD control is suitable to temperature control with a fast rate of change. When set to PD control, integral time is automatically 0.

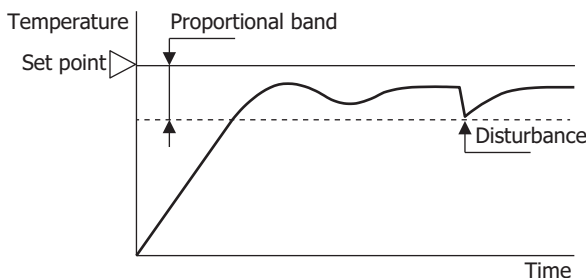

- When the derivative time is decreased, the D (derivative) control becomes weaker and the response to rapid temperature changes becomes slower. The action to control rapid temperature increases also becomes weaker, so the rise in temperature time to the set point will become faster, but overshooting the set point will occur more easily.
- When the derivative time is increased, the D (derivative) control becomes more powerful and the response to rapid temperature changes becomes faster. The action to control rapid temperature increases also becomes more powerful, so the rise in temperature time to the set point will become slower, but overshooting the set point will occur less easily.

■ PID control

PID controls overshooting and hunting in Proportional control, corrects the offset in I (integral) control, and makes rapid temperature changes due to disturbances converge on the set point in D (derivative) control. Ideal temperature control can be performed by using PID control. The parameters for the proportional band, integral time, derivative time, and ARW in PID control can be automatically set with auto tuning.

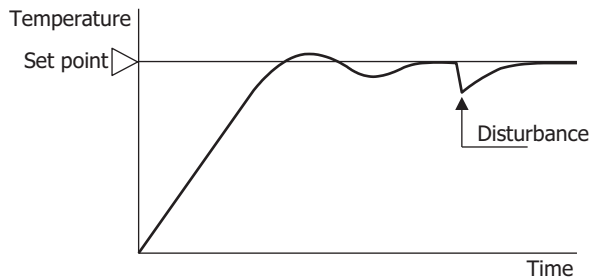

Auto Tuning (AT)

Optimal temperature control parameters will differ according to the characteristics of the subject to control. When performing PID control, the proportional band (P), integral time (I), and derivative time (D) can be automatically set by executing auto tuning.

- Perform auto tuning during test operation.
- When auto tuning is executed near normal temperatures, temperature fluctuations cannot be imposed, so auto tuning may not end normally. In such cases, set the values for P, I, and D manually.
- When auto tuning is executed once, so long as the process is not changed, it is not necessary to execute auto tuning again.

■ Auto tuning (AT)

In order to automatically set the proportional band (P), integral time (I), and derivative time (D), fluctuations must be forcibly imposed on the subject to control to set each value to the optimal value. In order to perform optimal auto tuning, fluctuations must be imposed when the process variable has reached a value near the set point. Fluctuations can be imposed when the process variable is near the set point by setting the AT bias. The relationship between the set point, AT bias, auto tuning start point, and fluctuation start point is as follows.

Process variable (PV) ≤ set point (SP) - AT bias setting value

When the AT bias setting is set to 20°C, fluctuations will start when the process variable (PV) reaches a temperature 20°C lower than the set point (SP).

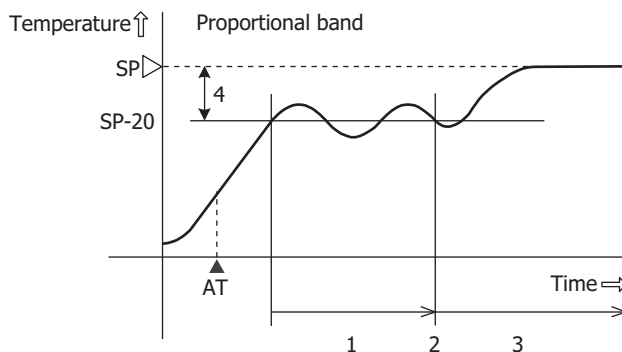

1. Measuring PID constants
2. Calculate PID constants
3. Control with the PID constants set with AT
4. AT bias setting value (20)

▲ AT: When the AT execution bit is turned on

Set point (SP) - AT bias setting value < process variable (PV) < set point (SP) + AT bias setting value

Fluctuations will start when the process variable (PV) reaches the set point (SP).

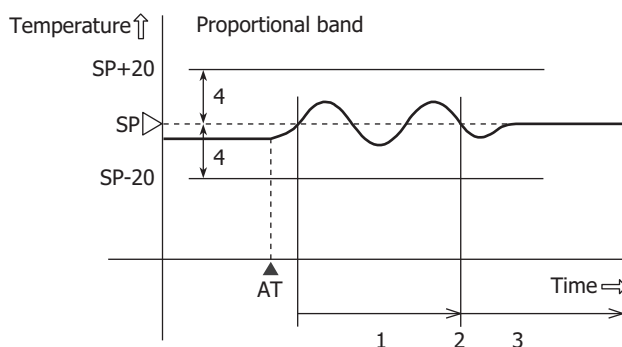

1. Measuring PID constants
2. Calculate PID constants
3. Control with the PID constants set with AT
4. AT bias setting value (20)

▲ AT: When the AT execution bit is turned on

28: PID INSTRUCTION

Process variable (PV) \geq set point (SP) + AT bias setting value

When the AT bias setting is set to 20°C, fluctuations will start when the process variable (PV) reaches a temperature 20°C higher than the set point (SP).

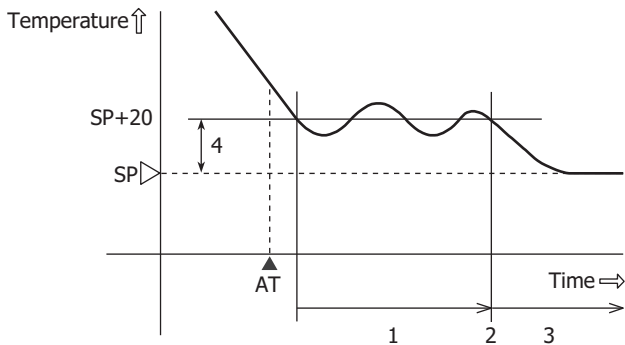

1. Measuring PID constants
2. Calculate PID constants
3. Control with the PID constants set with AT
4. AT bias setting value (20)

▲ AT: When the AT execution bit is turned on

■ To execute auto tuning (AT)

To execute auto tuning, turn on the auto tuning execution flag (S3+6) when the PID instruction input is on. The values for P, I, and D will be automatically calculated. While auto tuning is executing, 1 is stored in the operation status (S1+2).

When auto tuning ends, the auto tuning execution flag (S3+6) turns off automatically, 2 is stored in the operation status (S1+2), and the auto tuning completed output (S3+7) turns on.

■ To cancel auto tuning (AT) execution

To cancel auto tuning while it is executing, turn off the auto tuning execution flag (S3+6). When the auto tuning execution flag (S3+6) is turned off, auto tuning stops, 2 is stored in the operation status (S1+2), and the auto tuning completed output (S3+7) turns on.

If auto tuning is canceled without completing, the values for P, I, and D are restored to the values before auto tuning was executed.

PID Monitor

Function Description

While PID instructions are executed, you can graphically monitor the PID instruction parameters. From the PID monitor dialog box, you can directly change the values of data registers and internal relays used by the PID instruction, and check the operation of the PID instruction while adjusting the PID control parameters.

Note: The PID monitor operates according to the PID instruction settings in the ladder program displayed on the WindLDR and not according to the settings in the PLC. If the device allocations for the PID instruction in the PLC and the PID instruction in WindLDR are different, the PID instruction is not correctly monitored.

Starting the PID Monitor

Operation Procedure

1. From the WindLDR menu bar, select **Online > Monitor > Monitor**.
The monitor starts.

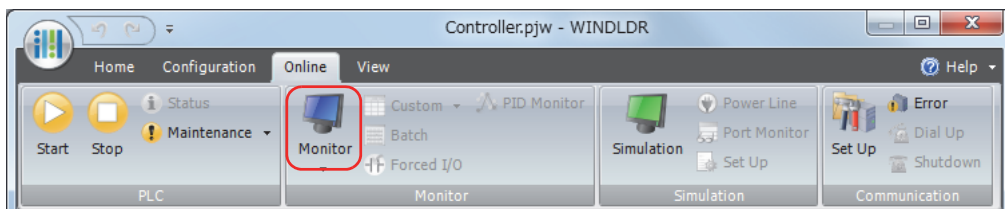

2. From the WindLDR menu bar, select **Online > Monitor > PID Monitor**.
The PID Monitor dialog box is displayed.

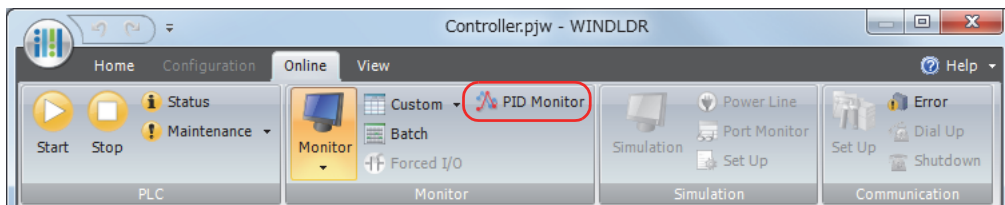

3. On the PID Monitor dialog box, click  button (show/hide PID monitor table).
The PID monitor table is displayed.

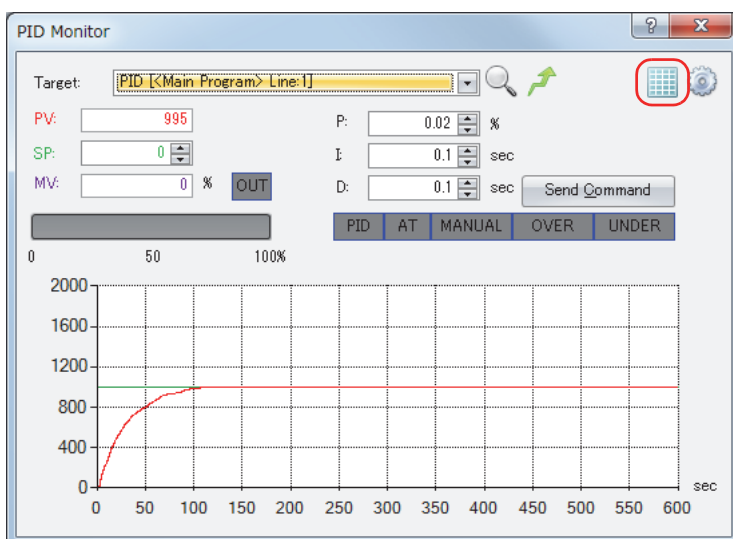

PID Monitor Dialog Box

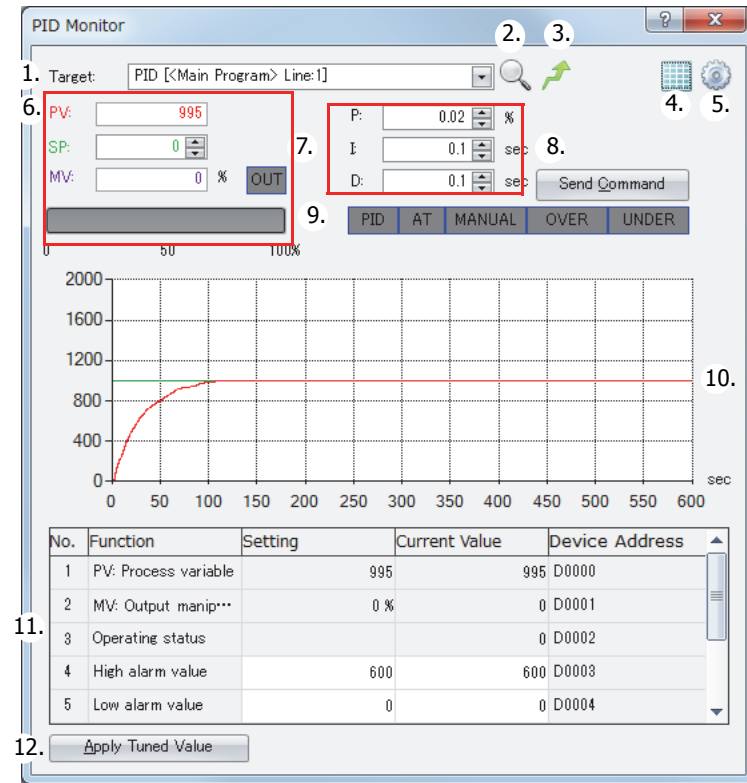

1. PID instruction list

Select the PID instruction to monitor. All PID instructions in the ladder program opened in WindLDR are displayed. The PID instructions can be identified by the program name and line number in which the instruction is used.

2. Refer to PID settings

Opens a dialog box for the PID instruction being monitored so that you can confirm the settings.

3. Jump to target PID instruction

Moves the cursor of the ladder editor to the position of the PID instruction being monitored.

4. Show/hide PID monitor table

You can show or hide **PID Monitor Table** (11) and **Apply Configured Values** button (12).

5. PID monitor settings

Opens the PID Monitor Settings dialog box. For details, see "PID Monitor Settings Dialog Box" on page 28-21.

6. Primary parameters panel

You can check the values of the process variable (PV), set point (SP), and manipulated variable (MV). For the MV, the analog value can be checked with the horizontal bar graph, and the digital value (on/off) can be checked with the color of the OUT indicator. When the OUT indicator is white, the output is off. When it is green, the output is on.

The colors of the values for the process variable (PV), set point (SP), and manipulated variable (MV) can be changed in the PID Monitor Settings dialog box. For details, see "PID Monitor Settings Dialog Box" on page 28-21.

7. PID parameters panel

You can check the values of the proportional band (P), integral time (I), and derivative time (D).

8. Send Command

You can send a command to the Touch to execute/stop AT for PID control and to switch manual/auto mode. Click this button to display a popup menu and click the menu to send the command.

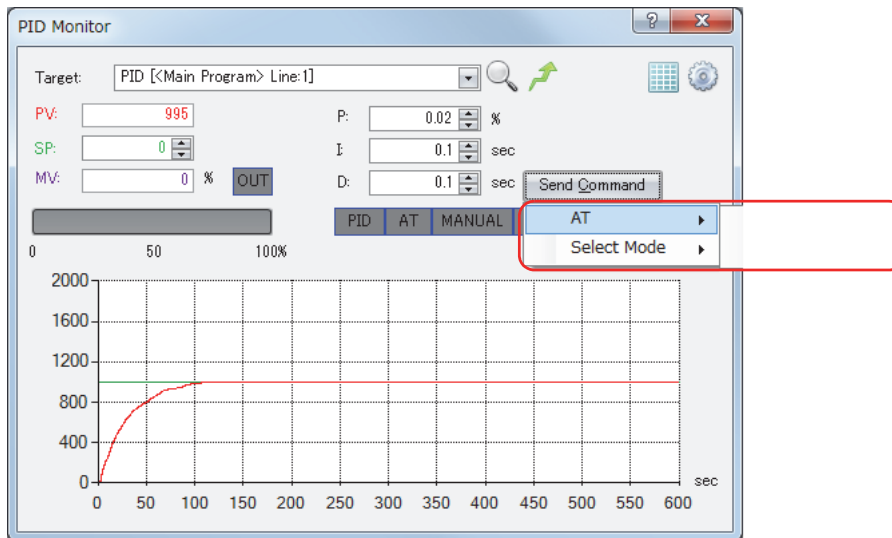

9. Status indicators

You can check the primary statuses for PID control with the colored indicators.

| Indicator name | Background color | Status |
|----------------|------------------|--|
| PID | White | PID control stopped |
| | Green | PID control is executed |
| AT | White | AT stopped |
| | Green | AT is being executed |
| MANUAL | White | Auto mode |
| | Green | Manual mode |
| OVER | White | Normal operation |
| | Red | The process variable has exceeded the upper limit alarm value. |
| UNDER | White | Normal operation |
| | Red | The process variable has fallen below the lower limit alarm value. |

10. Trend graph

You can monitor the values of the process variable (PV), set point (SP), manipulated variable (MV), high alarm value, and low alarm value with the trend graph. Showing/hiding values, colors, the upper limit value, and the lower limit value can be configured in the PID Monitor Settings dialog box. For details, see "PID Monitor Settings Dialog Box" on page 28-21.

Note: When plots on the trend graph reach the right edge of the graph, the center of the graph moves to the left edge and the new log information is displayed from the center of the graph. You can check the past log information by moving the scrollbar. The log information retains a maximum of 10,000 items of information. When the log information has reached 10,000 items of information, the log information is deleted from the oldest items, and the new log information is recorded. The log information displayed on the trend graph is deleted when the dialog box is closed or when the PID instruction being monitored is changed.

11. PID monitor table

You can check the function name, current value, and device address for data registers and internal relays used by the PID instruction. The current values displayed in white cells can be changed. Showing/hiding items can be changed in the PID Monitor Settings dialog box. For details, see "PID Monitor Settings Dialog Box" on page 28-21.

12. Apply Configured Values

By clicking this button, you can reflect the PID control parameters adjusted in **PID monitor table** (11) as the initial setting values for the PID instruction selected in **PID instruction list** (1). To store the reflected initial setting values in the module, you must end the monitor and download the program to the module.

Changing PID Monitor Settings

Operation Procedure

1. From the WindLDR menu bar, select **Online > Monitor > Monitor**.
The monitor starts.

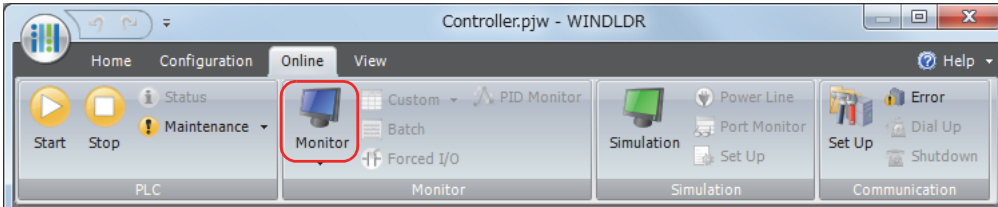

2. From the WindLDR menu bar, select **Online > Monitor > PID Monitor**.
The PID Monitor dialog box is displayed.

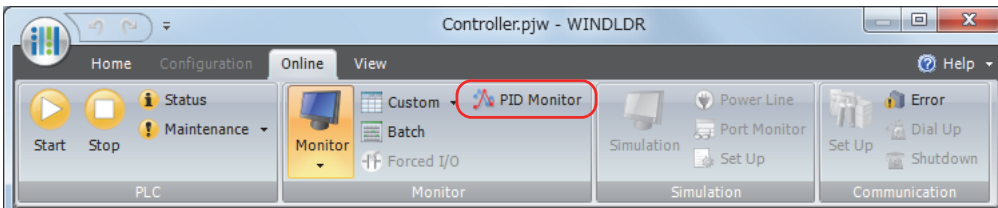

3. In the PID Monitor dialog box, click  button (PID monitor settings).
The PID Monitor Settings dialog box is displayed.

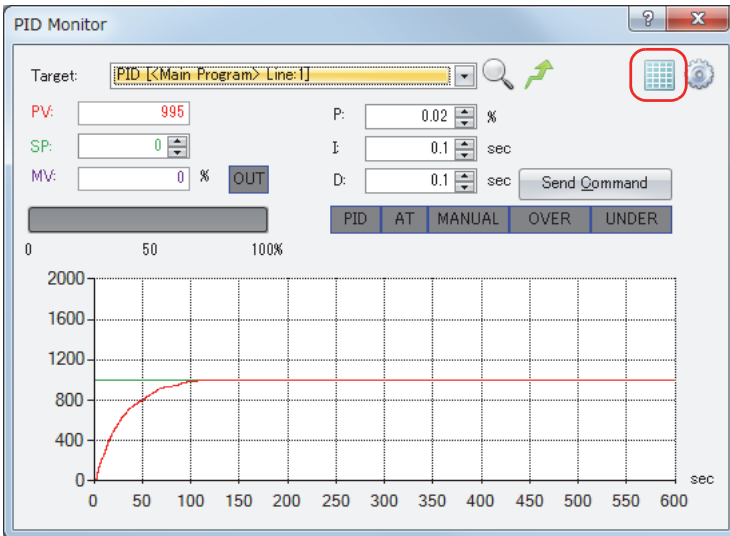

PID Monitor Settings Dialog Box

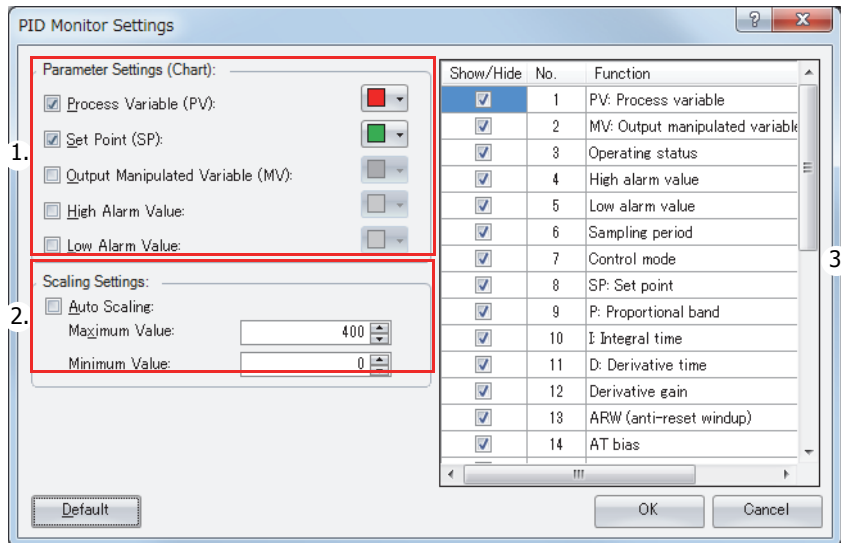

1. Trace Selection

You can show/hide and specify the color of the process variable (PV), set point (SP), manipulated variable (MV), high alarm value, and low alarm value on the trend graph in the PID Monitor dialog box. Select the check box for each item to show it, or clear the check box to hide it. The color of the button on the right side of each item is the display color for that item. Press ▼ button to display the list of colors and select the color to change the display color. The selected color is applied to the primary parameters panel in the PID Monitor dialog box.

2. Scaling Settings

You can set the scaling for the vertical axis of the trend graph in the PID Monitor dialog box. When the auto scaling check box is selected, the Maximum Value and the Minimum Value for the vertical axis are automatically adjusted for the values displayed on the trend graph. When the check box is cleared, the Maximum Value and the Minimum Value are set according to the entered values.

3. PID monitor table settings

You can show or hide the items on the PID monitor table. Select the check box for each item to show it, or clear the check box to hide it.

APPENDIX

Execution Times for Instructions

Execution times for basic and advanced instructions of the SmartAXIS are listed below.
Repeat is not assigned for any device.

| Instruction | Device and Condition | Execution Time (μs) | |
|------------------------|----------------------|----------------------|-----------------|
| | | SmartAXIS Pro / Lite | SmartAXIS Touch |
| LOD, LODN | — | 0.85 | 1.58 |
| | Using data register | 2.01 | 2.71 |
| OUT, OUTN | — | 0.81 | 1.13 |
| | Using data register | 1.92 | 2.17 |
| SET, RST | — | 0.81 | 1.08 |
| | Using data register | 1.96 | 2.17 |
| AND, ANDN, OR, ORN | — | 0.65 | 0.81 |
| | Using data register | 1.94 | 2.46 |
| AND LOD, OR LOD | — | 0.57 | 0.85 |
| BPS | — | 0.94 | 0.99 |
| BRD | — | 0.94 | 0.99 |
| BPP | — | 0.94 | 0.99 |
| SOTU, SOTD | — | 1.22 | 2.16 |
| TML, TIM, TMH, TMS | — | 3.19 | 5.45 |
| TMLO, TIMO, TMHO, TMSO | — | 3.19 | 5.45 |
| CNT, CDP, CUD | — | 3.16 | 4.33 |
| CNTD, CDPD, CUDD | — | 24.86 | 126.1 |
| SFR, SFRN | N bits | — | 42.7+0.4n |
| CC=, CC>= | — | 2.06 | 2.38 |
| DC=, DC>= | — | 2.06 | 2.94 |
| MCS, MCR, JMP, JEND | — | — | 0.91 |
| END | — | — | — |
| NOP | — | — | — |
| MOV, MOVN (W, I) | M → M | 19.36 | 44.7 |
| | D → D | 4.16 | 4.30 |
| MOV, MOVN (D, L) | M → M | 19.36 | 84.5 |
| | D → D | 19.36 | 84.5 |
| MOV (F) | — | 19.36 | 84.5 |
| IMOV, IMOVN (W) | M+D→M+D | 15.86 | 84.4 |
| | D+D→D+D | 8.16 | 7.70 |
| IMOV, IMOVN (D) | D+D → D+D (D) | 22.66 | 87.9 |
| IMOV (F) | — | 22.66 | 87.9 |
| IBMV, IBMVN | M+D→M+D | 15.76 | 47.5 |
| | D+D→D+D | 15.76 | 47.5 |
| BMOV | D → D | 21.36 + 1.3n | 90.3+1.4n |
| NSET (W, I) | D → D | 2.86 + 1.6n | 1.8+2.5n |
| NSET (D, L) | D → D | 2.86 + 1.6n | 1.8+83.0n |
| NSET (F) | D → D | 2.86 + 1.6n | 1.8+83.0n |
| NRS (W, I) | D, D → D | 11.68 | 16.5 |
| NRS (D, L) | D, D → D | 88.96 | 732.5 |

APPENDIX

| Instruction | Device and Condition | Execution Time (μs) | |
|---|--------------------------|----------------------|-----------------|
| | | SmartAXIS Pro / Lite | SmartAXIS Touch |
| NRS (F) | D, D → D | 88.96 | 732.5 |
| XCHG (W) | D ↔ D | 4.86 | 5.10 |
| XCHG (D) | D ↔ D | 33.76 | 166.5 |
| TCCST (W) | D → T | 4.49 | 4.81 |
| TCCST (D) | D → T | 12.3 | 85.5 |
| CMP (=, <>, <, >, <=, >=) (W, I) | D ↔ D → M | 14.26 | 47.0 |
| CMP (=, <>, <, >, <=, >=) (D, L) | D ↔ D → M | 28.06 | 127.5 |
| CMP (=, <>, <, >, <=, >=) (F) | D ↔ D → M | 28.06 | 127.5 |
| ICMP (>=) | D ↔ D ↔ D → M | 36.56 | 169.5 |
| ICMP (D, L, F) | D ↔ D ↔ D → M | 57.36 | 557.5 |
| LC (=, <>, <, >, <=, >=) (W, I) | D ↔ D | 4.68 | 5.00 |
| LC (=, <>, <, >, <=, >=) (D, L) | D ↔ D | 19.66 | 86.5 |
| LC (=, <>, <, >, <=, >=) (F) | D ↔ D | 19.66 | 86.5 |
| ADD (W, I) | M + M → D | 20.86 | 86.5 |
| | D + D → D | 13.76 | 47.3 |
| ADD (D, L) | M + M → D | 34.86 | 166.3 |
| | D + D → D | 34.86 | 167.3 |
| ADD (F) | D + D → D | 35.86 | 171.9 |
| SUB (W, I) | M - M → D | 20.86 | 86.5 |
| | D - D → D | 13.76 | 47.3 |
| SUB (D, L) | M - M → D | 34.86 | 166.3 |
| | D - D → D | 34.86 | 167.3 |
| SUB (F) | D - D → D | 35.86 | 171.9 |
| MUL (W, I) | M × M → D | 20.36 | 86.5 |
| | D × D → D | 13.36 | 47.3 |
| MUL (D, L) | M × M → D | 34.76 | 166.3 |
| | D × D → D | 34.76 | 167.3 |
| MUL (F) | D × D → D | 35.76 | 171.9 |
| DIV (W, I) | M ÷ M → D | 14.36 | 86.5 |
| | D ÷ D → D | 6.36 | 9.80 |
| DIV (D, L) | M ÷ M → D | 34.96 | 166.3 |
| | D ÷ D → D | 34.96 | 167.3 |
| DIV (F) | D ÷ D → D | 36.66 | 171.9 |
| INC (W, I) | — | 11.86 | 44.7 |
| INC (D, L) | — | 25.66 | 124.5 |
| DEC (W, I) | — | 11.86 | 44.7 |
| DEC (D, L) | — | 25.66 | 124.5 |
| ROOT (W) | $\sqrt{D} \rightarrow D$ | 7.36 | 5.50 |
| ROOT (D) | $\sqrt{D} \rightarrow D$ | 21.76 | 86.7 |
| ROOT (F) | $\sqrt{D} \rightarrow D$ | 19.66 | 886.5 |
| SUM (W, I) | D, D → D | 13.16 + 0.8n | 47.6+1.1n |
| SUM (D, L) | D, D → D | 21.36 + 7.6n | 90.5+41.5n |
| SUM (F) | D, D → D | 21.36 + 9.2n | 90.5+45.0n |
| ANDW, ORW, XORW (W) | M · M → D | 20.16 | 46.1 |
| | D · D → D | 5.36 | 5.70 |
| ANDW, ORW, XORW (D) | D · D → D | 27.06 | 127.1 |
| SFTL, SFTR | N_B = 100 | 18.76 | 56.1 |

| Instruction | Device and Condition | Execution Time (μ s) | |
|------------------|----------------------------|---------------------------|-----------------|
| | | SmartAXIS Pro / Lite | SmartAXIS Touch |
| BCDLS | D \rightarrow D, S1 = 1 | 10.56 | 49.9 |
| WSFT | D \rightarrow D | 22.56 | 91.3 |
| ROTL, ROTR (W) | D, bits = 1 | 12.16 | 44.9 |
| HTOB (W) | D \rightarrow D | 4.84 | 10.5 |
| BTOH (W) | D \rightarrow D | 4.92 | 11.1 |
| HTOA (W) | D \rightarrow D | 7.96 | 13.7 |
| ATOH (W) | D \rightarrow D | — | 6.0 |
| BTOA (W) | D \rightarrow D | — | 13.7 |
| ATOB (W) | D \rightarrow D | — | 56.3 |
| ENCO (W) | M \rightarrow D, 16 bits | — | 6.9 |
| DECO | D \rightarrow M | — | 50.0 |
| BCNT | M \rightarrow D, 16 bits | — | — |
| ALT | — | 10.86 | 42.7 |
| CVDT | W, I, D, L \rightarrow F | — | 53.0 |
| | F \rightarrow W, I, D, L | — | 56.3 |
| DTDV (W) | D \rightarrow D | — | 8.90 |
| DTCB (W) | D \rightarrow D | — | 10.4 |
| SWAP (W) | — | 4.22 | 8.9 |
| SWAP (D) | — | 19.06 | 89.7 |
| WEEK | — | — | — |
| YEAR | — | — | — |
| MSG | — | — | — |
| LABEL | — | — | — |
| LJMP | — | — | — |
| LCAL | — | — | — |
| LRET | — | — | — |
| DJNZ | — | — | — |
| IOREF | — | — | 46.8 |
| HSCRF | — | — | 46.8 |
| DI | — | — | 90.3 |
| EL | — | — | 54.1 |
| XYFS | — | — | — |
| CVXTY | — | — | — |
| CVYTX | — | — | — |
| AVRG (W, I) | S3 = 10 | — | 6.38 |
| AVRG (D, L) | S3 = 10 | — | 49.5 |
| AVRG (F) | S3 = 10 | — | 55.1 |
| PULS | — | — | — |
| PWM | — | — | — |
| RAMP | — | — | — |
| ZRN | — | — | — |
| ARAMP | — | — | — |
| DTML, DTIM, DTMH | — | — | 60.2 |
| DTMS | — | — | 63.0 |
| TTIM | — | — | 60.3 |
| RAD | F \rightarrow F | — | 143.9 |
| DEG | F \rightarrow F | — | 143.9 |

| Instruction | Device and Condition | Execution Time (μs) | |
|--------------|----------------------|----------------------|-----------------|
| | | SmartAXIS Pro / Lite | SmartAXIS Touch |
| SIN, COS | F → F | 36.96 | 161.1 |
| TAN | F → F | 34.66 | 149.1 |
| ASIN, ACOS | F → F | 81.36 | 618.9 |
| ATAN | F → F | 72.96 | 616.5 |
| LOGE, LOG10 | F → F | 43.56 | 206.0 |
| EXP | F → F | 37.56 | 172.5 |
| POW | F → F | 47.36 | 191.0 |
| FIFO | — | — | 129.0 |
| FIEX | — | — | 129.0 |
| FOEX | — | — | 129.0 |
| NDSRC (W, I) | D, D, D → D | — | 19.5 |
| NDSRC (D, L) | D, D, D → D | — | 782.5 |
| NDSRC (F) | D, D, D → D | — | 782.5 |
| TADD | — | — | 54.4 |
| TSUB | — | — | 54.4 |
| HOUR | D → D, Y, D | — | 20.6 |
| HTOS | — | — | 52.7 |
| STOH | D → D | — | 92.1 |
| TXD | — | — | — |
| RXD | — | — | — |
| ETXD | — | — | — |
| ERXD | — | — | — |
| DLOG | — | — | — |
| TRACE | — | — | — |
| SCRPT | — | — | — |
| PID | — | — | — |

Processing in One Scan

While the SmartAXIS is running, the SmartAXIS performs operations repeatedly such as input refreshing, ladder program processing, and error checking.

A *scan* is the execution of all instructions from address zero to the END instruction. The time required for this execution is referred to as one *scan time*. The scan time varies with respect to program length.

The current value of the scan time is stored to special data register D8023 (scan time current value), and the maximum value of the scan time is stored to special data register D8024 (scan time maximum value). These values can be viewed on the PLC status screen of WindLDR while monitoring on a computer.

Executing Program Instructions

During the scan time, program instructions are processed sequentially starting with the first line of the ladder program, except for interrupt program execution. One scan time of a ladder program is approximately equal to the total execution time of each instruction shown on preceding pages.

Watchdog Timer

The watchdog timer monitors the time required for one program cycle (scan time) to prevent hardware malfunction. When the processing time for one scan exceeds the allowed time, a watchdog timer error occurs and the system is reset. If this is the case, place NOP instructions in the ladder diagram. The NOP instruction resets the watchdog timer. For details on the watchdog timer, see Chapter 5 "Special Functions" – "Watchdog Timer" in the SmartAXIS Pro/Lite User's Manual.

Breakdown of END Processing Time

The END processing time depends on the SmartAXIS settings and system configuration. The maximum values for the END processing time are as follows.

| Item | Processing Time |
|----------------|-----------------|
| END processing | 640 μ s |

Instruction Bytes

The byte quantities for basic and advanced instructions are listed below.

| Basic Instruction | Qty of Bytes | | Basic Instruction | Qty of Bytes | |
|-------------------|-------------------------------|----------------------|-------------------|-------------------------------|----------------------|
| | When not using data registers | Using data registers | | When not using data registers | Using data registers |
| LOD | 4 | 8 | TMLO | 8 | — |
| LODN | 4 | 8 | TIMO | 8 | — |
| OUT | 4 | 8 | TMHO | 8 | — |
| OUTN | 4 | 8 | TMSO | 8 | — |
| SET | 4 | 8 | CNT | 8 | — |
| RST | 4 | 8 | CDP | 8 | — |
| AND | 4 | 8 | CUD | 8 | — |
| ANDN | 4 | 8 | CNTD | 8 | — |
| OR | 4 | 8 | CDPD | 8 | — |
| ORN | 4 | 8 | CUDD | 8 | — |
| AND LOD | 4 | — | SFR | 8 | — |
| OR LOD | 4 | — | SFRN | 8 | — |
| BPS | 4 | — | CC= | 8 | — |
| BRD | 4 | — | CC>= | 8 | — |
| BPP | 4 | — | DC= | 8 | — |
| SOTU | 4 | — | DC>= | 8 | — |
| SOTD | 4 | — | MCS | 4 | — |
| TML | 8 | — | MCR | 4 | — |
| TIM | 8 | — | JMP | 4 | — |
| TMH | 8 | — | JEND | 4 | — |
| TMS | 8 | — | END | 4 | — |

APPENDIX

| Advanced Instruction | Qty of Bytes |
|---------------------------|--------------|
| NOP | 4 |
| MOV, MOVN | 12 to 16 |
| IMOV, IMOVN | 16 |
| IBMV, IBMVN | 16 to 24 |
| BMOV | 12 to 16 |
| NSET | 12 to 1540 |
| NRS | 12 to 20 |
| XCHG | 12 to 16 |
| TCCST | 12 to 16 |
| CMP (=, <>, <, >, <=, >=) | 16 to 24 |
| ICMP>= | 16 to 28 |
| LC (=, <>, <, >, <=, >=) | 12 to 20 |
| ADD, SUB, MUL, DIV | 16 to 24 |
| INC, DEC | 8 |
| ROOT | 12 to 20 |
| SUM | 16 to 20 |
| ANDW, ORW, XORW | 16 to 24 |
| SFTL, SFTR | 12 |
| BCDLS | 12 to 16 |
| WSFT | 12 to 20 |
| ROTL, ROTR | 12 |
| HTOB, BTOH | 12 to 16 |
| HTOA | 12 to 20 |
| ATOH | 12 to 20 |
| BTOA | 12 to 20 |
| ATOB | 12 to 20 |
| ENCO | 12 to 16 |
| DECO | 12 to 16 |
| BCNT | 12 to 20 |
| ALT | 8 |
| CVDT | 12 to 20 |
| DTDV | 12 to 16 |
| DTCB | 12 to 16 |
| SWAP | 12 to 16 |
| WEEK | 20 to 532 |
| YEAR | 24 to 216 |
| MSG | 12 or more |
| LABEL | 8 |
| LJMP | 8 to 12 |
| LCAL | 8 to 12 |
| LRET | 8 |
| DJNZ | 12 to 16 |
| IOREF | 12 |

| Advanced Instruction | Qty of Bytes |
|----------------------------|--------------|
| HSCRF | 8 |
| DI | 8 |
| EI | 8 |
| XYFS | 20 to 268 |
| CVXTY, CVYTX | 16 to 20 |
| AVRG | 16 to 24 |
| PULS1, PULS2, PULS3, PULS4 | 24 |
| PWM1, PWM2, PWM3, PWM4 | 24 |
| RAMP1, RAMP2 | 28 |
| ZRN1, ZRN2 | 20 |
| ARAMP1, ARAMP2 | 36 to 240 |
| DTML, DTIM, DTMH, DTMS | 16 to 20 |
| TTIM | 8 to 12 |
| RAD | 12 to 16 |
| DEG | 12 to 16 |
| SIN | 12 to 16 |
| COS | 12 to 16 |
| TAN | 12 to 16 |
| ASIN | 12 to 16 |
| ACOS | 12 to 16 |
| ATAN | 12 to 16 |
| LOGE | 12 to 16 |
| LOG10 | 12 to 16 |
| EXP | 12 to 16 |
| POW | 12 to 24 |
| FIFO | 20 to 24 |
| FIEX | 12 |
| FOEX | 12 |
| NDSRC | 16 to 24 |
| TADD | 16 to 20 |
| TSUB | 16 to 20 |
| HOUR | 16 to 24 |
| HTOS | 12 to 16 |
| STOH | 12 to 16 |
| TXD | 16 to 820 |
| RXD | 16 to 820 |
| ETXD | 16 to 820 |
| ERXD | 16 to 820 |
| DLOG | 24 to 276 |
| TRACE | 24 to 276 |
| SCRPT | 12 to 14 |
| PID | 112 |

INDEX

- #
 - 100-ms
 - clock M8122 3-7
 - dual timer 20-1
 - 10-ms
 - clock M8123 3-7
 - dual timer 20-1
 - 1-ms dual timer 20-1
 - 1-sec
 - clock
 - M8121 3-7
 - reset M8001 3-5
 - dual timer 20-1
 - 32-bit Data Storage 4-12
- A**
 - ACOS 21-7
 - ADD 8-1
 - adding counter CNT 5-11
 - addition 8-1
 - advanced instruction
 - ACOS 21-7
 - ADD 8-1
 - ALT 11-18
 - ANDW 9-1
 - applicable SmartAXIS 4-6
 - ASIN 21-6
 - ATAN 21-8
 - ATOB 11-12
 - ATOH 11-7
 - AVRG 18-1
 - BCDLS 10-5
 - BCNT 11-17
 - BMOV 6-9
 - BTOA 11-9
 - BTOH 11-3
 - CMP< 7-1
 - CMP<= 7-1
 - CMP<> 7-1
 - CMP= 7-1
 - CMP> 7-1
 - CMP>= 7-1
 - COS 21-4
 - CVDT 11-19
 - CVXTY 17-2
 - CVYTX 17-3
 - data types 4-10
 - DEC 8-13
 - DECO 11-16
 - DEG 21-2
 - DI 16-1
 - DIV 8-1
 - DJNZ 14-5
 - DTCB 11-22
 - DTDV 11-21
 - DTIM 20-1
 - DTMH 20-1
 - DTML 20-1
 - DTMS 20-1
 - EI 16-1
 - ENCO 11-15
 - EXP 22-3
 - FIEX 23-3
 - FIFO 23-1
 - FOEX 23-3
 - HOUR 24-11
 - HSCRF 15-3
 - HTOA 11-5
 - HTOB 11-1
 - HTOS 24-9
 - IBMV 6-10
 - IBMVN 6-12
 - ICMP>= 7-6
 - IMOV 6-6
 - IMOVN 6-8
 - INC 8-13
 - input condition 4-9
 - IOREF 15-1
 - LABEL 14-1
 - LC< 7-8
 - LC<= 7-8
 - LC<> 7-8
 - LC= 7-8
 - LC> 7-8
 - LC>= 7-8
 - LCAL 14-3
 - list 4-3
 - LJMP 14-1
 - LOG10 22-2
 - LOGE 22-1
 - LRET 14-3
 - MOV 6-1
 - MOVN 6-5
 - MUL 8-1
 - NDSRC 23-5
 - NOP 4-14
 - NRS 6-14
 - NSET 6-13
 - ORW 9-1
 - POW 22-4
 - RAD 21-1
 - ROOT 8-14
 - ROTL 10-8
 - ROTR 10-10
 - RXD 25-7
 - SFTL 10-1
 - SFTR 10-3
 - SIN 21-3
 - STOH 24-10
 - structure 4-9
 - SUB 8-1
 - SUM 8-15
 - SWAP 11-23
 - TADD 24-1
 - TAN 21-5
 - TCCST 6-16
 - TSUB 24-5
 - TTIM 20-3

- TXD 25-1
 - WSFT 10-7
 - XCHG 6-15
 - XORW 9-1
 - XYFS 17-1
 - Advanced instructions
 - ARAMP 19-32
 - DLOG 26-1
 - ERXD 25-21
 - ETXD 25-21
 - PULS 19-1
 - PWM 19-8
 - RAMP 19-15
 - WEEK 12-1
 - YEAR 12-11
 - ZRN 19-26
 - all outputs OFF M8002 3-5
 - ALT 11-18
 - alternate output 11-18
 - AND and ANDN instructions 5-4
 - AND LOD instruction 5-5
 - AND word 9-1
 - ANDW 9-1
 - arc
 - cosine 21-7
 - sine 21-6
 - tangent 21-8
 - ASCII
 - to BCD 11-12
 - to hex 11-7
 - ASIN 21-6
 - ATAN 21-8
 - ATOB 11-12
 - ATOH 11-7
 - average 18-1
 - AVRG 18-1
- B**
- basic
 - instructions 4-1, 5-1
 - BCC (block check character) 25-5, 25-17
 - BCD
 - left shift 10-5
 - to ASCII 11-9
 - to hex 11-3
 - BCDLS 10-5
 - BCNT 11-17
 - bidirectional shift register 5-25
 - binary arithmetic instructions 8-1
 - bit count 11-17
 - block move 6-9
 - BMOV 6-9
 - BMOV/WSFT executing flag M8024 3-6, 6-9, 10-7
 - Boolean computation instructions 9-1
 - Borrow 4-13
 - BPS, BRD, and BPP instructions 5-6
 - breakdown of END processing time 4-5
 - BTOA 11-9
 - BTOH 11-3
 - bytes 4-5, 4-6
- C**
- calendar data
 - write flag M8016 3-5
 - calendar/clock
 - data
 - read error flag M8014 3-5
 - write flag M8020 3-5
 - write/adjust error flag M8013 3-5
 - Carry 4-13
 - carry
 - (Cy) and borrow (Bw) M8003 3-5
 - and borrow 8-16
 - or borrow signals 8-2
 - catch input
 - ON/OFF status M8090-M8095 3-6
 - CC= and CC>= instructions 5-18
 - change
 - counter preset and current values 5-11
 - timer preset and current values 5-8
 - changing
 - preset values for timers and counters 5-17
 - clear button 5-17
 - clearing
 - changed preset values 5-17
 - clock
 - data
 - adjust flag M8021 3-5
 - write flag M8017 3-5
 - instructions 24-1
 - CMP< 7-1
 - CMP<= 7-1
 - CMP<> 7-1
 - CMP= 7-1
 - CMP> 7-1
 - CMP>= 7-1
 - CNT, CDP, and CUD instructions 5-11
 - CNTD, CDPD, and CUDD instructions 5-14
 - common logarithm 22-2
 - communication
 - adapter information D8030 3-12
 - error
 - M8005 3-5
 - mode information (port 2 and port 3) D8026 3-11
 - compare
 - equal to 7-1
 - greater than 7-1
 - or equal to 7-1
 - less than 7-1
 - or equal to 7-1
 - unequal to 7-1
 - Comparing BCC Codes 25-18
 - comparison
 - result
 - 1 M8150 3-7
 - 2 M8151 3-7
 - 3 M8152 3-7
 - M8150, M8151, M8152 7-2, 7-6
 - confirm
 - button 5-17
 - confirming changed preset values 5-17
 - constant 25-15
 - Constant for Verification 25-15
 - conversion
 - linear 17-5
 - type 25-3, 25-9
 - convert

- data type 11-19
 - X to Y 17-2
 - Y to X 17-3
- coordinate conversion instructions 17-1
- COS 21-4
- cosine 21-4
- counter
 - adding (up) counter 5-11
 - and shift register in master control circuit 5-28
 - comparison instructions 5-15
 - double-word
 - adding (up) 5-14
 - dual-pulse reversible 5-15
 - up/down selection reversible 5-16
 - dual-pulse reversible 5-12
 - up/down selection reversible 5-13
- CPU module
 - type information D8002 3-11
- CSV File 26-5, 26-11
- current value
 - change
 - counter 5-11
 - timer 5-8
- CVDT 11-19
- CVXTY 17-2
- CVYTX 17-3

D

- data
 - combine 11-22
 - comparison instructions 7-1
 - conversion
 - error 17-3, 17-4
 - instructions 11-1
 - divide 11-21
 - input 5-22
 - movement
 - timer/counter preset value 5-17
 - swap 11-23
 - type 4-9
 - types for advanced instructions 4-10
- data register
 - comparison instructions 5-20
 - double-word
 - data move 6-2
- DC= and DC>= instructions 5-20
- DEC 8-13
- decimal values and hexadecimal storage 4-10
- DECO 11-16
- decode 11-16
- decrement 8-13
 - jump non-zero 14-5
- default gateway D8092-D8095 3-13
- DEG 21-2
- degree 21-2
- delimiter 25-10
- destination device 4-9
- device
 - addresses 3-1
 - areas discontinuity 4-14
- DI 16-1
- disable
 - interrupt 16-1
- discontinuity of device areas 4-14

- DIV 8-1
- division 8-1
- DJNZ 14-5
- double-word
 - adding counter CNTD 5-14
 - counter 5-14
 - data move in data registers 6-2
 - dual-pulse reversible counter CDPD 5-15
 - up/down selection reversible counter CUDD 5-16
- download
 - program 1-7
- DSR
 - input control signal option 3-14
- DTCB 11-22
- DTDV 11-21
- DTIM 20-1
- DTMH 20-1
- DTML 20-1
- DTMS 20-1
- DTR
 - output control signal option 3-14
- dual/teaching timer instructions 20-1
- dual-pulse reversible counter CDP 5-12

E

- edit user program 1-4
- EI 16-1
- enable
 - interrupt 16-1
- ENCO 11-15
- encode 11-15
- END
 - instruction 5-30
 - processing time, breakdown 4-5
- end
 - delimiter 25-14
- exchange 6-15
- exclusive OR word 9-1
- execution
 - times for instructions 4-1
- EXP 22-3
- expansion
 - data register
 - data writing flag M8027 3-6
 - status M8026 3-6
- exponent 22-3

F

- FIEX 23-3
- FIFO format 23-1
- FIFO 23-1
- file data processing instructions 23-1
- first-in execute 23-3
- first-out execute 23-3
- FOEX 23-3
- format number 17-1, 17-2, 17-3
- forward shift register 5-22

H

- hex to
 - ASCII 11-5
 - BCD 11-1
- hexadecimal storage decimal values 4-10
- high-speed counter
 - comparison output reset M8030, M8040, M8045 3-2
 - gate input M8031, M8041, M8046 3-2

- refresh 15-3
 - reset input M8032, M8042, M8047 3-2
 - HMS to sec 24-9
 - HOUR 24-11
 - hour meter 24-11
 - HSCRF 15-3
 - HTOA 11-5
 - HTOB 11-1
 - HTOS 24-9
- I**
- I/O
 - refresh 15-1
 - IBMV 6-10
 - IBMVN 6-12
 - ICMP>= 7-6
 - IMOV 6-6
 - IMOVN 6-8
 - INC 8-13
 - increment 8-13
 - indirect
 - bit move 6-10
 - bit move not 6-12
 - move 6-6
 - move not 6-8
 - initialize
 - pulse M8120 3-7
 - in-operation output M8125 3-7
 - input
 - condition for advanced instructions 4-9
 - instruction bytes A-5, A-6
 - instructions
 - average 18-1
 - binary arithmetic 8-1
 - Boolean computation 9-1
 - clock 24-1
 - coordinate conversion 17-1
 - data comparison 7-1
 - data conversion 11-1
 - dual/teaching timer 20-1
 - file data processing 23-1
 - logarithm/power 22-1
 - move 6-1
 - program branching 14-1
 - prohibited 5-31
 - shift/rotate 10-1
 - trigonometric function 21-1
 - user communication 25-1
 - interrupt
 - input
 - status M8070-M8075 3-6
 - interval compare greater than or equal to 7-6
 - IOREF 15-1
 - IP address D8084-D8087 3-13
- J**
- JMP and JEND instructions 5-29
 - jump instructions 5-29
- L**
- LABEL 14-1
 - label 14-1
 - call 14-3
 - jump 14-1
 - return 14-3
 - LC< 7-8
 - LC<= 7-8
 - LC<> 7-8
 - LC= 7-8
 - LC> 7-8
 - LC>= 7-8
 - LCAL 14-3
 - linear conversion 17-5
 - list
 - advanced instruction 4-3
 - basic instruction 4-1
 - LJMP 14-1
 - load compare
 - equal to 7-8
 - greater than 7-8
 - or equal to 7-8
 - less than 7-8
 - or equal to 7-8
 - unequal to 7-8
 - LOD and LODN instructions 5-1
 - LOG10 22-2
 - logarithm/power instructions 22-1
 - LOGE 22-1
 - LRET 14-3
- M**
- MAC Address D8078-D8083 3-13
 - maintain outputs while CPU stopped M8025 3-6
 - master
 - control instruction 5-27
 - MCS and MCR instructions 5-27
 - memory
 - cartridge
 - information D8003 3-11
 - Message (MSG) 13-1
 - monitor
 - operation 1-8
 - MOV 6-1
 - move 6-1
 - instructions 6-1
 - not 6-5
 - MOVN 6-5
 - MUL 8-1
 - multi-byte start delimiter 25-11
 - multiple
 - OUT and OUTN 5-2
 - usage of MCS instructions 5-28
 - multiplication 8-1
- N**
- N data
 - repeat set 6-14
 - search 23-5
 - set 6-13
 - natural logarithm 22-1
 - NDSRC 23-5
 - no operation 4-14
 - NOP 4-14
 - NRS 6-14
 - NSET 6-13
- O**
- off-delay
 - 100-ms timer 5-10
 - 10-ms timer 5-10
 - 1-ms timer 5-10
 - 1-sec timer 5-10

- timer 5-10
- opcode 4-9
- operation
 - basics 1-1
- optional cartridge information D8031 3-12
- OR and ORN instructions 5-4
- OR LOD instruction 5-5
- OR word 9-1
- ORW 9-1
- OUT and OUTN
 - instructions 5-1
 - multiple 5-2
- overlapping coordinates 17-6

P

- PID Instruction (PID) 28-1
- PLC Selection 1-2
- PLC status 5-17
- POW 22-4
- power 22-4
 - failure
 - memory protection 5-9
- preset
 - values
 - change counter 5-11
 - change timer 5-8
 - changing 5-17
 - restoring 5-17
- program branching
 - instructions 14-1
 - using with SOTU/SOTD instructions 14-2
 - using with timer instruction 14-2
- programming
 - DI or EI using WindLDR 16-2
- prohibited
 - instructions 5-31
 - ladder programs 5-31
- proximity signal 19-26
- pulse
 - input 5-22

Q

- quit WindLDR 1-8

R

- RAD 21-1
- radian 21-1
- receive 25-7
 - completion output 25-7, 25-19
 - data byte count 25-20
 - digits 25-9
 - format 25-7, 25-8
 - status 25-7, 25-20
 - code 25-20
 - timeout 25-14, 25-19
- repeat
 - cycles 4-9, 25-4, 25-10
 - designation 4-9
 - operation
 - ADD and SUB instructions 8-6
 - ANDW, ORW, and XORW instructions 9-3
 - data comparison instructions 7-4
 - DIV instruction 8-10
 - indirect bit move instruction 6-11
 - move instructions 6-3
 - MUL instruction 8-8

- reset
 - input 5-22
- restore timer/counter preset values 5-17
- restriction on ladder programming 5-31
- reverse
 - shift register 5-24
- Reversible control 19-18, 19-37
- ROOT 8-14
- rotate
 - left 10-8
 - right 10-10
- ROTL 10-8
- ROTR 10-10
- RS232C
 - control signal status 3-13
 - DSR input control signal option 3-14
 - DTR output control signal option 3-14
- rung 1-3, 1-4
- RXD 25-7

S

- Script (SCRPT) 27-1
- SD Memory Card
 - Capacity 3-12
- sec to HMS 24-10
- server
 - connection (1 through 3) connected IP address D8110-D8121 3-14
- SET and RST instructions 5-3
- SFR and SFRN instructions 5-22
- SFTL 10-1
- SFTR 10-3
- shift
 - left 10-1
 - register
 - instructions 5-22
 - right 10-3
- shift/rotate instructions 10-1
- simulate operation 1-7
- SIN 21-3
- sine 21-3
- single output instruction 5-26
- Skip 25-16
- SOTU and SOTD instructions 5-26
- SOTU/SOTD instructions using with program branching 14-2
- source
 - and destination devices 4-9
 - device 4-9
- special data register 3-8
- special dates 12-11
- special internal relay 3-2
 - for interrupt status 16-1
 - for receive instruction cancel flag 25-20
- specified date 12-11
- start
 - control M8000 3-5
 - delimiter 25-10
 - multi-byte 25-11
 - WindLDR 1-1, 1-3
- status
 - code
 - receive 25-20
 - transmit 25-6
- STOH 24-10

- structure of an advanced instruction 4-9
 - SUB 8-1
 - subnet mask D8088-D8091 3-13
 - subroutine 14-4
 - subtraction 8-1
 - SUM 8-15
 - sum 8-15
 - SWAP 11-23
 - system
 - program
 - version D8029 3-12
 - setup
 - ID quantity of inputs D8000 3-11
 - ID quantity of outputs D8001 3-11
- T**
- TADD 24-1
 - TAN 21-5
 - tangent 21-5
 - TCCST 6-16
 - teaching timer 20-3
 - time
 - addition 24-1
 - subtraction 24-5
 - timer
 - 100-ms off-delay 5-10
 - 10-ms off-delay 5-10
 - 1-ms off-delay 5-10
 - 1-sec off-delay 5-10
 - accuracy 5-8
 - instruction using with program branching 14-2
 - interrupt
 - status M8144 3-7
 - or counter
 - as destination device 4-9
 - as source device 4-9
 - timer/counter
 - current value
 - store 6-16
 - TML, TIM, TMH, and TMS instructions 5-7
 - TMLO, TIMO, TMHO, and TMSO instructions 5-10
 - TRACE 26-8
 - transmit 25-1
 - bytes 25-4
 - completion output 25-6
 - data 25-2
 - byte count 25-7
 - digits 25-4
 - status 25-6
 - code 25-6
 - trigonometric function instructions 21-1
 - TSUB 24-5
 - TTIM 20-3
 - TXD 25-1
- U**
- up
 - counter CNT 5-11
 - up/down selection reversible counter CUD 5-13
 - USB 1-7
 - user
 - communication
 - constant 25-15
 - instructions 25-1
 - multi-byte start delimiter 25-11
 - receive instruction cancel flag
 - M8100-M8102 3-6
 - port 2 M8022 3-5
 - port 3 M8023 3-5
 - program
 - execution error
 - M8004 3-5
 - User Program Execution Errors 4-13
- V**
- version
 - system program D8029 3-12
- W**
- WindLDR
 - programming
 - DI or EI 16-2
 - quit 1-8
 - start 1-1, 1-3
 - word shift 10-7
 - WSFT 10-7
- X**
- XCHG 6-15
 - XORW 9-1
 - XY format set 17-1
 - XYFS 17-1